

LIST PRICER

SPACE®
PRO·LINE II®
OSP FURNITURE®
WORK SMART®



JAN
2019
Supersedes
JULY 2018
version
B

Table of Contents

Chair Finder	4-5	Space® Seating Warranty Information.....	205
Fabrics and Finishes	191-202	Pro•Line II® Warranty Information	205
General Information	203	Work Smart® and General Warranty Information.....	206
OSP® Furniture Lounge, Office Seating and Casegoods Warranty Information.....	204	Multi Purpose Table and Chair Warranty Information	206
		Seating Feature Information	207



13 Series	7-9
15 Series	9
23 and 24 Series (New)	9-10
25 and 27 Series	10
32 Series	11
36 Series (3680 series).....	12
37 Series	13
52 Series (includes 5200W)	25
55 Series (Includes 5500 series) (New)	14-16
57 Series/5700 Series.....	16-17
62 Series (6216, 6236)	19
63 Series (New).....	19
67 Series (New).....	20
68 Series	20-21
75 Series (Big and Tall)	21
86 Series (REVV®).....	22-23
86W Series	23
Pulsar Series	24-25
93 Series (9333E Deluxe Conference)	25, 30
213 Series	8, 17-18
215 Series	26
317 Series	26-27
317W Series	25
327 Series	12-13
335 Series	27
529 Series (New).....	27-28
657 Series (New).....	28-29
818 and 818A Series.....	29-30
839 Big and Tall	30
848 Series (848W).....	25
9370 Series	30
Options	31
Fabrics and Backs	32
Space Arms.....	33



Custom Upholstery Lounge Seating	35-37
Lounge Seating (New)	38-43
Ascend II Active Seating (New)	44-45
Office Seating (New).....	46
Wood Guest Seating	47-49
SIS - Systems in Stock (New)	50-53
Kenwood	57
Sonoma	60
Townsend	63
Mendocino	66
Intelligent Tables	68
Tuxedo.....	70-72
Napa	73-79
Lodi	82
Multipurpose (matches Napa & Lodi laminates)	83-85
P.H.A.T. (Pneumatic Height Adjustable Tables)	92-94
Multipurpose Desk Riser	95
Ascend II Electric Height Adjustable Tables (New).....	86-91
Napa Multi-Position Desk Riser	96
Folding/Nesting Training Tables	98-100
Pace.....	101-103
Metal Files, Storage & Pedestals	104-107
Casegood Details	108-110



39200's Big and Tall	112
69220 Series	112
Pro X996 Series	112-114
HR3 Series	114
SPX Series	115
7270's Leather Executive Series	115-116
8200's & 8500's Leather Executive Series	116
Executive Ergonomic	117
ProGrid® Mesh Back	117-122
Deluxe Stacking Chair	122-124
Deluxe Folding/Training Chairs	125
Options	126
ProGrid® Mesh Folding Chairs	126
Height Adjustable Table	127
Desks, Bookcase, & File: Horizon	128
Desks, Bookcase, & File: Prado (New)	129-131



Ergonomic Fabric	133-135
Ergonomic Leather	135
Pneumatic Task Chairs	135-136
Specialty Seating	136
Executive Seating - Fabric	137
Bariatric Seating	138
Executive Seating - Big Man's	138
Executive Seating - Bonded Leather	139
Executive Seating - Bonded Leather & Coated Base	140-142
Executive Seating - Leather	142-143
Executive Seating - Faux Leather/Chrome Base (New)	143-145
Reception Tables	147-149
Reception Seating	149-153
Reception Seating - Wood (New)	153-156
Reception Seating - Wood Modular	156-158
Reception Tables - Merge	158-159
Traditional Executive/Reception Seating	159-161
Drafting Chairs (New)	161-165
Visitor's Chairs	165
Stack Chairs	166-168
Rental Chairs	168
Folding Chairs	169-170
Ventilated Seating (New)	171-174
Self-Skinned Urethane Seating	174-176
Arm Kits, Floor Glides, Casters and Stool Kit Options	176
Breakroom Collection	178-179
Multi Purpose Tables and Chairs (New)	181-184
Caddies and Dollies	184
◆ Light Duty Seating	186-189

FABRICS

A Grade Fabrics	191-194
B Grade Fabrics	195-198
C Grade Fabrics (New)	199
R Grade Fabrics	200
Other Fabrics and Finishes	201-202
Metals Frames/Finishes (New)	202

All natural wood products are subject to variations in color finishes from different manufacturers and may not exactly match with each other.

Items marked with "★" are New Jersey stocking items. Items marked with "⚙️" are TAA Compliant.

**All Measurements and Weights are nominal * Prices subject to change without notice

Due to changing costs not within our control, which include but are not limited to import tariffs, government mandated costs both domestically and from factory country of origin, costs of raw materials, costs of transportation, and manufacturing costs, while providing a 30 day notice, Office Star® Products reserves the right to change prices accordingly.

Space®

13-7N1P3.....	7
13-7N9WA.....	7
13-7N20D.....	7
13-37N1P3.....	7
13-37N9WA.....	7
13-37N20D.....	7
13-37N30D.....	8
13-37P500D.....	8
13-77N1P3.....	8
13-77N9WA.....	8
13-77N30D.....	8
13-88N1P3.....	9
13-V22N1WA.....	9
13-V44N1WA.....	9
13-V66N1WA.....	9
13-V77N1WA.....	9
13-V88N1WA.....	9
15-37A720D.....	9
23-77N1F2.....	9
32-E33P91A7.....	11
32-E33P91A7HL.....	11
32-E33P918P.....	11
32-E33P918PHL.....	11
32-E3371F3.....	11
32-E3371F3HL.....	11
37-33N1A7U.....	13
55-7N17.....	13
55-7V30.....	13
55-38N17.....	13
55-38V30.....	15
55-88N15.....	13
55-M22N17.....	14
63-37A773HM.....	19
63-E3T17C63C.....	19
63-E37A773HL.....	19
63-T117C63C.....	19
67-37N1G5.....	20
67-66N61R5.....	20
67-77N1G5.....	20
67-E36N61R5.....	20
68-50764.....	20
75-7A773.....	21
75-37A773.....	21
75-47A773.....	21
86-M22C625R.....	22
86-M32C625R.....	22
86-M33BN2W.....	22
86-M33C625R.....	22
86-M34C625R.....	22
86-M35C625R.....	22
86-M39C625R.....	23
86-M66C625R.....	23
86-M74C625R.....	23
86-M77C625R.....	23
86-M88C625R.....	23
86W-2C12F2W.....	23
213-37N2F3D.....	8
213-37P91A7.....	17
213-38N1F3.....	17
213-88N1F3.....	17
213-E37P91A7.....	18
213-E37P91F3.....	17
213-J11N1W.....	18
213-J44N1W.....	18
213-J77N1W.....	18
213-J88N1W.....	18
213-J99N1W.....	18
215-3R2C62R5.....	25
215-E3T17C1A8.....	26
215-TG117C1A8.....	26

317-66C61F6.....	27
317-ME3R2C6KF6.....	26
317-ME3R2C7KF7.....	26
317-ME36C61F6.....	27
317-R22C6KF6.....	26
317-R22C7KF7.....	26
317W-W1C1F2W.....	25
317W-W11C1F2W.....	25
327-66C61F6.....	12
327-66C61F6HL.....	13
327-E36C61F6.....	12
327-E36C61F6HL.....	12
335-E37P918P.....	27
529-3R2N1F2.....	27
529-3R2V30.....	28
529-E3R2N1F2.....	28
529-E3R2V30.....	28
529-M3R2N6F2.....	27
529-ME3R2N6F2.....	27
529-R2N1F2.....	28
529-R22N1F2.....	28
657-3TW1N1421W.....	28
657-7TG1N4421G.....	29
657-E3T17C63C.....	29
657-T11N6421R.....	29
818-11G9C18P.....	29
818-31G9C18P.....	29
818-41G9C18P.....	29
818A-11P9C1A8.....	30
818A-41P9C1A8.....	30
839-11B35WA.....	30
848W.....	25
2160SL.....	17
2300.....	10
2400E.....	10
2787.....	10
3680.....	12
3685.....	12
5200W.....	25
5500®.....	14
5500SL.....	14
5500V.....	15
5505.....	15
5540.....	15
5560.....	15
5565.....	16
5700E®.....	16
5700SL.....	16
5705E.....	16
5790E.....	16
6216.....	19
6236.....	19
6806.....	20
6876.....	21
9333E.....	25
9370-55NC17U.....	30
25004.....	10
27008.....	10
27876.....	10
36806.....	12
55403.....	16
57906E.....	17
A7U.....	31
A15.....	31
A27WA.....	31
CG50.....	31
EHLR006.....	31
HRL818.....	31
HRM003.....	31
HRM818.....	31
HRX818.....	31

OSP® Furniture

SW70.....	31
SW392.....	31, 176
51831HA-EC3.....	46
51911HC-EC3.....	46
51911MC-EC3.....	46
518317HA-EC3.....	46
519117HC-EC3.....	46
519117MC-EC3.....	46
ACT1010.....	44
ACT1011.....	44
ACT3020.....	45
ACT3120.....	45
ACT4220.....	45
ATL51.....	36
ATL52.....	36
ATL53.....	36
KEN-99-LCH.....	48
KEN-99-MAH.....	48
KEN-129-LCH.....	48
KEN-129-MAH.....	48
KEN-992-LCH.....	48
KEN-992-MAH.....	48
KEN-1292-LCH.....	48
KEN-1292-MAH.....	48
MST51.....	37
MST52.....	37
MST53.....	37
MUP51.....	39
NAP91.....	47
NAP95.....	47
NAP97.....	47
PAC51.....	35
PAC52.....	35
PAC53.....	35
SF8471.....	38
SF8472.....	38
SF8473.....	38
SL2271.....	39
SL2272.....	39
SL2273.....	39
SL2371EC9.....	40
SL2372EC9.....	40
SL2373EC9.....	40
SL2571U1.....	40
SL2572U1.....	40
SL2573U1.....	40
SL2811.....	41
SL2812.....	41
SL2813.....	41
SL2911S-U6.....	42
SL2912S-U6.....	42
SL2913S-U6.....	42
SL4001.....	42
SL4002.....	42
SL4003.....	42
SL4411.....	38
SL4422.....	38
SL4433.....	38
SL8471.....	43
SL8472.....	43
SL8473.....	43
SL8872.....	43
SL9941-EC3.....	43
SL9942-EC3.....	43
SL9943-EC3.....	43
SON-99-CHY.....	49
SON-129-CHY.....	49
SON-992-CHY.....	49
SON-1292-CHY.....	49

Pro•line II®

SW392.....	46
TWN300L-3.....	62
2817.....	117
2902.....	118
7270.....	115
7271.....	115
7275.....	116
8200.....	116
8201.....	116
8205.....	116
8455.....	123
8500.....	116
8501.....	116
8505.....	117
8511.....	117
8512.....	117
8610.....	124
8620.....	124
8640.....	124
8810W.....	120
8840W.....	120
28174.....	117
29024.....	118
39200.....	112
39203.....	112
54666.....	117
69220C-EC3.....	112
69226-EC3.....	112
69227-3M.....	112
80885AL.....	119
81101.....	126
81308.....	126
81608.....	126
82710.....	123
82720.....	123
82740.....	124
83220.....	125
84220.....	125
84230.....	125
84270.....	125
84330.....	125
84440.....	125
84510.....	122
84540.....	123
85640.....	122
85670.....	122
86710.....	124
86724.....	123
86725.....	123
86740.....	124
90662.....	121
92343.....	119
92583.....	121
92892.....	121
92893.....	119
93720.....	121
95512.....	121
95672.....	120
95673.....	120
96610.....	118
97720.....	122
97728.....	122
98341.....	118
98344.....	118
98346.....	122
99661W.....	112
99662C.....	113
99663B.....	113
99666S.....	113

99667T.....	113
511342AL.....	118
511343AT.....	119
CG60.....	126
HAT60241.....	127
HAT60251.....	127
HAT60261.....	127
HB4GLIDE.....	94, 127
HR31W.....	114
HR33B.....	114
HR36S.....	114
HRX52.....	119
HRX53.....	119
HZN25.....	128
HZN25L.....	128
HZN30.....	128
PHT70521.....	127
PHT70523.....	127
PHT70527.....	127
PRD42RT.....	131
PRD2415.....	130
PRD3060.....	129
PRD3060D.....	129
PRD3085.....	131
PRD3230.....	131
PRD3248.....	131
PRD3260.....	131
PRD3529.....	130
PRD5215.....	130
PRD6024.....	129
PRDFLAT.....	130
PRDPOW1.....	130
PRDWIRE32.....	130
SPX23590C.....	115
SPX23591C.....	115
SPX23592C.....	115
SPX23595C.....	115
SW70.....	126
SW72.....	126

Work Smart®

04-ARMS-3.....	176
07-ARMS-3.....	176
2907.....	134
3121.....	134
3121FB.....	134
3121TB.....	134
8120.....	136
8180.....	134
33101.....	135
33107.....	136
33320.....	133
33327.....	133
33340.....	133
33347.....	133
36420.....	133
36427.....	133
41572.....	137
41573.....	137
41575.....	137
43808.....	135
43819.....	135
43891.....	134
43998.....	135
69906-2.....	171
69906-3.....	171
92553.....	119
183305.....	168
183905.....	168
583713.....	189

583814	189	EC8124	139	EX35	165	MRG07R1	159	TEX220	159
599302	173	EC9230	139	EX1098-3M	138	MRG09	158	TEX228	160
599402	174	EC9231	139	EX2651	137	MRG09S	159	TEX232	160
ATH51	151	EC9235	139	EX2654	137	MRG12	158	TEX234	160
ATH51CG	151	EC22070	187	EX2655	137	MRG12R	159	TND940A	136
ATH52	151	EC51832MC	144	EX3301	187	MRG12SR1	159	TND941A	136
ATH52CG	151	ECH8967K5-EC1	140	EX3302	187	MST51	155	TND945A	136
ATL51	153	ECH8967R5-EC3	140	EX5161	142	MST52	155	TSX1121	161
ATL52	153	ECH12801-EC1	138	EX5162	143	MST53	155	TSX1122	161
ATL53	153	ECH31826-EC3	140	FC8000NB	169	MST55	154	TSX1123	161
BC9601	138	ECH31827-EC3	140	FC8000NBG	169	NVA51	152	TV230-3	160
BC9602	138	ECH31827-EC6	140	FC8000NP	169	OPH61601-EC1	142	TV230-JT4	160
BC9603	138	ECH37811-EC1	140	FC8000NS	169	OPH61601-EC6	142	TV231-3	160
BRW29A2	178	ECH37816-EC3	140	FC8000NW	170	OPH61606-EC3	142	TV231-JT4	160
BRW29A4	178	ECH37817-EC3	140	FC8100NBG	170	OPH61607-EC3	142	TV233	160
BRW3026A2	179	ECH38615A-EC1	141	FC8100NP	170	OPH62606-EC3	142	V3460	165
BRW3026A4	179	ECH38665A-EC3	141	FC8100NS	170	PAC51	152	V4410	165
BRW3030A2	179	ECH38675A-EC3	141	FC8483-231	169	PAC52	152, 153	V4420	166
BRW3030A4	179	ECH68801-EC1	141	FC8487-231	169	PAC53	152, 153	VVN	154
BT04FA	181	ECH68807-EC3	141	FF-22124M	170	PC-02	183	WA383	157
BT04Q	181	ECH70531-EC1	141	FF-22324M	170	PC-03	183	WA387	157
BT04W	182	ECH70536-EC3	141	FF-23124V	170	PC-15F	184	WA388	157
BT5FQW	182	ECH70537-EC3	141	FF-23324V	170	PC-54	183	WC7287	168
BT05Q	182	ECH70751-EC31	141	FL605	146	PCT-05	183	WD380	156
BT06A	182	ECH70756-EC3	141	FL660	145	PTR2830A2	178	WD383	157
BT6FQ	182	ECH75001-EC1	140	FL1033	146	PTR2830A4	178	WD387	157
BT6FQW	182	ECH75006-EC3	140	FL1055	146	PTR3024A2	178	WD388	157
BT06Q	182	ECH76501-EC1	141	FL1327C	143	PTR3024A4	178	WD483	153
BT08Q	182	ECH76506	141	FL2604C	145	PTR3030A2	178	WD1353	158
BT22	183	ECH83501-EC1	141	FL5380C	144	PTR3030A4	178	WD1357	158
BT36	182	ECH83507-EC3	141	FL5385C	145	QT3965	183	WD1358	158
BT48Q	182	ECH89181-EC1	142	FL5388C	145	QT7205-05	183	WDN51	156
BT60Q	183	ECH89181-EC6	142	FL7480	187	QT7302-03	183	WST07	148
BT71Q	183	ECH89186-EC3	142	FL7481	187	RC88	168	WST07-BK	148
BT244	181	ECH89187-EC3	142	FL7485	188	RHD51	155	WST07-WH	148
CG50	176	ECH89301-EC1	142	FL9097	146	RLY26-WH	171	WST09	148
CG60	176	ECH89307-EC3	142	FL22991G	145	SC66	186	WST09-BK	148
CHA51	155	ECH91211-EC1	140	FL23591G	145	SC117	186	WST09-WH	148
CPR51	154	ECH91216-EC3	140	FL27513C	143	SHE	154	WST12	148
DC420V-3	188	ECH91217-EC3	140	FL38610	147	SK-5	176	WST12-BK	148
DC430	162	ECH91231-EC1	140	FL38610C	144	SK-7	176	WST12-WH	148
DC517	163	ECH91236-EC3	140	FL38640	147	SPX61522-3	171	WST16-BK	148
DC517V	163	ECH91237-EC3	140	FL38640C	144	ST203	162	WST16-ESP	148
DC550	163	EM2910	189	FL80287C	143	ST205	162	WST16-WH	148
DC630	163	EM2910V	189	FL89675	146	ST215	161	WST17	148
DC640	163	EM5972V-3	174	FL90071C	143	ST217	162	WST17-BK	148
DC800	163	EM5972V-EC3	174	FL92011C	144	ST235V-3	188	WST17-WH	148
DC940	164	EM20700-F3	188	FL92017C	144	ST428V-3	188	WST51A	149
DC2990	164	EM20722-F3	188	FL92970C	143	STC865	167	WST51C	150
DC2990V	164	EM22800	189	FLH24981-U1	146	STC866	167	WST51LF	149
DC6900WH	165	EM22822	189	FLH24987-U6	146	STC3030	166	WST51N	149
DC8309C	167	EM35201-EC1	173	FT6634	181	STC3030C30	166	WST51OP	150
DC8658C	167	EM35206-EC3	173	FT6635	181	STC3230	166	WST51P	150
DC51000N	164	EM35207-3	173	KCM1420	186	STC3410	166	WST51RF	150
DC51000NV	164	EM50219-3V	173	KCM1425	186	STC3440	166	YLD07	148
DCY69006	165	EM50727	173	KCW773	186	STC8300	167	YLD09	149
DCY69200PC	164, 172	EM51022N	173	KCW778	186	STC8302	167	YLD12	149
DH3400	136	EM59722	174	KH206	174	STX8310AC2	168	YLD17	149
DOL865	184	EM59722-EC3	174	KH503	175	STX8310AC4	168	YLD5130	151
DOL8000	184	EM69200PN	171	KH507	175	STX8310AC13	168	YLD5141	152
DOL8300	184	EM69202N	171	KH520	175	SW70	176		
DOL8302	184	EM69203C	172	KH540	175	SW72	176		
DOR26	186	EMH6918T	172	KH550	175	TBB2020	161		
DVS51	155	EMH6921C-EC3	172	KH570	176	TBB4020	161		
DVS52	156	EMH69096-3	189	KH580	175	TC102	184		
EC1283C-EC3	138	EMH69176	172	LS481C	151	TC103	184		
EC3393	187	EMH69203S	171	MAE	154	TC104	184		
EC4300	135	EMH69216-3M	172	MG0920R-NB	147	TC106	184		
EC4350	135	EMH69216-U6	172	MG0922S-NB	147	TC8310D	168		
EC6582	139	ETN	154	MG1230R-NB	147	TC8815	168		
EC6583	139	EX31	165	MG1242S-NB	147	TC8860	168		



657-E3T17C63C

S P A C E[®]
S E A T I N G

solutions for every atmosphere[®]

Space[®] Seating leads the industry by offering innovative, ergonomic seating solutions for commercial environments. Made with the highest quality standards and equipped with the latest multi-functional capabilities, Space[®] Seating will exceed expectations at an impressive price point. Includes a limited lifetime warranty.



⚙️ **13-7N1P3** Deluxe Air Grid® Back Chair with Custom Fabric Seat, Cantilever Arms and Angled Nylon Base

Overall Size: 27W x 24D x 41.25H
Seat: 19.5W x 20D x 4T **Back:** 20W x 19H **Seat Range:** 19 - 23.5
Arms to Floor: 25.5 **Carton Wt:** 41 **UPS Wt:** 50 **COM:** 1 yd.
Carton: 29L x 27W x 13H **Cube:** 5.89
Options: SW392 **Features:** 1, 4, 7, 8, 9 **Control:** 2-to-1 Synchro Tilt
Notes:



Fabric	List Price
Air Grid® Back and Custom Fabric Seat	
A	450.00
B	470.00
C	495.00
R	525.00



⚙️ **13-7N9WA** Deluxe Air Grid® Back Chair with Custom Fabric Seat, 2-Way Adjustable Arms, Seat Slider and Angled Nylon Base

Overall Size: 27W x 24D x 41.25H
Seat: 19.5W x 20D x 4T **Back:** 20W x 19H **Seat Range:** 19 - 23.5
Arms to Floor: 25.5 **Carton Wt:** 43 **UPS Wt:** 48 **COM:** 1 yd.
Carton: 29L x 26W x 13H **Cube:** 5.67
Options: SW392 **Features:** 1, 3, 4, 9, 13, 15 **Control:** Multi-Function w/Seat Slider
Notes: No Ratchet Back



Seat Slider

Fabric	List Price
Air Grid® Back and Custom Fabric Seat	
A	510.00
B	530.00
C	555.00
R	595.00



⚙️ **13-7N20D** Deluxe Air Grid® Back Drafting Chair with Custom Fabric Seat, Adjustable Footring and Nylon Base

Overall Size: 21.25W x 25.5D x 51H
Seat: 19.5W x 20D x 4T **Back:** 20W x 19H **Seat Range:** 27.5 - 32.5
Arms to Floor: N/A **Carton Wt:** 37 **UPS Wt:** 52 **COM:** 1 yd
Carton: 28L x 27W x 14H **Cube:** 6.12
Options: A15 Arms, CG50, SW70 **Features:** 1, 4 **Control:** Pneumatic Seat Height
Notes:



Fabric	List Price
Air Grid® Back and Custom Fabric Seat	
A	515.00
B	535.00
C	560.00
R	600.00



★ **13-37N1P3** Deluxe Air Grid® Back Chair with Mesh Seat, Cantilever Arms and Angled Nylon Base

Overall Size: 27W x 24D x 41.25H
Seat: 19.5W x 20D x 4T **Back:** 20W x 19H **Seat Range:** 19 - 23.5
Arms to Floor: 25.5 **Carton Wt:** 38 **UPS Wt:** 46 **COM:** 1 yd.
Carton: 27L x 26W x 14H **Cube:** 5.68
Options: SW392 **Features:** 1, 4, 7, 8, 9 **Control:** 2-to-1 Synchro Tilt
Notes: Available in Fun Colors - see page 24.



Fabric	List Price
Air Grid® Back & Black Mesh Seat	435.00
FUN COLORS FABRIC PROGRAM (Seat only)	455.00



★ **13-37N9WA** Deluxe Air Grid® Back Chair with Mesh Seat, 2-Way Adjustable Arms, Seat Slider and Angled Nylon Base

Overall Size: 27W x 24D x 41.25H
Seat: 19.5W x 20D x 4T **Back:** 20W x 19H **Seat Range:** 19 - 23.5
Arms to Floor: 25.5 **Carton Wt:** 45 **UPS Wt:** 48 **COM:** 1 yd.
Carton: 29L x 26W x 13H **Cube:** 5.67
Options: SW392 **Features:** 1, 3, 4, 9, 13, 15 **Control:** Multi-Function w/Seat Slider
Notes: No Ratchet Back. Available in Fun Colors - see page 24.



Fabric	List Price
Air Grid® Back & Black Mesh Seat	495.00
FUN COLORS FABRIC PROGRAM (Seat only)	515.00



★ **13-37N20D** Deluxe Air Grid® Back Drafting Chair with Black Mesh Seat, Adjustable Footring and Nylon Base

Overall Size: 21.25W x 25.5D x 51H
Seat: 19.5W x 20D x 4T **Back:** 20W x 19H **Seat Range:** 27.5 - 32.5
Arms to Floor: N/A **Carton Wt:** 37 **UPS Wt:** 52 **COM:** 1 yd.
Carton: 28L x 27W x 14H **Cube:** 6.12
Options: A15 Arms, CG50, SW70 **Features:** 1, 4 **Control:** Pneumatic Seat Height
Notes: Available in Fun Colors - see page 24.



Fabric	List Price
Air Grid® Back & Black Mesh Seat	495.00
FUN COLORS FABRIC PROGRAM (Seat only)	515.00

13 and 213 Series



★ **13-37N30D** Deluxe Air Grid[®] Back Drafting Chair with Black Mesh Seat, Dual Function Control, Adjustable Footring and Angled Nylon Base
 ⚙️
 🌿 **Overall Size:** 20W x 26D x 45H
Seat: 19.5W x 20D x 4T **Back:** 20W x 19H **Seat Range:** 19.75-27.25
Arms to Floor: N/A **Carton Wt:** 40 **UPS Wt:** 52 **COM:** N/A
Carton: 28L x 27W x 14H **Cube:** 6.12
Options: A15 Arms, CG50, SW70 **Features:** 1, 4, 11 **Control:** Dual Function
Notes:

Fabric	List Price
Air Grid [®] Back and Black Mesh Seat	550.00



★ **13-37P500D** Deluxe Air Grid[®] Back Drafting Chair with Black Mesh Seat, Adjustable Footring, Chrome Finish Base and Accents
 ⚙️
 🌿 **Overall Size:** 21.25W x 25.5D x 51H
Seat: 19.5W x 20D x 4T **Back:** 20W x 19H **Seat Range:** 27.5 - 32.5
Arms to Floor: N/A **Carton Wt:** 37 **UPS Wt:** 52 **COM:** N/A
Carton: 28L x 27W x 14H **Cube:** 6.13
Options: A15 Arms, SW392 **Features:** 1, 4 **Control:** Pneumatic Seat Height
Notes:

Fabric	List Price
Air Grid [®] Back and Black Mesh Seat	550.00



⚙️ **13-77N1P3** Deluxe Air Grid[®] Seat and Back Chair with Cantilever Arms
 🌿 **Overall Size:** 27W x 24D x 41.25H
Seat: 20W x 20D **Back:** 20W x 19H **Seat Range:** 19 - 23.5
Arms to Floor: 25.5 **Carton Wt:** 43 **UPS Wt:** 50 **COM:** N/A
Carton: 29L x 27W x 13H **Cube:** 5.89
Options: SW392 **Features:** 1, 4, 7, 8, 9 **Control:** 2-to-1 Synchro Tilt
Notes:

Fabric	List Price
Air Grid [®] Seat and Back	465.00



★ **13-77N9WA** Deluxe Air Grid[®] Seat and Back Chair with Dual-Function Control, Seat Slider and 2-Way Adjustable Arms
 ⚙️
 🌿 **Overall Size:** 26.5W x 28.25D x 42.5H
Seat: 20W x 20D **Back:** 20W x 19H **Seat Range:** 19 - 23.5
Arms to Floor: 26.25 **Carton Wt:** 43 **UPS Wt:** 50 **COM:** N/A
Carton: 29L x 27W x 13H **Cube:** 5.89
Options: SW392 **Features:** 1, 4, 9, 11, 15 **Control:** Dual Function w/Seat Slider
Notes:

Fabric	List Price
Air Grid [®] Seat and Back	595.00

Seat Slider



★ **13-77N30D** Deluxe Ergonomic Air Grid[®] Seat and Back Drafting Chair with Dual Function Control, Adjustable Footring and Nylon Base
 ⚙️
 🌿 **Overall Size:** 20W x 26D x 45H
Seat: 20W x 20D **Back:** 20W x 19H **Seat Range:** 19.5 - 27
Arms to Floor: N/A **Carton Wt:** 41 **UPS Wt:** 46 **COM:** N/A
Carton: 28L x 26W x 13H **Cube:** 5.47
Options: A15 Arms, CG50, SW70 **Features:** 1, 4, 9, 11 **Control:** Dual Function
Notes:

Fabric	List Price
Air Grid [®] Seat and Back	595.00



★ **213-37N2F3D** Deluxe Air Grid[®] Back and Padded Mesh Seat Chair with 4-Way Adjustable Flip Arms **Included**
 ⚙️
 🌿 **Overall Size:** 27.5W x 23.75D x 48.25H
Seat: 20.5W x 19.25D x 3.5T **Back:** 21.25W x 21.25H **Seat Range:** 20 - 27.5
Arms to Floor: 27.75 **Carton Wt:** 42 **UPS Wt:** 50 **COM:** N/A
Carton: 30L x 26W x 13H **Cube:** 5.86
Options: CG50, SW70 **Features:** 1, 4 **Control:** Pneumatic Seat Height
Notes:

Fabric	List Price
Air Grid [®] Back and Black Mesh Seat	600.00



⚙️ **13-88N1P3** Deluxe Latte Air Grid® Seat and Back Chair with Cantilever Arms

🌱 **Overall Size:** 27W x 24D x 41.25H
Seat: 20W x 20D **Back:** 20W x 19H **Seat Range:** 19 - 23.5
Arms to Floor: 25.5 **Carton Wt:** 43 **UPS Wt:** 50 **COM:** N/A
Carton: 29L x 27W x 13H **Cube:** 5.89
Options: SW392 **Features:** 1, 4, 7, 8, 9 **Control:** 2-to-1 Synchro Tilt
Notes:

Fabric	List Price
Latte Air Grid® Seat and Back	465.00



★ **13-V22N1WA/13-V77N1WA** Deluxe Chair with VeraFlex® Back 2-to-1 Synchro Tilt Control and 2-Way Adjustable Arms

⚙️ **Overall Size:** 27W x 26.5D x 40H
Seat: 19.5W x 20D x 4T **Back:** 20W x 19H **Seat Range:** 17.75-22.5
Arms to Floor: 25.5 **Carton Wt:** 39 **UPS Wt:** 48 **COM:** N/A
Carton: 27L x 26W x 14H **Cube:** 5.68
Options: SW392 **Features:** 1, 4, 7, 8, 9 **Control:** 2-to-1 Synchro Tilt
Notes:

Fabric	List Price
13-V22N1WA Shadow VeraFlex® Seat and Back	440.00
13-V77N1WA Blue Mist VeraFlex® Seat and Back	



★ **13-V44N1WA/13-V88N1WA** Deluxe Chair with VeraFlex® Back 2-to-1 Synchro Tilt Control and 2-Way Adjustable Arms

⚙️ **Overall Size:** 27W x 26.5D x 40H
Seat: 19.5W x 20D x 4T **Back:** 20W x 19H **Seat Range:** 17.75-22.5
Arms to Floor: 25.5 **Carton Wt:** 39 **UPS Wt:** 48 **COM:** N/A
Carton: 27L x 26W x 14H **Cube:** 5.68
Options: SW392 **Features:** 1, 4, 7, 8, 9 **Control:** 2-to-1 Synchro Tilt
Notes:

Fabric	List Price
13-V44N1WA Charcoal VeraFlex® Seat and Back	440.00
13-V88N1WA Latte VeraFlex® Seat and Back	



★ **13-V66N1WA** Deluxe Chair with VeraFlex® Back 2-to-1 Synchro Tilt Control and 2-Way Adjustable Arms

⚙️ **Overall Size:** 27W x 26.5D x 40H
Seat: 19.5W x 20D x 4T **Back:** 20W x 19H **Seat Range:** 17.75-22.5
Arms to Floor: 25.5 **Carton Wt:** 39 **UPS Wt:** 48 **COM:** N/A
Carton: 27L x 26W x 14H **Cube:** 5.68
Options: SW392 **Features:** 1, 4, 7, 8, 9 **Control:** 2-to-1 Synchro Tilt
Notes:

Fabric	List Price
Kiwi VeraFlex® Seat and Back	440.00



★ **23-77N1F2** Professional Dark Air Grid® Back and Seat Manager's Chair with Adjustable Flip Arms, Adjustable Lumbar and Nylon Base

⚙️ **Overall Size:** 27.5W x 26D x 41.5 - 45.5H
Seat: 21.5W x 19.75D x 3T **Back:** 22.5W x 24.25H **Seat Range:** 18.5-22.5
Arms to Floor: 25.5 **Carton Wt:** 47 **UPS Wt:** 47 **COM:** N/A
Carton: 31L x 26W x 12H **Cube:** 5.59
Options: CG50, SW70 **Features:** 1, 4, 7, 8, 9 **Control:** 2-to-1 Synchro Tilt
Notes:

NEW

Fabric	List Price
Air Grid® Seat and Back	595.00



★ **15-37A720D** Dual Layer Air Grid® Back Drafting Chair with Black Mesh Seat, Adjustable Footring and Gunmetal Finish Base

⚙️ **Overall Size:** 21.5W x 25.5D x 54.5H
Seat: 21.5W x 20D x 4T **Back:** 20.5W x 22.5H **Seat Range:** 28 - 33
Arms to Floor: N/A **Carton Wt:** 45 **UPS Wt:** 51 **COM:** N/A
Carton: 31L x 26W x 13H **Cube:** 6.06
Options: A27WA Arms, CG50, SW70 **Features:** 1, 4 **Control:** Pneumatic Seat Height
Notes: Big and Tall 325 lbs. Rating **Optional A27WA Arms Available**

Fabric	List Price
Dual Layer Dark Air Grid® Back and Black Mesh Seat	595.00
Big & Tall 325 lbs.	



★ **2300** Breathable Mesh Back and Mesh Seat Manager's Chair with Adjustable Arms, Adjustable Lumbar and Gunmetal Finish Base
 Overall Size: 27.25W x 25.75D x 46.25H
 Seat: 20W x 19.5D x 3T Back: 22.5W x 24.5H Seat Range: 18.5-22.75
 Arms to Floor: 25 Carton Wt: 48 UPS Wt: 48 COM: N/A
 Carton: 31L x 26W x 12H Cube: 5.59
 Options: CG50, SW70 Features: 1, 4, 7, 8, 9 Control: 2-to-1 Synchro Tilt
 Notes:

Fabric	List Price
Breathable Mesh Back and Black Mesh Seat	615.00



★ **2400E** Breathable Mesh Back and Bonded Leather Seat Manager's Chair with Adjustable Arms, Adjustable Lumbar and Gunmetal Finish Base
 Overall Size: 27.25W x 25.75D x 46.25H
 Seat: 20W x 19.5D x 3T Back: 22.5W x 24.5H Seat Range: 18.5-22.75
 Arms to Floor: 25 Carton Wt: 48 UPS Wt: 48 COM: N/A
 Carton: 30L x 27W x 12H Cube: 5.62
 Options: CG50, SW70 Features: 1, 4, 7, 8, 9 Control: 2-to-1 Synchro Tilt
 Notes: 2400E Replaces 2400

Fabric	List Price
Breathable Mesh Back and Black Bonded Leather Seat	630.00



★ **25004** Breathable Mesh Back and Mesh Seat Manager's Chair with Headrest, Adjustable Arms, Adjustable Lumbar and Gunmetal Finish Base
 Overall Size: 27W x 27D x 55H
 Seat: 21.5W x 21D x 4.5T Back: 21W x 24H x 2.5T Seat Range: 19.75-22.5
 Arms to Floor: 25.5 Carton Wt: 61 UPS Wt: 61 COM: N/A
 Carton: 37L x 26W x 13H Cube: 7.23
 Options: CG50, SW70 Features: 1, 4, 6, 7, 8, 9 Control: 2-to-1 Synchro Knee Tilt
 Notes:

Fabric	List Price
Breathable Mesh Back and Black Mesh Seat	875.00



★ **2787** Professional Breathable Mesh Seat and Back Manager's Chair with Adjustable Arms, Adjustable Lumbar and Gunmetal Finish Base
 Overall Size: 28.5W x 26.25D x 44.75H
 Seat: 21.5W x 20D x 3.75T Back: 20.75W x 24.5H Seat Range: 18.25-21
 Arms to Floor: 27 Carton Wt: 58 UPS Wt: 59 COM: N/A
 Carton: 32L x 27W x 14H Cube: 7.0
 Options: CG50, SW70 Features: 1, 4, 6, 7, 8, 9 Control: 2-to-1 Synchro Knee Tilt
 Notes:

Fabric	List Price
Breathable Mesh Seat and Back with Black Leather Trim	995.00



★ **27008** Breathable Mesh Back and Leather Seat Manager's Chair with Headrest, Adjustable Arms, Adjustable Lumbar and Gunmetal Finish
 Overall Size: 27W x 27D x 55H
 Seat: 21.5W x 21D x 4.5T Back: 21W x 24H Seat Range: 19.75-22.5
 Arms to Floor: 25.5 Carton Wt: 61 UPS Wt: 61 COM: N/A
 Carton: 37L x 26W x 13H Cube: 7.23
 Options: CG50, SW70 Features: 1, 4, 6, 7, 8, 9 Control: 2-to-1 Synchro Knee Tilt
 Notes:

Fabric	List Price
Breathable Mesh Back and Black Leather Seat with Black Leather Trim	995.00



★ **27876** Professional Breathable Mesh Seat and Back Executive Chair with Adjustable Headrest, Adjustable Arms, Adjustable Lumbar and Gunmetal Finish Base
 Overall Size: 28.5W x 26.25D x 53.75H
 Seat: 21.5W x 20D x 3.75T Back: 20.7W x 34H Seat Range: 18.25-21
 Arms to Floor: 27 Carton Wt: 61 UPS Wt: 61 COM: N/A
 Carton: 37L x 26W x 13H Cube: 7.23
 Options: CG50, SW70 Features: 1, 4, 6, 7, 8, 9 Control: 2-to-1 Synchro Knee Tilt
 Notes:

Fabric	List Price
Breathable Mesh Seat and Back with Black Leather Trim	1095.00



★ **32-E3371F3** Bonded Leather Seat and Back Manager's Chair with 4-Way Adjustable Flip Arms and Gunmetal Finish Base
 ⚙️
 🌿 **Overall Size:** 27.25W x 27.25D x 45.5H
Seat: 20.5W x 19D x 3.5T **Back:** 20.5W x 23.25H x 1.5T **Seat Range:** 19 -23.25
Arms to Floor: 26.25 **Carton Wt:** 53 **UPS Wt:** 57 **COM:** N/A
Carton: 32L x 27W x 14H **Cube:** 6.74
Options: CG50, SW70 **Features:** 1, 4, 7, 8, 9 **Control:** 2-to-1 Synchro Tilt
Notes: REPLACES 2900

Fabric	List Price
Black Bonded Leather Seat and Back	600.00



★ **32-E3371F3HL** Bonded Leather Seat and Back Executive Chair with Adjustable Headrest, 4-Way Adjustable Flip Arms and Gunmetal Finish Base
 ⚙️
 🌿 **Overall Size:** 27.25W x 27.25D x 56H
Seat: 20.5W x 19D x 3.5T **Back:** 20.5W x 23.25H x 1.5T **Seat Range:** 18.5-22.75
Arms to Floor: 26.25 **Carton Wt:** 53 **UPS Wt:** 62 **COM:** N/A
Carton: 37L x 27W x 14H **Cube:** 8.09
Options: CG50, SW70 **Features:** 1, 4, 7, 8, 9 **Control:** 2-to-1 Synchro Tilt
Notes: REPLACES 29008

Fabric	List Price
Black Bonded Leather Seat and Back	700.00



⚙️ **32-E33P918P** Black Bonded Leather Seat and Back Manager's Chair with Adjustable Arms and Polished Aluminum Finish Base
 🌿 **Overall Size:** 27.75W x 29D x 45.75H
Seat: 19.5W x 20D x 4T **Back:** 21W x 22H x 2.5T **Seat Range:** 17.75-22.25
Arms to Floor: 24.5 **Carton Wt:** 55 **UPS Wt:** 55 **COM:** N/A
Carton: 31L x 26W x 13H **Cube:** 6.06
Options: SW392 **Features:** 1, 4, 7, 8, 9 **Control:** 2-to-1 Synchro Tilt
Notes: REPLACES 32-44P918P

Fabric	List Price
Black Bonded Leather Seat and Back	625.00



⚙️ **32-E33P918PHL** Black Bonded Leather Seat and Back Executive Chair with Adjustable Headrest, Adjustable Arms and Polished Aluminum Finish Base
 🌿 **Overall Size:** 27.75W x 29D x 56H
Seat: 19.5W x 20D x 4T **Back:** 21W x 22H **Seat Range:** 17.75-22.25
Arms to Floor: 25 **Carton Wt:** 59 **UPS Wt:** 59 **COM:** N/A
Carton: 31L x 26W x 14H **Cube:** 6.53
Options: SW392 **Features:** 1, 4, 7, 8, 9 **Control:** 2-to-1 Synchro Tilt
Notes: REPLACES 32-44P918PHL

Fabric	List Price
Black Bonded Leather Seat and Back	725.00



⚙️ **32-E33P91A7** Black Bonded Leather Seat and Back Manager's Chair with Polished Padded Aluminum Arms and Base
Overall Size: 26W x 27.75D x 46H
Seat: 20.5W x 19.5D x 3.75T **Back:** 21.75W x 22H x 2.5T **Seat Range:** 18.5-23
Arms to Floor: 26.25 **Carton Wt:** 44 **UPS Wt:** 59 **COM:** N/A
Carton: 32L x 27W x 14H **Cube:** 7.0
Options: SW392 **Features:** 1, 4, 7, 8, 9 **Control:** 2-to-1 Synchro Tilt
Notes:

Fabric	List Price
Black Bonded Leather Seat and Back	750.00



⚙️ **32-E33P91A7HL** Black Bonded Leather Seat and Back Manager's Chair with Adjustable Headrest, Polished Padded Aluminum Arms and Base
Overall Size: 26W x 30.5D x 56H
Seat: 20.5W x 19.5D x 3.75T **Back:** 21.75W x 22H x 2.5T **Seat Range:** 18.5-23
Arms to Floor: 26.25 **Carton Wt:** 50 **UPS Wt:** 70 **COM:** N/A
Carton: 32L x 27W x 14H **Cube:** 7
Options: SW392 **Features:** 1, 4, 7, 8, 9 **Control:** 2-to-1 Synchro Tilt
Notes:

Fabric	List Price
Black Bonded Leather Seat and Back	850.00



★ **3680** Light Air Grid® Manager's Chair with Black Top Grain Leather Seat, Adjustable Lumbar and Platinum Finish Base
 ⚙️
 🌿
Overall Size: 27.5W x 27D x 44H
Seat: 20W x 20D x 4T **Back:** 21W x 22H **Seat Range:** 18-22.5
Arms to Floor: 26 **Carton Wt:** 48 **UPS Wt:** 53 **COM:** N/A
Carton: 32L x 26W x 13H **Cube:** 6.25
Options: CG50, SW70 **Features:** 1, 4, 7, 8, 9 **Control:** 2-to-1 Synchro Tilt
Notes:

Fabric	List Price
Light Air Grid® Back and Black Top Grain Leather Seat and Trim	850.00



★ **3685** Light Air Grid® Visitor's Chair with Black Top Grain Leather Seat, Adjustable Lumbar, and Platinum Finish Sled Base
 ⚙️
 🌿
Overall Size: 27.5W x 27D x 40.25H
Seat: 20W x 20D x 4T **Back:** 21W x 22H **Seat Range:** 18.75
Arms to Floor: 27 **Carton Wt:** 52 **UPS Wt:** 56 **COM:** N/A
Carton: 31L x 23W x 16H **Cube:** 6.60
Options: N/A **Features:** N/A **Control:** N/A
Notes:

Fabric	List Price
Light Air Grid® Back and Black Top Grain Leather Seat and Trim	615.00



★ **36806** Light Air Grid® Back Executive Chair with Black Top Grain Leather Seat, Adjustable Headrest, Adjustable Lumbar and Platinum Finish Base
 ⚙️
 🌿
Overall Size: 27.5W x 27D x 54.5H
Seat: 20W x 20D x 4T **Back:** 21W x 22H **Seat Range:** 18-22.5
Arms to Floor: 26 **Carton Wt:** 58 **UPS Wt:** 67 **COM:** N/A
Carton: 38L x 26W x 13H **Cube:** 7.43
Options: CG50, SW70 **Features:** 1, 4, 7, 8, 9 **Control:** 2-to-1 Synchro Tilt
Notes:

Fabric	List Price
Light Air Grid® Back and Black Top Grain Leather Seat and Trim	950.00



★ **327-E36C61F6** Light Air Grid® Back Chair with Padded Bonded Leather Seat, 4-Way Adjustable Flip Arms, Optional Headrest and Platinum Coated Nylon Base
 ⚙️
 🌿
Overall Size: 27.5W x 26.5D x 44.75H
Seat: 20.5W x 19D x 3.5T **Back:** 20W x 22.5H **Seat Range:** 19 - 23
Arms to Floor: 26.25 **Carton Wt:** 45 **UPS Wt:** 53 **COM:** N/A
Carton: 32L x 26W x 13H **Cube:** 6.25
Options: CG50, SW70 **Features:** 1, 4, 7, 8, 9 **Control:** 2-to-1 Synchro Tilt
Notes: Optional Headrest EHRL006

Fabric	List Price
Light Air Grid® Back and Black Bonded Leather Seat	695.00



★ **327-66C61F6** Light Air Grid® Seat and Back Chair with 4-Way Adjustable Flip Arms, Optional Headrest and Platinum Coated Nylon Base
 ⚙️
 🌿
Overall Size: 29.25W x 27.5D x 40.75-45H
Seat: 21.5W x 20D **Back:** 20.5W x 22.5H **Seat Range:** 18.25 - 22.5
Arms to Floor: 28.5 **Carton Wt:** 47 **UPS Wt:** 53 **COM:** N/A
Carton: 32L x 26W x 13H **Cube:** 6.25
Options: CG50, SW70 **Features:** 1, 4, 7, 8, 9 **Control:** 2-to-1 Synchro Tilt
Notes: Optional Headrest EHRL006

Fabric	List Price
Light Air Grid® Seat and Back	765.00



⚙️ **327-E36C61F6HL** Light Air Grid® Back Chair with Padded Bonded Leather Seat, 4-Way Adjustable Flip Arms, Adjustable Headrest and Platinum Coated Nylon Base
 🌿
Overall Size: 27.5W x 26.5D x 57H
Seat: 20.5W x 19D x 3.5T **Back:** 20W x 22.5H **Seat Range:** 19 - 23
Arms to Floor: 26.25 **Carton Wt:** 47 **UPS Wt:** 53 **COM:** N/A
Carton: 32L x 26W x 13H **Cube:** 6.25
Options: CG50, SW70 **Features:** 1, 4, 7, 8, 9 **Control:** 2-to-1 Synchro Tilt
Notes:

Fabric	List Price
Light Air Grid® Back and Black Bonded Leather Seat	785.00



327-66C61F6HL Light Air Grid® Seat and Back Chair with 4-Way Adjustable Flip Arms, Adjustable Headrest and Platinum Coated Nylon Base

Overall Size: 27.5W x 26.5D x 57H
Seat: 20.5W x 19D **Back:** 20W x 22.5H **Seat Range:** 18.25 - 22.25
Arms to Floor: 26.25 **Carton Wt:** 46 **UPS Wt:** 57 **COM:** N/A
Carton: 32L x 26W x 14H **Cube:** 6.74
Options: CG50, SW70 **Features:** 1, 4, 7, 8, 9 **Control:** 2-to-1 Synchro Tilt
Notes:

Fabric	List Price
Light Air Grid® Seat and Back	855.00



37-33N1A7U Executive Black Mesh Chair with Soft PU Padded Adjustable Arms and Deluxe Nylon Base

Overall Size: 27.25W x 28D x 41.25-45.5H
Seat: 21W x 18.5D x 4T **Back:** 21W x 23.25H x 2.5T **Seat Range:** 18 - 22.25
Arms to Floor: 26 **Carton Wt:** 48 **UPS Wt:** 57 **COM:** N/A
Carton: 32L x 26W x 14H **Cube:** 6.74
Options: CG50, SW70 **Features:** 1, 4, 7, 8, 9 **Control:** 2-to-1 Synchro Tilt
Notes:

Fabric	List Price
Black Mesh Seat and Back	550.00



55-7N17 Professional Air Grid® Back Manager's Chair with Custom Fabric Seat, Adjustable Arms and Angled Nylon Base

Overall Size: 27W x 26.5D x 42H
Seat: 20.5W x 19.5D x 3.5T **Back:** 20.5W x 19H **Seat Range:** 18.75-23
Arms to Floor: 25.5 **Carton Wt:** 40 **UPS Wt:** 46 **COM:** 1 yd
Carton: 28L x 26W x 13H **Cube:** 5.47
Options: SW392 **Features:** 1, 4, 7, 8, 9 **Control:** 2-to-1 Synchro Tilt
Notes:



Fabric	List Price
Air Grid® Back and Custom Fabric Seat	
A	395.00
B	410.00
C	430.00
R	460.00



55-7V30 Professional Air Grid® Back Visitor's Chair with Custom Fabric Seat, Fixed Arms and Sled Base

Overall Size: 25.75W x 26.5D x 37.25H
Seat: 20.75W x 19.25D x 4T **Back:** 20W x 19.25H **Seat Range:** 19
Arms to Floor: 26.25 **Carton Wt:** 36 **UPS Wt:** 51 **COM:** 1 yd
Carton: 27L x 24W x 16H **Cube:** 6.0
Options: N/A **Features:** N/A **Control:** N/A
Notes:



Fabric	List Price
Air Grid® Back and Custom Fabric Seat	
A	360.00
B	375.00
C	395.00
R	425.00



55-38N17 Latte Air Grid® Back Deluxe Task Chair with Black Mesh Seat, Adjustable Angled Arms and Angled Nylon Base

Overall Size: 27W x 26.5D x 42H
Seat: 20.5W x 19.5D x 3.5T **Back:** 20.5W x 19H **Seat Range:** 18.75-23
Arms to Floor: 25.5 **Carton Wt:** 40 **UPS Wt:** 46 **COM:** N/A
Carton: 28L x 26W x 13H **Cube:** 5.47
Options: SW392 **Features:** 1, 4, 7, 8, 9 **Control:** 2-to-1 Synchro Tilt
Notes:

Fabric	List Price
Latte Air Grid® Back and Black Mesh Seat	375.00



55-88N15 Latte Air Grid® Seat and Back Deluxe Task Chair with Adjustable Angled Arms and Angled Nylon Base

Overall Size: 27W x 26.5D x 42H
Seat: 20.5W x 19.5D **Back:** 20.5W x 18.5H **Seat Range:** 18-22.25
Arms to Floor: 25.5 **Carton Wt:** 40 **UPS Wt:** 46 **COM:** N/A
Carton: 28L x 26W x 13H **Cube:** 5.47
Options: SW392 **Features:** 1, 4, 7, 8, 9 **Control:** 2-to-1 Synchro Tilt
Notes:

Fabric	List Price
Latte Air Grid® Seat and Back	440.00



★ **55-M22N17** Shadow Air Grid® Back and Shadow Mesh Seat, Adjustable Angled Arms and Angled Nylon Base
 ⚙️
 🌿
Overall Size: 27W x 26.5D x 42H
Seat: 20.5W x 19.5D x 3.5T **Back:** 20.5W x 18.5H **Seat Range:** 18.75-23
Arms to Floor: 25.5 **Carton Wt:** 40 **UPS Wt:** 46 **COM:** N/A
Carton: 28L x 26W x 13H **Cube:** 5.47
Options: SW392 **Features:** 1, 4, 7, 8, 9 **Control:** 2-to-1 Synchro Tilt
Notes:

Fabric	List Price
Shadow Air Grid® Back and Shadow Mesh Seat	375.00





★ **5500®** Air Grid® Back and Black Mesh Seat, Adjustable Angled Arms and Angled Nylon Base
 ⚙️
 🌿
Overall Size: 26.5W x 25.25D x 42H
Seat: 20.5W x 19.5D x 3.5T **Back:** 20.5W x 18.5H **Seat Range:** 18.75-23
Arms to Floor: 25.5 **Carton Wt:** 38 **UPS Wt:** 48 **COM:** 1 yd.
Carton: 27L x 26W x 14H **Cube:** 5.68
Options: SW392 **Features:** 1, 4, 7, 8, 9 **Control:** 2-to-1 Synchro Tilt
Notes: Available in Fun Colors - see page 24.

Fabric	List Price
Air Grid® Back & Black Mesh Seat	375.00
 (Seat only)	395.00



★ **5500SL** Air Grid® Back and Black Mesh Seat, Adjustable Angled Arms, Seat Slider and Angled Nylon Base
 ⚙️
 🌿
Overall Size: 26.75W x 24.75D x 41.75H
Seat: 20.5W x 19.5D x 3.5T **Back:** 20.5W x 18.5H **Seat Range:** 18.75-23.25
Arms to Floor: 25.75 **Carton Wt:** 47 **UPS Wt:** 55 **COM:** 1 yd.
Carton: 32L x 27W x 13H **Cube:** 6.5
Options: SW392 **Features:** 1, 4, 7, 8, 9, 15 **Control:** 2-to-1 Synchro Tilt
Notes: 3-Position Lock with Anti-Kick Control. Available in Fun Colors - see page 24.

Fabric	List Price
Air Grid® Back & Black Mesh Seat	450.00
 (Seat only)	475.00
 PROGRAM	
A	475.00
B	500.00
C	525.00
R	570.00

NEW
 Featuring New Seat Slider



(Seat Only)

Shown: 5500®



★ **5500V** Black Vinyl Over Air Grid® Back and Black Vinyl Seat, Adjustable Angled Arms and Angled Nylon Base
 ⚙️ **Overall Size:** 26.5W x 25.25D x 42H
 🌿 **Seat:** 20.5W x 19.5D x 3.5T **Back:** 20.5W x 18.5H **Seat Range:** 18.75-23
Arms to Floor: 25.5 **Carton Wt:** 40 **UPS Wt:** 46 **COM:** N/A
Carton: 28L x 26W x 13H **Cube:** 5.47
Options: SW392 **Features:** 1, 4, 7, 8, 9 **Control:** 2-to-1 Synchro Tilt
Notes:

Fabric	List Price
Black Vinyl Over Air Grid® Back and Black Vinyl Seat	375.00



★ **5505** Professional Air Grid® Back Visitor's Chair with Black Mesh Seat, Fixed Arms and Sled Base
 ⚙️ **Overall Size:** 24.5W x 25.5D x 37.25H
 🌿 **Seat:** 20.5W x 19.5D x 3T **Back:** 20.5W x 18.5H **Seat Range:** 19 Fixed
Arms to Floor: 25.5 **Carton Wt:** 40 **UPS Wt:** 51 **COM:** 1 yd.
Carton: 27L x 24W x 16H **Cube:** 6.0
Options: N/A **Features:** N/A **Control:** N/A
Notes: Available in Fun Colors - see page 24.

Fabric	List Price
Air Grid® Back & Black Mesh Seat	340.00
 (Seat only)	360.00



⚙️ **55-38V30** Professional Latte Air Grid® Back Visitor's Chair with Black Mesh Seat, Fixed Arms and Sled Base
 🌿 **Overall Size:** 26W x 26D x 37.25H
Seat: 20.75W x 19.75D x 3.75T **Back:** 20.5W x 19H **Seat Range:** 20 Fixed
Arms to Floor: 26 **Carton Wt:** 38 **UPS Wt:** 50 **COM:** N/A
Carton: 26L x 23W x 17H **Cube:** 5.88
Options: N/A **Features:** N/A **Control:** N/A
Notes:

Fabric	List Price
Latte Air Grid® Back and Black Mesh Seat	340.00



★ **5540** Air Grid® Back and Mesh Seat Manager's Chair with Adjustable Angled Arms, Adjustable Lumbar and Angled Nylon Base
 ⚙️ **Overall Size:** 27.5W x 28.5D x 46H
 🌿 **Seat:** 21.75W x 19.5D x 4.25T **Back:** 20.5W x 32.75H **Seat Range:** 19-23.25
Arms to Floor: 25.5 **Carton Wt:** 43 **UPS Wt:** 61 **COM:** N/A
Carton: 37L x 26W x 13H **Cube:** 7.23
Options: HRM003, SW392 **Features:** 1, 4, 7, 8, 9 **Control:** 2-to-1 Synchro Tilt
Notes:

Fabric	List Price
Air Grid® Back and Black Mesh Seat and Trim	500.00



★ **5560** Air Grid® Seat and Back Manager's Chair with Adjustable Angled Arms and Angled Nylon Base
 ⚙️ **Overall Size:** 26.75W x 26.5D x 42H
 🌿 **Seat:** 20.5W x 21D **Back:** 20.5W x 18.5H **Seat Range:** 18-22.25
Arms to Floor: 25.5 **Carton Wt:** 42 **UPS Wt:** 46 **COM:** N/A
Carton: 28L x 26W x 13H **Cube:** 5.47
Options: SW392 **Features:** 1, 4, 7, 8, 9 **Control:** 2-to-1 Synchro Tilt
Notes:

Fabric	List Price
Air Grid® Seat and Back	440.00



-261 Pink



-7 Blue



-512 Purple



-9 Red

55 and 57 Series



★ **5565** Air Grid® Seat and Back Visitor's Chair with Adjustable Angled Arms and Sled Base
 ⚙️
 🌿
Overall Size: 26.5W x 27D x 37.25H
Seat: 20.5W x 21D **Back:** 20.5W x 18.5H **Seat Range:** 18.25
Arms to Floor: 26 **Carton Wt:** 40 **UPS Wt:** 55 **COM:** N/A
Carton: 28L x 24W x 16H **Cube:** 6.22
Options: N/A **Features:** N/A **Control:** N/A
Notes:

Fabric	List Price
Air Grid® Seat and Back	390.00



★ **55403** Air Grid® Back and Mesh Seat Manager's Chair with Adjustable Headrest, Adjustable Angled Arms, Adjustable Lumbar and Angled Nylon Base
 ⚙️
 🌿
Overall Size: 27W x 27.5D x 47.75 - 56H
Seat: 21.75W x 19D x 4.25T **Back:** 20.5W x 29.75H **Seat Range:** 18.75 - 23
Arms to Floor: 25 **Carton Wt:** 47 **UPS Wt:** 61 **COM:** N/A
Carton: 37L x 26W x 13H **Cube:** 7.23
Options: SW392 **Features:** 1, 4, 7, 8, 9 **Control:** 2-to-1 Synchro Tilt
Notes:

Fabric	List Price
Air Grid® Back and Black Mesh Seat and Trim	595.00

57 Series



★ **5700E®** Air Grid® Back and Black Bonded Leather Seat Manager's Chair with Adjustable Angled Arms and Angled Nylon Base
 ⚙️
 🌿
Overall Size: 26.5W x 25.25D x 42H
Seat: 20.5W x 19.5D x 3.5T **Back:** 20.5W x 18.5H **Seat Range:** 18.75-23
Arms to Floor: 25.5 **Carton Wt:** 41 **UPS Wt:** 45 **COM:** N/A
Carton: 27L x 26W x 13H **Cube:** 5.28
Options: SW392 **Features:** 1, 4, 7, 8, 9 **Control:** 2-to-1 Synchro Tilt
Notes: REPLACES 5700®

Fabric	List Price
Air Grid® Back and Black Bonded Leather Seat	385.00



★ **5700SL** Air Grid® Back and Black Bonded Leather Seat Manager's Chair with Adjustable Angled Arms, Seat Slider and Angled Nylon Base
 ⚙️
Overall Size: 26.75W x 24.75D x 41.75H
Seat: 20.5W x 19.5D x 3.5T **Back:** 20.5W x 18.5H **Seat Range:** 18.75-23.25
Arms to Floor: 25.75 **Carton Wt:** 47 **UPS Wt:** 53 **COM:** N/A
Carton: 31L x 27W x 13H **Cube:** 6.29
Options: SW392 **Features:** 1, 4, 7, 8, 9, 15 **Control:** 2-to-1 Synchro Tilt
Notes: 3-Position Lock with Anti-Kick Control.

NEW

Featuring New Seat Slider

Fabric	List Price
Air Grid® Back and Black Bonded Leather Seat	465.00



★ **5705E** Professional Air Grid® Back Visitor's Chair with Bonded Leather Seat, Fixed Arms and Sled Base
 ⚙️
 🌿
Overall Size: 24.5W x 25.5D x 37.25H
Seat: 20.5W x 19.5D x 3T **Back:** 20.5W x 18.5H **Seat Range:** 19
Arms to Floor: 25.75 **Carton Wt:** 38 **UPS Wt:** 47 **COM:** N/A
Carton: 26L x 23W x 16H **Cube:** 5.53
Options: N/A **Features:** N/A **Control:** N/A
Notes: REPLACES 5705

Fabric	List Price
Air Grid® Back and Black Bonded Leather Seat	350.00



★ **5790E** Dark Air Grid® Back and Bonded Leather Seat Manager's Chair with Adjustable Angled Arms, Adjustable Lumbar and Angled Nylon Base
 ⚙️
 🌿
Overall Size: 27.5W x 28.5D x 46H
Seat: 21.75W x 19.5D x 4.25T **Back:** 20.5W x 32.75H **Seat Range:** 19-23.25
Arms to Floor: 25.5 **Carton Wt:** 44 **UPS Wt:** 53 **COM:** N/A
Carton: 32L x 26W x 13H **Cube:** 7.23
Options: SW392 **Features:** 1, 4, 7, 8, 9 **Control:** 2-to-1 Synchro Tilt
Notes:

Fabric	List Price
Air Grid® Back and Black Bonded Leather Seat	570.00



★ **57906E** Air Grid® Back and Bonded Leather Seat Manager's Chair with Adjustable Headrest, Adjustable Angled Arms, Adjustable Lumbar and Angled Nylon Base

⚙️ **Overall Size:** 27.5W x 28.5D x 56.25H
Seat: 21.75W x 19.5D x 4.25T **Back:** 20.5W x 32.75H **Seat Range:** 19-23.25
Arms to Floor: 25.5 **Carton Wt:** 47 **UPS Wt:** 63 **COM:** N/A
Carton: 38L x 26W x 13H **Cube:** 7.43
Options: SW392 **Features:** 1, 4, 7, 8, 9 **Control:** 2-to-1 Synchro Tilt
Notes: REPLACES 57906

Fabric	List Price
Air Grid® Back & Black Bonded Leather Seat & Trim	670.00



★ **2160SL** Dark Air Grid® Seat and Back with PU Padded Adjustable Arms, Built-In Lumbar Support and Nylon Base

⚙️ **Overall Size:** 27.5W x 23.75D x 42.5H
Seat: 20W x 19.5D x 2.5T **Back:** 21W x 21.25H **Seat Range:** 18.25-22.25
Arms to Floor: 25.75 **Carton Wt:** 48 **UPS Wt:** 53 **COM:** N/A
Carton: 32L x 26W x 13H **Cube:** 6.25
Options: SW392 **Features:** 1, 4, 7, 8, 9, 15 **Control:** 2-to-1 Synchro Tilt
Notes: 3-Position Lock with Anti-Kick Control.

NEW
Seat Slider

Fabric	List Price
Air Grid® Seat and Back	550.00



★ **213-38N1F3** Latte Air Grid® Back and Padded Mesh Seat Chair with 4-Way Adjustable Flip Arms, 2-to-1 Synchro Tilt, Adjustable Tilt Tension and Nylon Base

⚙️ **Overall Size:** 26.5W x 25.25D x 43.5H
Seat: 20.5W x 19.25D x 3.5T **Back:** 21.25W x 21.25H **Seat Range:** 18.75 - 23
Arms to Floor: 25.5 **Carton Wt:** 42 **UPS Wt:** 45 **COM:** N/A
Carton: 27L x 26W x 13H **Cube:** 5.28 **Options:** SW392
Features: 1, 4, 7, 8, 9 **Control:** 2-to-1 Synchro Tilt
Notes: REPLACES 18-28N28P

Fabric	List Price
Latte Air Grid® Back and Padded Black Mesh Seat	470.00



⚙️ **213-88N1F3** Latte Air Grid® Seat and Back Chair with 4-Way Adjustable Flip Arms, Built-In Lumbar Support, 2-to-1 Synchro Tilt, Adjustable Tilt Tension and Nylon Base

⚙️ **Overall Size:** 27.25W x 25D x 43.5H
Seat: 21.5W x 19.5D **Back:** 21.25W x 20.75H **Seat Range:** 18.5-22.75
Arms to Floor: 26.5 **Carton Wt:** 42 **UPS Wt:** 45 **COM:** N/A
Carton: 28L x 26W x 13H **Cube:** 5.28 **Options:** SW392
Features: 1, 4, 7, 8, 9 **Control:** 2-to-1 Synchro Tilt
Notes: REPLACES 18-88N28P

Fabric	List Price
Latte Air Grid® Seat and Back	550.00



⚙️ **213-E37P91F3** Air Grid® Back and Padded Bonded Leather Seat with 4-Way Adjustable Flip Arms, Built-In Lumbar Support and Polished Aluminum Base

⚙️ **Overall Size:** 27.5W x 23.75D x 42.5H
Seat: 20W x 19.5D x 2.5T **Back:** 21W x 21.25H **Seat Range:** 18.25-22.25
Arms to Floor: 25.75 **Carton Wt:** 48 **UPS Wt:** 48 **COM:** N/A
Carton: 29L x 26W x 13H **Cube:** 5.67
Options: SW392 **Features:** 1, 4, 7, 8, 9 **Control:** 2-to-1 Synchro Tilt
Notes: REPLACES 58-47P918P

Fabric	List Price
Air Grid® Back and Padded Bonded Leather Seat	550.00



★ **213-37P91A7** Air Grid® Back and Padded Mesh Seat with Padded Polished Aluminum Arms, Built-In Lumbar Support and Polished Aluminum Base

⚙️ **Overall Size:** 26W x 27D x 42.5H
Seat: 20.5W x 19.5D x 3.5T **Back:** 21.25W x 20.75H **Seat Range:** 18.5-23
Arms to Floor: 26.25 **Carton Wt:** 41 **UPS Wt:** 50 **COM:** 1 yd.
Carton: 29L x 27W x 13H **Cube:** 5.89
Options: SW392 **Features:** 1, 4, 7, 8, 9 **Control:** 2-to-1 Synchro Tilt
Notes: Available in Fun Colors - see page 24.

Fabric	List Price
Air Grid® Back and Padded Mesh Seat	575.00
 (Seat only)	600.00



⚙️ **213-E37P91A7** Air Grid[®] Back and Padded Bonded Leather Seat with Padded Polished Aluminum Arms, Built-In Lumbar Support and Polished Aluminum Base
Overall Size: 26W x 27D x 42.5H
Seat: 20.5W x 19.5D x 3.5T **Back:** 21.25W x 20.75H **Seat Range:** 18.5-23
Arms to Floor: 26.25 **Carton Wt:** 40 **UPS Wt:** 48 **COM:** N/A
Carton: 29L x 26W x 13H **Cube:** 5.67
Options: SW392 **Features:** 1, 4, 7, 8, 9 **Control:** 2-to-1 Synchro Tilt
Notes:

Fabric	List Price
Air Grid [®] Back and Padded Bonded Leather Seat	585.00



⚙️ **213-J11N1W** Latte Fabric Padded Seat and Back with Height Adjustable PU Padded Arms, Built-In Lumbar Support and Angled Nylon Base
Overall Size: 27.75W x 27.25D x 42.75H
Seat: 20.5W x 19.5D x 3.5T **Back:** 21.25W x 20.75H **Seat Range:** 18.5-23
Arms to Floor: 25.5 **Carton Wt:** 39 **UPS Wt:** 46 **COM:** N/A
Carton: 28L x 26W x 13H **Cube:** 5.47
Options: SW392 **Features:** 1, 4, 7, 8, 9 **Control:** 2-to-1 Synchro Tilt
Notes:

Fabric	List Price
Latte Fabric Seat and Back	440.00



⚙️ **213-J44N1W** Teal Fabric Padded Seat and Back with Height Adjustable PU Padded Arms, Built-In Lumbar Support and Angled Nylon Base
Overall Size: 27.75W x 27.25D x 42.75H
Seat: 20.5W x 19.5D x 3.5T **Back:** 21.25W x 20.75H **Seat Range:** 18.5-23
Arms to Floor: 25.5 **Carton Wt:** 39 **UPS Wt:** 46 **COM:** N/A
Carton: 28L x 26W x 13H **Cube:** 5.47
Options: SW392 **Features:** 1, 4, 7, 8, 9 **Control:** 2-to-1 Synchro Tilt
Notes:

Fabric	List Price
Teal Fabric Seat and Back	440.00



⚙️ **213-J77N1W** Sand Fabric Padded Seat and Back with Height Adjustable PU Padded Arms, Built-In Lumbar Support and Angled Nylon Base
Overall Size: 27.75W x 27.25D x 42.75H
Seat: 20.5W x 19.5D x 3.5T **Back:** 21.25W x 20.75H **Seat Range:** 18.5-23
Arms to Floor: 25.5 **Carton Wt:** 39 **UPS Wt:** 46 **COM:** N/A
Carton: 28L x 26W x 13H **Cube:** 5.47
Options: SW392 **Features:** 1, 4, 7, 8, 9 **Control:** 2-to-1 Synchro Tilt
Notes:

Fabric	List Price
Sand Fabric Seat and Back	440.00



⚙️ **213-J88N1W** Salmon Fabric Padded Seat and Back with Height Adjustable PU Padded Arms, Built-In Lumbar Support and Angled Nylon Base
Overall Size: 27.75W x 27.25D x 42.75H
Seat: 20.5W x 19.5D x 3.5T **Back:** 21.25W x 20.75H **Seat Range:** 18.5-23
Arms to Floor: 25.5 **Carton Wt:** 39 **UPS Wt:** 46 **COM:** N/A
Carton: 28L x 27W x 13H **Cube:** 5.47
Options: SW392 **Features:** 1, 4, 7, 8, 9 **Control:** 2-to-1 Synchro Tilt
Notes:

Fabric	List Price
Salmon Fabric Seat and Back	440.00



⚙️ **213-J99N1W** Steel Fabric Padded Seat and Back with Height Adjustable PU Padded Arms, Built-In Lumbar Support and Angled Nylon Base
Overall Size: 27.75W x 27.25D x 42.75H
Seat: 20.5W x 19.5D x 3.5T **Back:** 21.25W x 20.75H **Seat Range:** 18.5-23
Arms to Floor: 25.5 **Carton Wt:** 39 **UPS Wt:** 46 **COM:** N/A
Carton: 28L x 26W x 13H **Cube:** 5.47
Options: SW392 **Features:** 1, 4, 7, 8, 9 **Control:** 2-to-1 Synchro Tilt
Notes:

Fabric	List Price
Steel Fabric Seat and Back	440.00



⚙️ **6216** Deluxe Air Grid® Back and Seat Manager's Chair with Adjustable Arms, Adjustable Lumbar and Gunmetal Finish Base

Overall Size: 28.5W x 27D x 44.5H
Seat: 21.75W x 20.5D **Back:** 21.5W x 24H **Seat Range:** 17.75-22
Arms to Floor: 26.25 **Carton Wt:** 51 **UPS Wt:** 51 **COM:** N/A
Carton: 31L x 26W x 12H **Cube:** 5.59
Options: CG50, SW70 **Features:** 1, 4, 7, 8, 9 **Control:** 2-to-1 Synchro Tilt
Notes:

Fabric	List Price
Air Grid® Seat and Back	775.00



⚙️ **6236** Deluxe Air Grid® Seat and Back Manager's Chair with Adjustable Arms, Adjustable Lumbar, Dual Function Control and Gunmetal Finish Base

Overall Size: 28.5W x 27D x 44.5H
Seat: 21.75W x 20.5D **Back:** 21.5W x 24H **Seat Range:** 18.25-22.5
Arms to Floor: 27 **Carton Wt:** 57 **UPS Wt:** 57 **COM:** N/A
Carton: 32L x 26W x 11H **Cube:** 5.29
Options: CG50, SW70 **Features:** 1, 4, 8, 9, 11 **Control:** Dual Function
Notes:

Fabric	List Price
Air Grid® Seat and Back	825.00

63 Series



★ ⚙️ **63-37A773HM** Dual Layer Air Grid® Back and Black Mesh Seat, Adjustable Headrest, 2-Way Adjustable Arms, Adjustable Lumbar and Gunmetal Finish Base

Overall Size: 28.75W x 29D x 48.5 - 55.5H
Seat: 21.5W x 21.5D x 4T **Back:** 21W x 28.25H **Seat Range:** 20 - 22.75
Arms to Floor: 26 **Carton Wt:** 69 **UPS Wt:** 69 **COM:** N/A
Carton: 37L x 26W x 13H **Cube:** 7.23 **Options:** CG50, SW70
Features: 1, 4, 6, 8, 9 **Control:** Mid Pivot Knee Tilt
Notes:

Fabric	List Price
Dual Layer Air Grid® Back and Black Mesh Seat and Trim	895.00

Big & Tall 400 lbs.



★ ⚙️ **63-E37A773HL** Dual Layer Air Grid® Back and Black Bonded Leather Seat, Adjustable Headrest, 2-Way Adjustable Arms, Adjustable Lumbar and Gunmetal Finish Base

Overall Size: 28.5W x 29D x 49 - 56H
Seat: 21.5W x 21.75D x 4.75T **Back:** 21.75W x 22H **Seat Range:** 20.75-23
Arms to Floor: 26.25 **Carton Wt:** 61 **UPS Wt:** 61 **COM:** N/A
Carton: 37L x 26W x 13H **Cube:** 7.23 **Options:** CG50, SW70
Features: 1, 4, 6, 8, 9 **Control:** Mid Pivot Knee Tilt
Notes:

Fabric	List Price
Dual Layer Air Grid® Back and Black Bonded Leather Seat and Trim	1050.00

Big & Tall 400 lbs.



★ ⚙️ **63-E3T17C63C** Black Vertical Mesh Back and Black Bonded Leather Seat, Height Adjustable Chrome Arms, Height & Depth Adjustable Lumbar Support & Polished Aluminum Base

Overall Size: 27.25W x 24.25D x 40.5-45H
Seat: 21.5W x 19.25D x 3T **Back:** 21.5W x 23.25H **Seat Range:** 17.75-22.25
Arms to Floor: 24.5 **Carton Wt:** 53 **UPS Wt:** 55 **COM:** N/A
Carton: 31L x 26W x 14H **Cube:** 6.53 **Options:** CG50, SW70
Features: 1, 3, 4, 7, 8, 9, 15 **Control:** Deluxe 2-to-1 with Seat Slider
Notes: Optional HRL818 Leather Headrest - see page 31.
 Patent#: US D534, 398 S

Fabric	List Price
Black Vertical Mesh Back and Black Bonded Leather Seat	800.00

NEW

Seat Slider



★ ⚙️ **63-T117C63C** Black Vertical Mesh Back and Seat, Height Adjustable Chrome Arms, Height & Depth Adjustable Lumbar Support and Polished Aluminum Base

Overall Size: 27.25W x 24.5D x 40.5-45H
Seat: 21.5W x 20D **Back:** 21.5W x 23.25H **Seat Range:** 17.5-22
Arms to Floor: 24.5 **Carton Wt:** 54 **UPS Wt:** 55 **COM:** N/A
Carton: 31L x 26W x 14H **Cube:** 6.53 **Options:** CG50, SW70
Features: 1, 3, 4, 7, 8, 9, 15 **Control:** Deluxe 2-to-1 with Seat Slider
Notes: Optional HRX818 Mesh Headrest - see page 31.
 Patent#: US D534, 398 S

Fabric	List Price
Black Vertical Mesh Seat and Back	895.00

NEW

Seat Slider

67 and 68 Series



⚙️ **67-66N61R5** Light Air Grid® Back and Seat Manager's Chair with Flip Arms, and Angled Platinum Finished Nylon Base
 🌿
Overall Size: 27.75W x 24.75D x 43.25H
Seat: 20W x 20D **Back:** 19W x 19.5H **Seat Range:** 19.25-23.5
Arms to Floor: 27.5 **Carton Wt:** 47 **UPS Wt:** 47 **COM:** N/A
Carton: 28L x 26W x 13H **Cube:** 5.47
Options: SW392 **Features:** 1, 4, 7, 8, 9 **Control:** 2-to-1 Synchro Tilt
Notes: REPLACES 67-66N69R5 Patent#: US D534, 384 S

NEW

Fabric	List Price
Light Air Grid® Back and Seat	550.00



⚙️ **67-77N1G5** Dark Air Grid® Back and Seat Manager's Chair with Flip Arms, and Angled Nylon Base
 🌿
Overall Size: 27.25W x 25.55D x 43H
Seat: 20W x 20D **Back:** 19W x 19.5H **Seat Range:** 19.25-23.5
Arms to Floor: 27.5 **Carton Wt:** 47 **UPS Wt:** 47 **COM:** N/A
Carton: 28L x 26W x 13H **Cube:** 5.47
Options: SW392 **Features:** 1, 4, 7, 8, 9 **Control:** 2-to-1 Synchro Tilt
Notes: REPLACES 67-77N9G5 Patent#: US D534, 384 S

NEW

Fabric	List Price
Air Grid® Back and Seat	550.00



★ ⚙️ **67-E36N61R5** Light Air Grid® Back and Black Bonded Leather Seat Manager's Chair with 2-to-1 Synchro Tilt, Flip Arms and Angled Platinum Finished Nylon Base
 🌿
Overall Size: 27.75W x 24D x 42.5H
Seat: 20.5W x 19D x 3.5T **Back:** 19W x 20.75H **Seat Range:** 18.75-23
Arms to Floor: 27.25 **Carton Wt:** 41 **UPS Wt:** 46 **COM:** N/A
Carton: 28L x 26W x 13H **Cube:** 5.47
Options: SW392 **Features:** 1, 4, 7, 8, 9 **Control:** 2-to-1 Synchro Tilt
Notes:

Fabric	List Price
Light Air Grid® Back and Black Bonded Leather Seat	490.00



★ ⚙️ **67-37N1G5** Dark Air Grid® Back and Mesh Seat Manager's Chair with 2-to-1 Synchro Tilt, Flip Arms and Angled Nylon Base
 🌿
Overall Size: 28W x 25D x 42.5H
Seat: 20.5W x 19D x 4T **Back:** 19W x 20.75H **Seat Range:** 18.75-23
Arms to Floor: 27 **Carton Wt:** 42 **UPS Wt:** 46 **COM:** 0.75 yd.
Carton: 28L x 26W x 13H **Cube:** 5.47
Options: SW392 **Features:** 1, 4, 7, 8, 9 **Control:** 2-to-1 Synchro Tilt
Notes:



Fabric	List Price
Air Grid® Back and Mesh Seat	490.00
A	515.00
B	540.00
C	565.00
R	590.00

68 Series



★ ⚙️ **68-50764** Breathable Mesh Back and Layered Leather Seat, 4-Way Adjustable Arms, Seat Slider, Dual-Function Control and Gunmetal Finish Base
 🌿
Overall Size: 28W x 27D x 41H
Seat: 21.5W x 21D x 4.5T **Back:** 21.5W x 22H **Seat Range:** 18-21.25
Arms to Floor: 25.25 **Carton Wt:** 60 **UPS Wt:** 61 **COM:** N/A
Carton: 32L x 26W x 15H **Cube:** 7.22 **Options:** CG50, SW70
Features: 1, 2, 3, 4, 8, 11, 15 **Control:** Dual-Function with Seat Slider
Notes:

Seat Slider

Fabric	List Price
Breathable Mesh Back and Layered Black Leather Seat	950.00



⚙️ **6806** Professional Dual Function Air Grid® Back and Black Mesh Seat Manager's Chair with Adjustable Arms, Adjustable Lumbar and Gunmetal Finish Base
 🌿
Overall Size: 28.25W x 30.25D x 44.75H
Seat: 21.5W x 21D x 4.5T **Back:** 21.5W x 24H **Seat Range:** 18.25-22.5
Arms to Floor: 27.25 **Carton Wt:** 57 **UPS Wt:** 57 **COM:** N/A
Carton: 32L x 26W x 14H **Cube:** 6.74
Options: CG50, SW70 **Features:** 1, 4, 8, 9, 11 **Control:** Dual Function
Notes:

Fabric	List Price
Air Grid® Back and Mesh Seat	800.00



⚙️ **6876** Professional Dual Function Air Grid® Back and Leather Seat Manager's Chair with Adjustable Arms, Adjustable Lumbar and Gunmetal Finish Base

Overall Size: 28.25W x 30.25D x 44.75H
Seat: 21.5W x 21D x 4.5T **Back:** 21.5W x 24H **Seat Range:** 18.25-22.5
Arms to Floor: 27.25 **Carton Wt:** 57 **UPS Wt:** 57 **COM:** N/A
Carton: 32L x 26W x 14H **Cube:** 6.74
Options: CG50, SW70 **Features:** 1, 4, 8, 9, 11 **Control:** Dual Function
Notes:

Fabric	List Price
Air Grid® Back and Leather Seat	875.00

75 Series



⚙️ **75-7A773** Dual Layer Air Grid® Back and Custom Fabric Seat Ergonomic Chair with Adjustable Lumbar, 2-Way Adjustable Arms and Gunmetal Finish Base

Overall Size: 30.25W x 28.75D x 44.5H
Seat: 22W x 21D x 4.25T **Back:** 20.75W x 22.5H **Seat Range:** 19-22
Arms to Floor: 25.5 **Carton Wt:** 62 **UPS Wt:** 63 **COM:** 1 yds
Carton: 32L x 27W x 15H **Cube:** 7.5
Options: CG50, SW70 **Features:** 1, 4, 6, 8, 9 **Control:** Mid Pivot Knee Tilt
Notes:



Fabric	List Price
Dual Layer Dark Air Grid® Back and Custom Fabric Seat	
A	900.00
B	950.00
C	985.00
R	1050.00

Big & Tall 400 lbs.



★ ⚙️ **75-37A773** Dual Layer Air Grid® Back and Black Mesh Seat Ergonomic Chair with Adjustable Lumbar, 2-Way Adjustable Arms and Gunmetal Finish Base

Overall Size: 28.5W x 26.75D x 42.5-45.25H
Seat: 21.75W x 21.75D x 4.5T **Back:** 21W x 22H **Seat Range:** 19.75-22.5
Arms to Floor: 29 **Weight:** 65 **UPS Wt:** 69 **COM:** N/A
Carton: 32L x 26W x 17H **Cube:** 8.18
Options: CG50, SW70 **Features:** 1, 4, 6, 8, 9 **Control:** Mid Pivot Knee Tilt
Notes:

Fabric	List Price
Dual Layer Air Grid® Back and Black Mesh Seat	850.00

Big & Tall 400 lbs.



★ ⚙️ **75-47A773** Dual Layer Air Grid® Back and Black Bonded Leather Seat Ergonomic Chair with Adjustable Lumbar, 2-Way Adjustable Arms and Gunmetal Finish Base

Overall Size: 28.5W x 27D x 42.75 - 45.5H
Seat: 21.5W x 21D x 4.5T **Back:** 21.5W x 21.75H **Seat Range:** 20.25 - 23
Arms to Floor: 26 **Carton Wt:** 66 **UPS Wt:** 66 **COM:** N/A
Carton: 32L x 26W x 15H **Cube:** 7.22
Options: CG50, SW70 **Features:** 1, 4, 6, 8, 9 **Control:** Mid Pivot Knee Tilt
Notes:

Fabric	List Price
Dual Layer Air Grid® Back and Black Bonded Leather Seat	925.00

Big & Tall 400 lbs.



75-47A773



★ NJ In Stock

⚙️ TAA Compliant

86 REVV® Series



⚙️ **86-M22C625R** Self Adjusting Ice SpaceFlex® Back and Shadow Mesh Seat Manager's Chair with Adjustable Arms and Platinum Finish Base
 🌿
Overall Size: 27.25W x 24D x 44H
Seat: 19.25W x 19.5D x 4.5T **Back:** 21W x 19H **Seat Range:** 18.25-22.5
Arms to Floor: 24.75 **Carton Wt:** 50 **UPS Wt:** 53 **COM:** N/A
Carton: 32L x 26W x 13H **Cube:** 6.25 **Options:** CG50, SW70
Features: 1, 4, 8, 9, 14 **Control:** Self Adjusting 4-to-1 Synchro Tilt
Notes:

Fabric	List Price
Ice SpaceFlex® Back and Shadow Mesh Seat	675.00
Self Adjusting Mechanism	



⚙️ **86-M32C625R** Self Adjusting Ice SpaceFlex® Back and Raven Mesh Seat Manager's Chair with Adjustable Arms and Platinum Finish Base
 🌿
Overall Size: 27.25W x 24D x 44H
Seat: 19.25W x 19.5D x 4.5T **Back:** 21W x 19H **Seat Range:** 18.25-22.5
Arms to Floor: 24.75 **Carton Wt:** 50 **UPS Wt:** 53 **COM:** N/A
Carton: 32L x 26W x 13H **Cube:** 6.25 **Options:** CG50, SW70
Features: 1, 4, 8, 9, 14 **Control:** Self Adjusting 4-to-1 Synchro Tilt
Notes:

Fabric	List Price
Ice SpaceFlex® Back and Raven Mesh Seat	675.00
Self Adjusting Mechanism	



★ ⚙️ **86-M33BN2W** Self Adjusting Raven SpaceFlex® Back and Raven Mesh Seat Manager's Chair with Adjustable Arms and Nylon Base
 🌿
Overall Size: 27.25W x 24D x 44H
Seat: 19.25W x 19.5D x 4.5T **Back:** 21W x 19H **Seat Range:** 18.25-22.5
Arms to Floor: 24.75 **Carton Wt:** 50 **UPS Wt:** 53 **COM:** N/A
Carton: 32L x 26W x 13H **Cube:** 6.25 **Options:** CG50, SW70
Features: 1, 4, 8, 9, 14 **Control:** Self Adjusting 4-to-1 Synchro Tilt
Notes:

Fabric	List Price
Raven SpaceFlex® Back and Raven Mesh Seat	625.00
Self Adjusting Mechanism	



⚙️ **86-M33C625R** Self Adjusting Raven SpaceFlex® Back and Raven Mesh Seat Manager's Chair with Adjustable Arms and Platinum Finish Base
 🌿
Overall Size: 27.25W x 24D x 44H
Seat: 19.25W x 19.5D x 4.5T **Back:** 21W x 19H **Seat Range:** 18.25-22.5
Arms to Floor: 24.75 **Carton Wt:** 50 **UPS Wt:** 53 **COM:** N/A
Carton: 32L x 26W x 13H **Cube:** 6.25 **Options:** CG50, SW70
Features: 1, 4, 8, 9, 14 **Control:** Self Adjusting 4-to-1 Synchro Tilt
Notes:

Fabric	List Price
Raven SpaceFlex® Back and Raven Mesh Seat	675.00
Self Adjusting Mechanism	



⚙️ **86-M34C625R** Self Adjusting Fog SpaceFlex® Back and Raven Mesh Seat Manager's Chair with Adjustable Arms and Platinum Finish Base
 🌿
Overall Size: 27.25W x 24D x 44H
Seat: 19.25W x 19.5D x 4.5T **Back:** 21W x 19H **Seat Range:** 18.25-22.5
Arms to Floor: 24.75 **Carton Wt:** 50 **UPS Wt:** 53 **COM:** N/A
Carton: 32L x 26W x 13H **Cube:** 6.25 **Options:** CG50, SW70
Features: 1, 4, 8, 9, 14 **Control:** Self Adjusting 4-to-1 Synchro Tilt
Notes:

Fabric	List Price
Fog SpaceFlex® Back and Raven Mesh Seat	675.00
Self Adjusting Mechanism	



⚙️ **86-M35C625R** Self Adjusting Tang SpaceFlex® Back and Raven Mesh Seat Manager's Chair with Adjustable Arms and Platinum Finish Base
 🌿
Overall Size: 27.25W x 24D x 44H
Seat: 19.25W x 19.5D x 4.5T **Back:** 21W x 19H **Seat Range:** 18.25-22.5
Arms to Floor: 24.75 **Carton Wt:** 50 **UPS Wt:** 53 **COM:** N/A
Carton: 32L x 26W x 13H **Cube:** 6.25 **Options:** CG50, SW70
Features: 1, 4, 8, 9, 14 **Control:** Self Adjusting 4-to-1 Synchro Tilt
Notes:

Fabric	List Price
Tang SpaceFlex® Back and Raven Mesh Seat	675.00
Self Adjusting Mechanism	



86-M39C625R Self Adjusting Cosmo SpaceFlex® Back and Raven Mesh Seat Manager's Chair with Adjustable Arms and Platinum Finish Base
Overall Size: 27.25W x 24D x 44H
Seat: 19.25W x 19.5D x 4.5T **Back:** 21W x 19H **Seat Range:** 18.25-22.5
Arms to Floor: 24.75 **Carton Wt:** 50 **UPS Wt:** 53 **COM:** N/A
Carton: 32L x 26W x 13H **Cube:** 6.25 **Options:** CG50, SW70
Features: 1, 4, 8, 9, 14 **Control:** Self Adjusting 4-to-1 Synchro Tilt
Notes:

Fabric	List Price
Cosmo SpaceFlex® Back and Raven Mesh Seat	675.00
Self Adjusting Mechanism	



86-M66C625R Self Adjusting Kiwi SpaceFlex® Back and Kiwi Mesh Seat Manager's Chair with Adjustable Arms and Platinum Finish Base
Overall Size: 27.25W x 24D x 44H
Seat: 19.25W x 19.5D x 4.5T **Back:** 21W x 19H **Seat Range:** 18.25-22.5
Arms to Floor: 24.75 **Carton Wt:** 50 **UPS Wt:** 53 **COM:** N/A
Carton: 32L x 26W x 13H **Cube:** 6.25 **Options:** CG50, SW70
Features: 1, 4, 8, 9, 14 **Control:** Self Adjusting 4-to-1 Synchro Tilt
Notes:

Fabric	List Price
Kiwi SpaceFlex® Back and Kiwi Mesh Seat	675.00
Self Adjusting Mechanism	



86-M74C625R Self Adjusting Fog SpaceFlex® Back and Blue Mist Mesh Seat Manager's Chair with Adjustable Arms and Platinum Finish Base
Overall Size: 27.25W x 24D x 44H
Seat: 19.25W x 19.5D x 4.5T **Back:** 21W x 19H **Seat Range:** 18.25-22.5
Arms to Floor: 24.75 **Carton Wt:** 50 **UPS Wt:** 53 **COM:** N/A
Carton: 32L x 26W x 13H **Cube:** 6.25 **Options:** CG50, SW70
Features: 1, 4, 8, 9, 14 **Control:** Self Adjusting 4-to-1 Synchro Tilt
Notes:

Fabric	List Price
Fog SpaceFlex® Back and Blue Mist Mesh Seat	675.00
Self Adjusting Mechanism	



86-M77C625R Self Adjusting Blue Mist SpaceFlex® Back and Blue Mist Mesh Seat Manager's Chair with Adjustable Arms and Platinum Finish Base
Overall Size: 27.25W x 24D x 44H
Seat: 19.25W x 19.5D x 4.5T **Back:** 21W x 19H **Seat Range:** 18.25-22.5
Arms to Floor: 24.75 **Carton Wt:** 50 **UPS Wt:** 53 **COM:** N/A
Carton: 32L x 26W x 13H **Cube:** 6.25 **Options:** CG50, SW70
Features: 1, 4, 8, 9, 14 **Control:** Self Adjusting 4-to-1 Synchro Tilt
Notes:

Fabric	List Price
Blue Mist SpaceFlex® Back and Blue Mist Mesh Seat	675.00
Self Adjusting Mechanism	



86-M88C625R Self Adjusting Latte SpaceFlex® Back and Latte Mesh Seat Manager's Chair with Adjustable Arms and Platinum Finish Base
Overall Size: 27.25W x 24D x 44H
Seat: 19.25W x 19.5D x 4.5T **Back:** 21W x 19H **Seat Range:** 18.25-22.5
Arms to Floor: 24.75 **Carton Wt:** 50 **UPS Wt:** 53 **COM:** N/A
Carton: 32L x 26W x 13H **Cube:** 6.25 **Options:** CG50, SW70
Features: 1, 4, 8, 9, 14 **Control:** Self Adjusting 4-to-1 Synchro Tilt
Notes:

Fabric	List Price
Latte SpaceFlex® Back and Latte Mesh Seat	675.00
Self Adjusting Mechanism	

Pulsar Series



86W-2C12F2W White Self Adjusting SpaceFlex® Back and Padded Mesh Seat Manager's Chair with Height Adjustable Flip Arms and Coated Nylon Base
Overall Size: 27.25W x 24D x 44H
Seat: 19.25W x 19.5D x 4.5T **Back:** 21W x 19H **Seat Range:** 18.25-22.5
Arms to Floor: 24.75 **Carton Wt:** 49 **UPS Wt:** 53 **COM:** .75 yds
Carton: 32L x 26W x 13H **Cube:** 6.25 **Options:** CG50, SW70
Features: 1, 4, 8, 9, 14 **Control:** Self Adjusting 4-to-1 Synchro Tilt
Notes: Available in Fun Colors - see page 24.

Fabric	List Price
White SpaceFlex® Back & Mesh Seat	700.00
 (Seat Only)	
Self Adjusting Mechanism	

FUN
COLORS
FABRIC PROGRAM



-3M Black

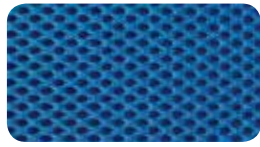

-5 Royal Blue

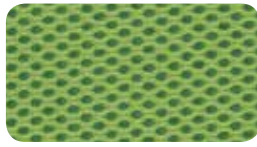

-6 Green

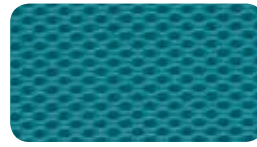

-7 Blue



-9 Red



-18 Orange

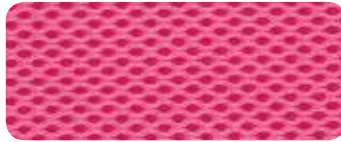

-261 Pink

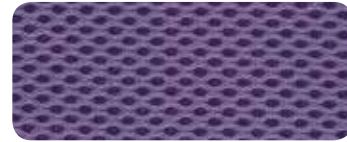

-512 Purple



5200W-5811



317W-W1C1F2W-3M



86W-2C12F2W

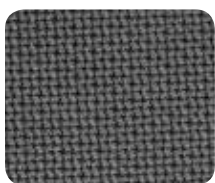

-5811 Steel



-5812 Rouge

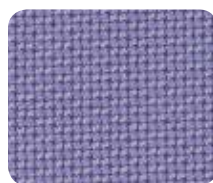

-5819 Violet

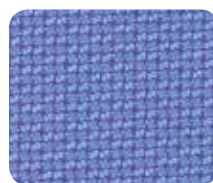

-5877 Sky

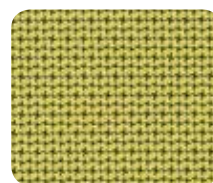

-5879 Olive



-5881 Jade



848W Nesting Chair with Breathable Mesh Back and Fabric Padded Seat in White Finish Frame.

Overall Size: 25W x 23.5D x 35.25H
Seat: 17.5W x 19D x 2T **Back:** 19.75W x 16.5H **Seat Range:** 19.5 Fixed
Arms to Floor: 27 **Carton Wt:** 56 **UPS Wt:** 79 **COM:** 1 yd.
Carton: 26L x 26W x 24H **Cube:** 9.38
Options: CG50 **Features:** N/A **Control:** N/A
Notes: Seat Folds Up for Horizontal Nesting. Sold in 2-Pack. Set of 2 Clips for Ganging Included. Available in Fun Colors - see below.

Fabric	List Price
Flex Back and Fabric Padded Seat	570.00 2-Pack
 (Seat only) 250 lbs.	



5200W White Frame Finish Manager's Chair with Padded Mesh Seat and Back, Height Adjustable Flip Arms and Coated Nylon Base

Overall Size: 26W x 26.75D x 38H
Seat: 20.5W x 19.5D x 3.5T **Back:** 20.5W x 19H x 1.25T **Seat Range:** 16.75-19.5
Arms to Floor: 23.5 **Carton Wt:** 44 **UPS Wt:** 56 **COM:** 1.5 yds.
Carton: 28L x 27W x 15H **Cube:** 6.5
Options: CG50, SW70 **Features:** 1, 4, 7, 8, 9 **Control:** 2-to-1 Synchro Tilt
Notes: -3 available in NJ. Available in Fun Colors - see page 24.

Fabric	List Price
Fun Colors (Seat and Back)	525.00
	



317W-W11C1F2W White Frame Manager's Chair with Breathable Mesh Seat and Back, Adjustable Padded Flip Arms and Coated Nylon Base

Overall Size: 28.5W x 26.25D x 42.75H
Seat: 21.25W x 19.75D **Back:** 22W x 22.75H **Seat Range:** 17.75-20.25
Arms to Floor: 25.5 **Carton Wt:** 45 **UPS Wt:** 53 **COM:** N/A
Carton: 32L x 26W x 13H **Cube:** 6.25
Options: CG50, SW70 **Features:** 1, 4, 7, 8, 9 **Control:** 2-to-1 Synchro Tilt
Notes:

Fabric	List Price
White Breathable Mesh Seat and Back	795.00



317W-W1C1F2W White Frame Manager's Chair with Breathable Mesh Back and Padded Mesh Seat Manager's Chair with Height Adjustable Flip Arms and Coated Nylon Base

Overall Size: 26W x 24.75D x 44.75H
Seat: 20.75W x 19.5D x 3.5T **Back:** 18.5W x 22.25H **Seat Range:** 18.75-23
Arms to Floor: 25.5 **Carton Wt:** 45 **UPS Wt:** 53 **COM:** .75 yd.
Carton: 32L x 26W x 13H **Cube:** 6.25
Options: CG50, SW70 **Features:** 1, 4, 7, 8, 9 **Control:** 2-to-1 Synchro Tilt
Notes: Available in Fun Colors - see page 24.

Fabric	List Price
White Breathable Mesh Back and Padded Mesh Seat	750.00
-3M Black	
 (Seat only)	770.00



9333E Black Bonded Leather Conference Chair with Cantilever Arms and Gunmetal Finish Base

Overall Size: 27.5W x 28.25D x 45H
Seat: 22W x 20D x 5.25T **Back:** 21W x 24H x 5T **Seat Range:** 18.75-23.5
Arms to Floor: 28 **Carton Wt:** 58 **UPS Wt:** 58 **COM:** N/A
Carton: 30L x 26W x 15H **Cube:** 6.77
Options: CG50, SW70 **Features:** 1, 4, 7, 8, 9 **Control:** 2-to-1 Synchro Tilt
Notes: Transitioned to Bonded Leather. **REPLACES** 9333.

Fabric	List Price
Black Bonded Leather Seat and Back	685.00



215-3R2C62R5 Deluxe R2 SpaceGrid Back Chair with Mesh Seat, Self Adjusting Control, Platinum Finish Flip Arms and Platinum Coated Base with Black End Caps

Overall Size: 27.5W x 25.25D x 44H
Seat: 20.75W x 20D x 4T **Back:** 22.5W x 28H **Seat Range:** 17.75-22
Arms to Floor: 26.5 **Carton Wt:** 52 **UPS Wt:** 52 **COM:** N/A
Carton: 31L x 26W x 13H **Cube:** 6.06 **Options:** CG50, SW70
Features: 1, 4, 9, 14 **Control:** Self Adjusting 4-to-1 Synchro Tilt
Notes:

Fabric/Frame	List Price
R2 SpaceGrid Back and Black Mesh Seat	595.00

215 and 317 Series



⚙️ **215-E3T17C1A8** Black Vertical Mesh Back Chair w/Bonded Leather Seat, Height & Depth Adjustable Lumbar Support, Height Adjustable Arms and Polished Aluminum Base

Overall Size: 27.25W x 25D x 39-43.25H
Seat: 21.5W x 20D x 3.5T **Back:** 22.5W x 22.75H **Seat Range:** 18.75-23
Arms to Floor: 24.5 **Carton Wt:** 47 **UPS Wt:** 55 **COM:** N/A
Carton: 31L x 26W x 14H **Cube:** 6.5 **Options:** CG50, SW70
Features: 1, 4, 7, 8, 9, 15 **Control:** 2-to-1 Synchro Tilt
Notes:

NEW

Fabric/Frame	List Price
Black Vertical Mesh Back and Black Bonded Leather Seat	695.00



⚙️ **215-TG117C1A8** Grey Vertical Mesh Seat and Back, Height & Depth Adjustable Lumbar Support, Height Adjustable Arms and Polished Aluminum Base

Overall Size: 27.25W x 25D x 39-43.25H
Seat: 21.5W x 20.25D **Back:** 22.5W x 22.75H **Seat Range:** 17.5-21.75
Arms to Floor: 24.5 **Carton Wt:** 47 **UPS Wt:** 55 **COM:** N/A
Carton: 31L x 26W x 14H **Cube:** 6.5 **Options:** CG50, SW70
Features: 1, 4, 7, 8, 9, 15 **Control:** 2-to-1 Synchro Tilt
Notes:

NEW

Fabric/Frame	List Price
Grey Vertical Mesh Seat and Back	795.00

317 Series



⚙️ **317-ME3R2C6KF6** Professional R2 SpaceGrid Back Chair w/Memory Foam Bonded Leather Seat, Platinum Finish Flip Arms, Seat Slider and Platinum Coated Base w/Black End Caps

Overall Size: 28.5W x 26D x 43.25H
Seat: 20.5W x 19.25D x 4T **Back:** 22W x 22.75H **Seat Range:** 18.5-21
Arms to Floor: 26.5 **Carton Wt:** 53 **UPS Wt:** 53 **COM:** N/A
Carton: 32L x 26W x 13H **Cube:** 6.25 **Options:** CG50, SW70
Features: 1, 3, 4, 7, 8, 9, 15 **Control:** Deluxe 2-to-1 with Seat Slider
Notes:

Seat Slider

Fabric	List Price
R2 SpaceGrid Back and Black Bonded Leather Seat	775.00



★ ⚙️ **317-R22C6KF6** Professional R2 SpaceGrid Seat and Back Chair with Platinum Finish Flip Arms, Seat Slider and Platinum Coated Base with Black End Caps

Overall Size: 28.5W x 26.25D x 43.25H
Seat: 21.25W x 19.75D **Back:** 22W x 22.75H **Seat Range:** 17.75-20.25
Arms to Floor: 26.25 **Carton Wt:** 55 **UPS Wt:** 55 **COM:** N/A
Carton: 32L x 26W x 13H **Cube:** 6.26 **Options:** CG50, SW70
Features: 1, 3, 4, 7, 8, 9, 15 **Control:** Deluxe 2-to-1 with Seat Slider
Notes:

Seat Slider

Fabric	List Price
R2 SpaceGrid Seat and Back	850.00



★ ⚙️ **317-ME3R2C7KF7** Professional R2 SpaceGrid Back Chair with Memory Foam Bonded Leather Seat, Gunmetal Adjustable Flip Arms and Gunmetal Coated Base with Black End Caps

Overall Size: 28.5W x 26D x 43.25H
Seat: 20.5W x 19.25D x 4T **Back:** 22W x 22.75H **Seat Range:** 18.5-21
Arms to Floor: 26.5 **Carton Wt:** 55 **UPS Wt:** 55 **COM:** N/A
Carton: 32L x 26W x 13H **Cube:** 6.26 **Options:** CG50, SW70
Features: 1, 3, 4, 7, 8, 9, 15 **Control:** Deluxe 2-to-1 with Seat Slider
Notes:

Seat Slider

Fabric	List Price
R2 SpaceGrid Back and Black Bonded Leather Seat	775.00



★ ⚙️ **317-R22C7KF7** Professional R2 SpaceGrid Seat and Back Chair with Gunmetal Adjustable Flip Arms, Seat Slider and Gunmetal Coated Base with Black End Caps

Overall Size: 28.5W x 26.25D x 43.25H
Seat: 21.25W x 19.75D **Back:** 22W x 22.75H **Seat Range:** 17.75-20.25
Arms to Floor: 26.25 **Carton Wt:** 55 **UPS Wt:** 55 **COM:** N/A
Carton: 32L x 26W x 13H **Cube:** 6.26 **Options:** CG50, SW70
Features: 1, 3, 4, 7, 8, 9, 15 **Control:** Deluxe 2-to-1 with Seat Slider
Notes:

Seat Slider

Fabric	List Price
R2 SpaceGrid Seat and Back	850.00



⚙️ **317-ME36C61F6** Professional Light AirGrid® Back Chair w/Black Bonded Leather Seat, Memory Foam, Platinum Finish Flip Arms & Platinum Coated Base w/Black End Caps
 🌿 **Overall Size:** 28.5W x 23.75D x 44.25H
Seat: 20.5W x 19.25D x 4T **Back:** 22W x 22.75H **Seat Range:** 18.5-22.75
Arms to Floor: 27 **Carton Wt:** 47 **UPS Wt:** 53 **COM:** N/A
Carton: 32L x 26W x 13H **Cube:** 6.26
Options: SW70 **Features:** 1, 4, 7, 8, 9 **Control:** 2-to-1 Synchro Tilt
Notes:

Fabric	List Price
Light AirGrid® Back and Black Bonded Leather Seat	625.00



★ ⚙️ **317-66C61F6** Professional Light AirGrid® Seat and Back Chair with Platinum Finish Flip Arms and Platinum Coated Base with Black End Caps
 🌿 **Overall Size:** 28.5W x 23.75D x 44.25H
Seat: 21.5W x 19.75D **Back:** 22W x 22.75H **Seat Range:** 18.5-22.5
Arms to Floor: 26.75 **Carton Wt:** 48 **UPS Wt:** 53 **COM:** N/A
Carton: 32L x 26W x 13H **Cube:** 6.26
Options: SW70 **Features:** 1, 4, 7, 8, 9 **Control:** 2-to-1 Synchro Tilt
Notes:

Fabric	List Price
Light AirGrid® Back and Seat	695.00



★ ⚙️ **335-E37P918P** Professional Air Grid® Back Chair with Black Bonded Leather Seat and Trim, Adjustable Arms, Adjustable Lumbar, and Angled Polished Aluminum Base
 🌿 **Overall Size:** 28W x 25.75D x 45H
Seat: 20W x 19D x 3T **Back:** 20.5W x 23H **Seat Range:** 18.25-22.25
Arms to Floor: 24.75 **Carton Wt:** 43 **UPS Wt:** 53 **COM:** N/A
Carton: 32L x 26W x 13H **Cube:** 6.25
Options: SW392 **Features:** 1, 4, 7, 8, 9 **Control:** 2-to-1 Synchro Tilt
Notes: REPLACES 335-47P918P

Fabric	List Price
Air Grid® Back and Black Bonded Leather Seat and Trim	695.00

529 Series



★ ⚙️ **529-3R2N1F2** R2 SpaceGrid Back Chair with Memory Foam Mesh Seat, Height Adjustable Flip Arms, Adjustable Lumbar and Nylon Base
 🌿 **Overall Size:** 27.5W x 25.5D x 43H
Seat: 20.75W x 19.5D x 4T **Back:** 22.25W x 28H **Seat Range:** 17.75-22
Arms to Floor: 25.75 **Carton Wt:** 43 **UPS Wt:** 51 **COM:** 1 yd.
Carton: 31L x 26W x 13H **Cube:** 6.06
Options: CG50, SW70 **Features:** 1, 4, 7, 8, 9 **Control:** 2-to-1 Synchro Tilt
Notes: Available in Fun Colors - see page 24. Patent # US D660,621 S

Fabric/Frame	List Price
R2 SpaceGrid Back and Black Mesh Seat	550.00
 (Seat only)	570.00



⚙️ **529-M3R2N6F2** R2 SpaceGrid Back Chair with Memory Foam Mesh Seat, Height Adjustable Flip Arms, Adjustable Lumbar, Seat Slider and Nylon Base
Overall Size: 26.25W x 25.25D x 43H
Seat: 20.5W x 19.5D x 4.5T **Back:** 22.5W x 27.25H **Seat Range:** 19.5-24
Arms to Floor: 25.5 **Carton Wt:** 47 **UPS Wt:** 51 **COM:** 1 yd. **NEW**
Carton: 31L x 26W x 13H **Cube:** 6.06 **Options:** CG50, SW70
Features: 1, 4, 7, 8, 9, 15 **Control:** 2-to-1 Synchro Tilt with 3 Position Lock
Notes: Available in Fun Colors - see page 24. 3-Position Lock with Anti-Kick Control.
Seat Slider

Fabric/Frame	List Price
R2 SpaceGrid Back and Black Mesh Seat	625.00
 (Seat only)	645.00



★ ⚙️ **529-ME3R2N6F2** R2 SpaceGrid Back Chair with Memory Foam Bonded Leather Seat, Height Adjustable Flip Arms, Adjustable Lumbar, Seat Slider and Nylon Base
Overall Size: 26.25W x 25.25D x 43H
Seat: 20.5W x 19.5D x 4.5T **Back:** 22.5W x 27.25H **Seat Range:** 19.5-24
Arms to Floor: 25.5 **Carton Wt:** 48 **UPS Wt:** 51 **COM:** N/A **NEW**
Carton: 31L x 26W x 13H **Cube:** 6.06 **Options:** CG50, SW70
Features: 1, 4, 7, 8, 9, 15 **Control:** 2-to-1 Synchro Tilt with 3 Position Lock
Notes: 3-Position Lock with Anti-Kick Control.
Seat Slider

Fabric/Frame	List Price
R2 SpaceGrid Back and Black Bonded Seat	625.00



⚙️ **529-R2N1F2** R2 SpaceGrid Back Chair with Memory Foam Mesh Seat, Height Adjustable Flip Arms, Adjustable Lumbar and Nylon Base

🌱 **Overall Size:** 27.5W x 25.5D x 43H
Seat: 20.75W x 19.5D x 4T **Back:** 22.25W x 28H **Seat Range:** 17.75-22
Arms to Floor: 25.75 **Carton Wt:** 43 **UPS Wt:** 51 **COM:** 1 yd.
Carton: 31L x 26W x 13H **Cube:** 6.06
Options: CG50, SW70 **Features:** 1, 4, 7, 8, 9 **Control:** 2-to-1 Synchro Tilt
Notes:



Fabric/Frame	List Price
R2 SpaceGrid Back	
A	580.00
B	610.00
C	642.00
R	695.00



★ ⚙️ **529-E3R2N1F2** R2 SpaceGrid Back Chair with Memory Foam Bonded Leather Seat, Height Adjustable Flip Arms, Adjustable Lumbar and Nylon Base

🌱 **Overall Size:** 27.5W x 25.5D x 43H
Seat: 20.75W x 19.5 x 4T **Back:** 22.25W x 28H **Seat Range:** 17.75-22
Arms to Floor: 25.75 **Carton Wt:** 43 **UPS Wt:** 51 **COM:** N/A
Carton: 31L x 26W x 13H **Cube:** 6.06 **Cube:** 4.34
Options: CG50, SW70 **Features:** 1, 4, 7, 8, 9 **Control:** 2-to-1 Synchro Tilt
Notes: Patent # US D660,621 S

Fabric/Frame	List Price
R2 SpaceGrid Back and Black Bonded Leather Seat	550.00



★ ⚙️ **529-R22N1F2** R2 SpaceGrid Seat and Back Chair with Height Adjustable Flip Arms, Adjustable Lumbar and Nylon Base

🌱 **Overall Size:** 27.5W x 25.5D x 43H
Seat: 20.75W x 19.5 x 4T **Back:** 22.25W x 28H **Seat Range:** 17.75-22
Arms to Floor: 25.5 **Carton Wt:** 43 **UPS Wt:** 47 **COM:** N/A
Carton: 31L x 26W x 12H **Cube:** 5.59
Options: CG50, SW70 **Features:** 1, 4, 7, 8, 9 **Control:** 2-to-1 Synchro Tilt
Notes: Patent # US D660,621 S

Fabric	List Price
R2 SpaceGrid Back and Seat	595.00



★ ⚙️ **529-3R2V30** Deluxe R2 SpaceGrid Back Visitor's Chair with Mesh Seat, Adjustable Lumbar, Fixed Arms and Sled Base

🌱 **Overall Size:** 25.5W x 23.25D x 39.5H
Seat: 20.5W x 19D x 4T **Back:** 22.5W x 27.5H **Seat Range:** 19 Fixed
Arms to Floor: 25.75 **Carton Wt:** 38 **UPS Wt:** 54 **COM:** 1 yd.
Carton: 30L x 23W x 16H **Cube:** 6.38 **Options:** N/A
Features: N/A **Control:** N/A
Notes: Available in Fun Colors - see page 24.

Fabric	List Price
R2 SpaceGrid Back and Black Mesh Seat	450.00
 (Seat only)	470.00



★ ⚙️ **529-E3R2V30** Deluxe R2 SpaceGrid Back Visitor's Chair with Bonded Leather Seat, Adjustable Lumbar, Fixed Arms and Sled Base and Fixed Arms

🌱 **Overall Size:** 25.5W x 23.25D x 39.5H
Seat: 20.5W x 19D x 4T **Back:** 22.5W x 27.5H **Seat Range:** 19 Fixed
Arms to Floor: 25.75 **Carton Wt:** 36 **UPS Wt:** 54 **COM:** N/A
Carton: 30L x 23W x 16H **Cube:** 6.38 **Options:** N/A
Features: N/A **Control:** N/A
Notes:

Fabric	List Price
R2 SpaceGrid Back and Black Bonded Leather Seat	470.00



★ ⚙️ **657-3TW1N1421W** White Vertical Mesh Back Chair with Height Adjustable Lumbar Support, Black Mesh Seat, Height Adjustable Padded Arms and White Angled Nylon Base

🌱 **Overall Size:** 26.75W x 25.25D x 39.5-43.75H
Seat: 20.5W x 19D x 3.5T **Back:** 19.5W x 22.75H **Seat Range:** 18.25-22.5
Arms to Floor: 26.75 **Carton Wt:** 50 **UPS Wt:** 57 **COM:** 1 yd.
Carton: 32L x 26W x 14H **Cube:** 6.74 **Options:** N/A
Features: 1, 4, 7, 8, 9, 15 **Control:** 2-to-1 Synchro Tilt
Notes: Available in Fun Colors - see page 24.

NEW

Seat Slider

Fabric	List Price
White Vertical Mesh Back and Black Mesh Seat	825.00
 (Seat only)	825.00



★ **657-7TG1N4421G** Grey Vertical Mesh Back Chair with Height Adjustable Lumbar Support, Blue Fabric Seat, Height Adjustable Padded Arms and Graphite Angled Nylon Base

⚙️
Overall Size: 26.75W x 25.25D x 39.5-43.75H
Seat: 20.5W x 19D x 3.5T **Back:** 19.5W x 22.75H **Seat Range:** 18-22
Arms to Floor: 26.75 **Carton Wt:** 50 **UPS Wt:** 57 **COM:** 1 yd.
Carton: 32L x 26W x 14H **Cube:** 6.74 **Options:** N/A
Features: 1, 4, 7, 8, 9, 15 **Control:** 2-to-1 Synchro Tilt
Notes: Available in Fun Colors - see page 24.

NEW

Seat Slider

Fabric	List Price
Grey Vertical Mesh Back and Blue Mesh Seat	800.00
 (Seat only)	800.00



★ **657-T11N6421R** Black Vertical Mesh Seat and Back Chair with Height Adjustable Lumbar Support, Height Adjustable Padded Arms and Silver Angled Nylon Base

⚙️
Overall Size: 27W x 26.75D x 39.5-43.75H
Seat: 21.5W x 19.75D **Back:** 19W x 22H **Seat Range:** 18-22.25
Arms to Floor: 26.75 **Carton Wt:** 51 **UPS Wt:** 57 **COM:** N/A
Carton: 32L x 26W x 14H **Cube:** 6.74 **Options:** N/A
Features: 1, 4, 7, 8, 9, 15 **Control:** 2-to-1 Synchro Tilt
Notes:

NEW

Seat Slider

Fabric	List Price
Black Vertical Mesh Seat and Back	895.00



★ **657-E3T17C63C** Black Vertical Mesh Back Chair with Height Adjustable Lumbar Support, Black Bonded Seat, Height Adjustable Padded Arms and Polished Aluminum Base

⚙️
Overall Size: 27W x 31D x 39.25-43.25H
Seat: 20.5W x 18.75D x 3.5T **Back:** 19W x 22H **Seat Range:** 17.5-21.75
Arms to Floor: 24.75 **Carton Wt:** 53 **UPS Wt:** 57 **COM:** N/A
Carton: 32L x 26W x 14H **Cube:** 6.74 **Options:** N/A
Features: 1, 4, 7, 8, 9, 15 **Control:** Deluxe 2-to-1 Synchro Tilt
Notes:

NEW

Seat Slider

Fabric	List Price
Black Vertical Mesh Back and Black Bonded Leather Seat	850.00



★ **818-11G9C18P** Breathable Mesh Back and Seat Executive Chair with Adjustable Arms and Lumbar, Seat Slider and Gunmetal Finish Angled Base

⚙️
Overall Size: 27.75W x 28.5D x 44H
Seat: 21.5W x 19.5D **Back:** 19.75W x 23H **Seat Range:** 17.75-20.25
Arms to Floor: 25.5 **Carton Wt:** 53 **UPS Wt:** 57 **COM:** N/A
Carton: 32L x 26W x 14H **Cube:** 6.74 **Options:** HRX818, A7U Arms, SW392
Features: 1, 3, 4, 7, 8, 9, 15 **Control:** Deluxe 2-to-1 w/Seat Slider
Notes: To Order with A7U Arms use Model# **818-11G9C1A7U**

Seat Slider

Fabric	List Price
Black Breathable Mesh Seat and Back	995.00
300 lbs.	



★ **818-31G9C18P** Breathable Mesh Back and Black Mesh Seat Executive Chair with Adjustable Arms and Lumbar, Seat Slider and Gunmetal Finish Angled Base

⚙️
Overall Size: 27.75W x 28.5D x 44H
Seat: 20W x 19D x 3T **Back:** 19.75W x 23H **Seat Range:** 17.75-20.25
Arms to Floor: 25.5 **Carton Wt:** 49 **UPS Wt:** 57 **COM:** N/A
Carton: 32L x 26W x 14H **Cube:** 6.74 **Options:** HRX818, HRM818, A7U Arm, SW392
Features: 1, 3, 4, 7, 8, 9, 15 **Control:** Deluxe 2-to-1 w/Seat Slider
Notes: To Order with A7U Arms use Model# **818-31G9C1A7U**

Seat Slider

Fabric	List Price
Black Breathable Mesh Back and Black Mesh Seat	875.00
300 lbs.	



★ **818-41G9C18P** Breathable Mesh Back and Black Leather Seat Executive Chair with Adjustable Arms and Lumbar, Seat Slider and Gunmetal Finish Angled Base

⚙️
Overall Size: 27.75W x 28.5D x 44H
Seat: 20W x 19D x 3T **Back:** 19.75W x 23H **Seat Range:** 17.75-20.25
Arms to Floor: 25.5 **Carton Wt:** 49 **UPS Wt:** 57 **COM:** N/A
Carton: 32L x 26W x 14H **Cube:** 6.74 **Options:** HRX818, HRL818, A7U Arm, SW392
Features: 1, 3, 4, 7, 8, 9, 15 **Control:** Deluxe 2-to-1 w/Seat Slider
Notes: To Order with A7U Arms use Model# **818-41G9C1A7U**

Seat Slider

Fabric	List Price
Black Breathable Mesh Back and Black Top Grain Genuine Leather Seat	950.00
300 lbs.	

818, 818A, 839 and 9370 Series



⚙️ **818A-11P9C1A8** Breathable Mesh Seat and Back Executive Chair with Adjustable Arms & Lumbar, Seat Slider and Polished Aluminum Finish Base
 🌿
Overall Size: 28W x 28.5D x 44H
Seat: 20W x 19D **Back:** 19.75W x 23H **Seat Range:** 17.75-20.25
Arms to Floor: 25.5 **Carton Wt:** 49 **UPS Wt:** 57 **COM:** N/A
Carton: 32L x 26W x 14H **Cube:** 6.74 **Options:** HRX818, A7U Arm, SW392
Features: 1, 3, 4, 7, 8, 9, 15 **Control:** Deluxe 2-to-1 w/Seat Slider
Notes: To Order with A7U Arms use Model# **818A-11P9C1A7U**
Seat Slider

Fabric	List Price
Black Breathable Mesh Seat and Back	995.00
300 lbs.	



⚙️ **818A-41P9C1A8** Breathable Mesh Back and Leather Seat Executive Chair with Adjustable Arms & Lumbar, Seat Slider and Polished Aluminum Finish Base
 🌿
Overall Size: 28W x 28.5D x 44H
Seat: 20W x 19D x 3T **Back:** 19.75W x 23H **Seat Range:** 17.75-20.25
Arms to Floor: 25.5 **Carton Wt:** 49 **UPS Wt:** 57 **COM:** N/A
Carton: 32L x 26W x 14H **Cube:** 6.74 **Options:** HRX818, A7U Arm, SW392
Features: 1, 3, 4, 7, 8, 9, 15 **Control:** Deluxe 2-to-1 w/Seat Slider
Notes: To Order with A7U Arms use Model# **818A-41P9C1A7U**
Seat Slider

Fabric	List Price
Black Breathable Mesh Back and Black Top Grain Genuine Leather Seat	995.00
300 lbs.	



★ **839-11B35WA** Breathable Mesh Back and Seat with 2-Way Adjustable Arms, Adjustable Lumbar, Deluxe Control, Anti Kick Back and Black Finish Base
 ⚙️
 🌿
Overall Size: 28.5W x 24D x 41.5H
Seat: 21.5W x 20D **Back:** 22.5W x 22.75H **Seat Range:** 17-19.75
Arms to Floor: 23.25 **Carton Wt:** 52 **UPS Wt:** 52 **COM:** N/A
Carton: 31L x 26W x 13H **Cube:** 6.06 **Options:** CG50, SW70
Features: 1, 4, 9, 14 **Control:** Deluxe 2-to-1 Control
Notes:
Big & Tall 400 lbs.

Fabric	List Price
Breathable Mesh Seat and Back	975.00



★ **9370-55NC17U** Leather Executive Chair with Soft PU Padded Adjustable Arms, Layered Seat and Back, Seat Slider and Nylon Base
 ⚙️
 🌿
Overall Size: 26.75W x 27.5D x 45.75H
Seat: 20.5W x 19.5D x 3T **Back:** 21.25W x 33H x 3T **Seat Range:** 16-19.5
Arms to Floor: 26 **Carton Wt:** 56 **UPS Wt:** 58 **COM:** N/A
Carton: 35L x 26W x 13H **Cube:** 6.85 **Options:** CG50, SW70
Features: 1, 3, 4, 7, 8, 9, 15 **Control:** Deluxe 2-to-1 with Seat Slider
Notes:
Seat Slider

Fabric	List Price
Leather Top Grain	850.00



★ **A15 Adjustable Arms**
 ⚙️ **Carton Wt:** 8 **Cube:** 0.88
 🌿 **Designed For:** 13-37N20D, 13-M22N20D, 13-37N30D, 13-7N20D, 13-77N20D & 13-37P500D only
List: 85.00



★ **HRM818 Mesh Headrest**
 ⚙️ **Overall Size:** 12.5W x 12.25H x 6.5D
 🌿 **Pad:** 12.5W x 7H **Height Adjustment:** 2.5
Carton Wt: 7 **Cube:** 0.63
Designed For: 818 Series only
List: 85.00



⚙️ **A7U Adjustable Soft Padded Arms**
Carton Wt: 7 **Cube:** 0.88
Designed For: Most 818, 818A and 829 Models only (see below for details)
List: 90.00



★ **HRL818 Leather Headrest**
 ⚙️ **Overall Size:** 12.5W x 12.25H x 6.5D
 🌿 **Pad:** 12.5W x 7H **Height Adjustment:** 2.5
Carton Wt: 7 **Cube:** 0.63
Designed For: 818 Series only
List: 100.00



★ **A27WA Adjustable Arms**
 ⚙️ **Carton Wt:** 9 **Cube:** 0.96
Designed For: 15-37A720D only
Note: Height and Width Adjustable, Big & Tall Drafting Chair
List: 98.00



★ **HRX818 Breathable Mesh Headrest**
 ⚙️ **Overall Size:** 12.5W x 12.25H x 6.5D
 🌿 **Pad:** 12.5W x 6H **Height Adjustment:** 2.5
Carton Wt: 7 **Cube:** 0.62
Designed For: 818 Series only
List: 100.00



★ **HRM003 Headrest**
 ⚙️ **Overall Size:** 15.25W x 8D x 13.5H
 🌿 **Pad:** 15.25W x 8.75H **Height Adjustment:** 4
Carton Wt: 5 **Cube:** 0.83
Designed For: 5540 only
List: 95.00



★ **EHL006 Bonded Leather Headrest**
 ⚙️ **Overall Size:** 15W x 9H x 6.5D
 🌿 **Pad:** 15W x 9H **Height Adjustment:** 3
Carton Wt: 4 **Cube:** 0.63
Designed For: 327-E36C61F6 & 327-66C61F6 and 36806
List: 90.00



★ **CG50 Floor Glides (set of 5)**
 ⚙️ **Carton Wt:** 2 **Cube:** 0.2
 🌿 **Designed For:** Most Work Smart Chairs & Space Drafting Chairs - See Individual Chair Options
List: 25.00 (set of 5)



★ **SW70 Soft Wheel Caster (set of 5)**
 ⚙️ **Carton Wt:** 2 **Cube:** 0.2
 🌿 **Designed For:** Most Work Smart Chairs & Space Chairs - See Individual Chair Options
List: 30.00 (set of 5)



★ **SW392 Soft Wheel Caster (set of 5)**
 ⚙️ **Carton Wt:** 2 **Cube:** 0.2
 🌿 **Designed For:** Angled Base Chairs See Individual Chair Options
Updated List: 32.00 (set of 5)

New Optional A7U Soft Padded Arm

Now Available on Most 818, 818A and 829 Models. The new A7U arm fits the following models.

818-11G9C18P 818-41G9C18P 818A-41P9C1A8
818-31G9C18P 818A-11P9C1A8

Example: 818-11G9C18P changes to 818-11G9C1A7U

Air Grid®



DuraFlex with Flow Thru Technology™

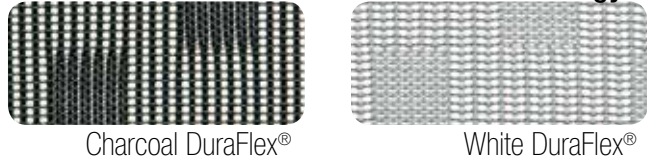

DuraGrid®

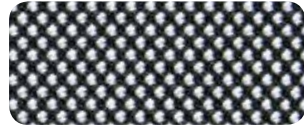

R2 SpaceGrid™



Breathable Mesh

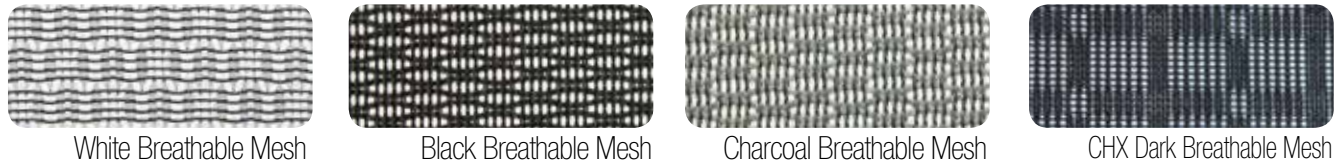

VeraFlex®



Color Mesh



SpaceFlex® Backs

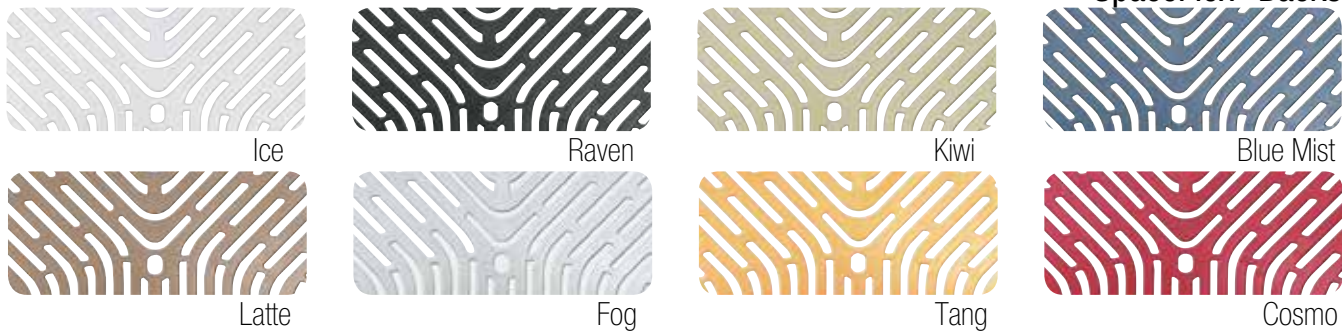

**FUN
COLORS
FABRIC PROGRAM**

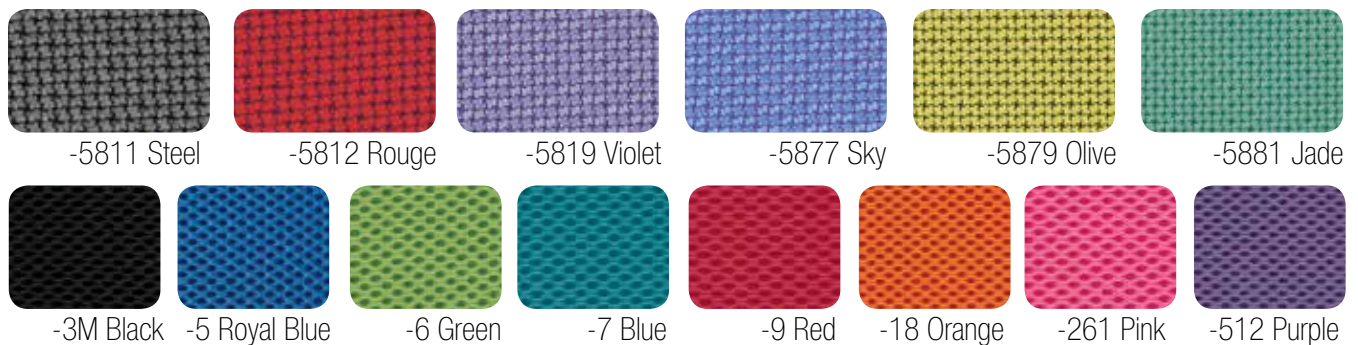



0 = T fixed arms



3 = 2-way adjustable arms: height and width



4 = 4-way adjustable arms: height, width, forward, reverse & lateral arm pad



5 = height adjustable arms



5R = platinum coated, height adjustable arms



7 = height adjustable arms



C8/8 = platinum coated, cantilever fixed arms



WA = 2-way adjustable arms: height and width



A8 = chrome accent, height adjustable arms



8P = black finish, height adjustable



C3 = polished aluminum, cantilever fixed arms



WP = height adjustable PP arms



P3 = black finish, cantilever fixed arms



A7U = height adjustable



A27WA = 2-way adjustable arms: height and width (15 draft chair only)



R5 = platinum coated, padded flip arms



WV = padded height adjustable arms (819-vinyl)



F2 = height adjustable flip arms



F3 = 4-way adjustable flip arms: height, width, forward, reverse & lateral arm pad



F6 = platinum coated, 4-way adjustable flip arms: height, width, forward, reverse & lateral arm pad



F7 = 4-way gunmetal adjustable flip arms: height, width, forward, reverse & lateral arm pad



06 = height adjustable arms



F2W = height adjustable flip arms



A15 = height adjustable arms

New 4-Way Adjustable Arms

213-37N2F3D
213-38N1F3
213-88N1F3
213-E37P91F3



Flip back

32-E3371F3
32-E3371F3HL
327-E36C61F6
327-66C61F6



Height adjustable

317-ME3R2C6KF6
317-R22C6KF6
317-ME3R2C7KF7
317-R22C7KF7



Arm pad forward



Arm pad backward

317-ME36C61F6
317-66C61F6

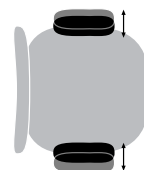

Arm pad side

LOUNGE



Shown:
PAC52 and PAC53
Arms, seat and back
beautifully wrapped in
Green (-M17) fabric.
See page 152.



Shown: ATL52 / ATL51
in -R101 Dillon Snow - see page 153.



**new
fabrics**



Choose OSP® Furniture to enhance any office environment with high-quality furnishings. With casegoods, conference and training tables, lounge and executive seating products, you'll find that OSP® Furniture excels in quality and attention to detail; offering enduring beauty for your office.

A grade fabric

Dillon (antimicrobial PVC Free Polyurethane)

Custom Upholstery Options



-R100 | Lipstick

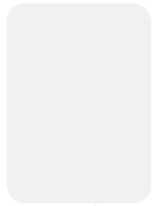

-R101 | Snow



-R102 | Java



-R103 | Stratus



-R104 | Buff



-R105 | Blue



-R106 | Sage



-R107 | Black

*PAC Collection recommended fabric option



PAC Collection beautifully wrapped in Grade A Dillon -R105 Blue (Antimicrobial)



Shown in: Dillon Blue -R105

★ **PAC51** Custom Fabric Pacific Arm Chair with Chrome Finish Legs

Overall Size: 32W x 30.5D x 29.5H
Seat: 23W x 22D x 5T
Back: 23.5W x 12.25H x 4.75T **Seat Height:** 17.5
Carton Wt: 49 **UPS Wt:** 102 **COM:** 6 yds.
Carton: 30L x 29W x 24H **Cube:** 12.08
Notes: UPSable, Oversized Package.

★ NJ In-Stock: -V18 Black, Dillon Fabrics.

For stock fabrics, please see page 152-153.

Fabric	Updated List Price
Chrome Finish	
Custom Fabric	
Dillon	575.00
A	575.00
B	635.00
C	685.00
R	795.00



Shown in: Dillon Blue -R105

★ **PAC52** Custom Fabric Pacific Loveseat with Chrome Finish Legs

Overall Size: 51.5W x 30.5D x 29.5H
Seat: 42W x 22D x 5T
Back: 42W x 12.25H x 4.75T **Seat Height:** 17.5
Carton Wt: 67 **UPS Wt:** 143 **COM:** 10 yds.
Carton: 43L x 31W x 22H **Cube:** 16.97
Notes: UPSable, Oversized Package.

★ NJ In-Stock: -V18 Black, Dillon Fabrics.

For stock fabrics, please see page 152-153.

Fabric	Updated List Price
Chrome Finish	
Custom Fabric	
Dillon	800.00
A	808.00
B	870.00
C	955.00
R	1100.00



Shown in: Dillon Blue -R105

★ **PAC53** Custom Fabric Pacific Sofa with Chrome Finish Legs

Overall Size: 72.5W x 30.5D x 29.5H
Seat: 63.5W x 22D x 5T
Back: 63.5W x 12.25H x 4.75T **Seat Height:** 17.5
Carton Wt: 90 **UPS Wt:** No UPS **COM:** 14 yds.
Carton: 64L x 31W x 22H **Cube:** 25.25
Notes: Non-UPSable.

★ NJ In-Stock: -V18 Black, Dillon Fabrics.

For stock fabrics, please see page 152-153.

Fabric	Updated List Price
Chrome Finish	
Custom Fabric	
Dillon	1125.00
A	1128.00
B	1210.00
C	1320.00
R	1495.00

★ NJ In Stock





ATL Collection in -R107 Dillon Black with SLVN12-PTWA Coffee Table



Shown in: Dillon Black -R107

★ **ATL51** Custom Fabric Atlantic Arm Chair with a Single UL Approved AC and USB 3.0 Charging Station, Chrome Finish Legs.
Overall Size: 32W x 30.5D x 29.5H
Seat: 23W x 22D x 5T
Back: 23.5W x 12.25H x 4.75T **Seat Height:** 17.5
Carton Wt: 53 **UPS Wt:** 102 **COM:** 6 yds.
Carton: 30L x 29W x 24H **Cube:** 12.08
Notes: UPSable, Oversized Package. **Single Power Unit.** UL Certified.
 ★ NJ In-Stock: -R101 Snow, -R107 Black & -R105 Dillon Blue.
For stock fabrics, please see page 153.

Fabric	Updated List Price
Chrome Finish	
Custom Fabric	
Dillon	670.00
A	695.00
B	760.00
C	800.00
R	875.00



Shown in: Dillon Black -R107

★ **ATL52** Custom Fabric Atlantic Loveseat with Dual UL Approved AC and USB 3.0 Charging Station, Chrome Finish Legs.
Overall Size: 51.5W x 30.5D x 29.5H
Seat: 42W x 22D x 5T
Back: 42.25W x 12.25H x 4.75T **Seat Height:** 17.5
Carton Wt: 72 **UPS Wt:** 143 **COM:** 10 yds.
Carton: 43L x 31W x 22H **Cube:** 16.97
Notes: UPSable, Oversized Package. **Dual Power Unit.** UL Certified.
 ★ NJ In-Stock: -R101 Snow, -R107 Black & -R105 Dillon Blue.
For stock fabrics, please see page 153.

Fabric	Updated List Price
Chrome Finish	
Custom Fabric	
Dillon	955.00
A	980.00
B	1045.00
C	1110.00
R	1200.00



Shown in: Dillon Black -R107

★ **ATL53** Custom Fabric Atlantic Sofa with Dual UL Approved AC and USB 3.0 Charging Station, Chrome Finish Legs
Overall Size: 72.5W x 30.5D x 29.5H
Seat: 63.5W x 22D x 5T
Back: 63.5W x 12.25H x 4.75T **Seat Height:** 17.5
Carton Wt: 100 **UPS Wt:** No UPS **COM:** 14 yds.
Carton: 64L x 31W x 22H **Cube:** 25.25
Notes: Non-UPSable. **Dual Power Unit.** UL Certified.
 ★ NJ In-Stock: -R101 Snow, -R107 Black & -R105 Dillon Blue.
For stock fabrics, please see page 153.

Fabric	Updated List Price
Chrome Finish	
Custom Fabric	
Dillon	1340.00
A	1395.00
B	1480.00
C	1575.00
R	1660.00

★ NJ In Stock



-R103 (arms) and -K101 (seat/back)

MST51 Custom Fabric Main Street Chair with Espresso Finish Wood Accents

Overall Size: 30W x 29.5D x 32H

Seat: 23.75W x 23D **Back:** 24.5W x 17H **Seat Height:** 18 **Arms to Floor:** 25.25

COM: Total: 5 yds **Seat & Back Only:** 3 yds **Arms Only:** 1.75 yds

Carton Wt: 56 **UPS Wt:** 89 **Carton:** 29L x 25W x 25H **Cube:** 10.49

Options: N/A **Features:** N/A **Control:** N/A

Notes: Rated for 265 lbs. of distributed weight

Fabric	Updated List Price
Espresso Finish with 2-Tone Custom Grade B Fabric Options	830.00
A	875.00
B	930.00
C	975.00
R	1080.00



-R103 (arms) and -K100 (seat/back)

MST52 Custom Fabric Main Street Loveseat with Espresso Finish Wood Accents

Overall Size: 49.25W x 29.5D x 32H

Seat: 43.5W x 22.5D **Back:** 44.5W x 17H **Seat Height:** 18 **Arms to Floor:** 25.25

COM: Total: 6 yds **Seat & Back Only:** 4 yds **Arms Only:** 1.75 yds

Carton Wt: 86 **UPS Wt:** 150 **Carton:** 46L x 29W x 23H **Cube:** 17.77

Options: N/A **Features:** N/A **Control:** N/A

Notes: Rated for 529 lbs. of distributed weight

Fabric	Updated List Price
Espresso Finish with 2-Tone Custom Grade B Fabric Options	1190.00
A	1035.00
B	1090.00
C	1150.00
R	1300.00



-R103 (arms) and -K100 (seat/back)

MST53 Custom Fabric Main Street Sofa with Espresso Finish Wood Accents

Overall Size: 75W x 30.75D x 32.75H

Seat: 69W x 21.5D **Back:** 69W x 27H **Seat Height:** 18.25 **Arms to Floor:** 26

COM: Total: 7.5 yds **Seat & Back Only:** 5.25 yds **Arms Only:** 1.75 yds

Carton Wt: 111 **UPS Wt:** No UPS **Carton:** 69L x 29W x 22H **Cube:** 25.47

Options: N/A **Features:** N/A **Control:** N/A

Notes: Rated for 650 lbs. of distributed weight

Fabric	Updated List Price
Espresso Finish with 2-Tone Custom Grade B Fabric Options	1925.00
A	1760.00
B	1850.00
C	1960.00
R	2185.00

B grade fabric Dillon/Fine Tune & City Park **2-Tone Custom Upholstery Options**

*MST51, MST52 and MST53 recommended fabric options. Not applicable on MST55.



Main Street Collection beautifully wrapped in Grade A Dillon -R103 Stratus with seat and back covered in Grade B Fine Tune -K102 Ash fabric



Shown in: Icon Black -231

SF8471 Custom Fabric Club Chair with Cherry Finish Legs.
Shipped Assembled with Legs Unmounted
Overall Size: 32W x 33.5D x 30.75H
Seat: 22W x 20D
Back: 22W x 16H **Seat Height:** 17.5
Carton Wt: 62 **UPS Wt:** No UPS **COM:** 6 yds
Carton: 34L x 33W x 30H **Cube:** 19.47
Notes: Rated for 300 lbs. of distributed weight
ANSI/BIFMA Tested

Fabric	Updated List Price
Cherry Finish	
Custom Fabric	
A	845.00
B	890.00
C	935.00
R	1000.00



Shown in: Icon Black -231

SF8472 Custom Fabric Loveseat with Cherry Finish Legs.
Shipped Assembled with Legs Unmounted
Overall Size: 58W x 33.5D x 30.75H
Seat: 48W x 20D
Back: 48W x 16H **Seat Height:** 17.5
Carton Wt: 91 **UPS Wt:** No UPS **COM:** 9 yds
Carton: 59L x 34W x 30H **Cube:** 34.82
Notes: Rated for 500 lbs. of distributed weight
ANSI/BIFMA Tested

Fabric	Updated List Price
Cherry Finish	
Custom Fabric	
A	1275.00
B	1345.00
C	1395.00
R	1500.00



Shown in: Icon Black -231

SF8473 Custom Fabric Sofa with Cherry Finish Legs.
Shipped Assembled with Legs Unmounted
Overall Size: 74.5W x 33.5D x 30.75H
Seat: 64W x 20D
Back: 64W x 16H **Seat Height:** 17.5
Carton Wt: 111 **UPS Wt:** No UPS **COM:** 12 yds
Carton: 79L x 34W x 30H **Cube:** 46.63
Notes: Rated for 675 lbs. of distributed weight
ANSI/BIFMA Tested

Fabric	Updated List Price
Cherry Finish	
Custom Fabric	
A	1600.00
B	1690.00
C	1780.00
R	1900.00



★ **SL4411** Mid-Century Club Chair with Coffee Finish Solid Wood Legs.
Shipped Assembled with Legs Unmounted
Overall Size: 30.5W x 31.75D x 33H
Seat: 23.5W x 21.25D x 5.5T
Back: 24.25W x 15H x 5.5T **Seat Height:** 18.25
Carton Wt: 53 **UPS Wt:** 121 **COM:** N/A
Carton: 32L x 31W x 25H **Cube:** 14.35
Notes: Rated for 400 lbs. of distributed weight. Assembly required.
 ★ NJ In-Stock: -MC4 Charcoal

NEW

Fabric	Updated List Price
Coffee Finish	
-MC2 Olive	785.00
-MC3 Navy	
-MC4 Charcoal	



★ **SL4422** Mid-Century Loveseat with Coffee Finish Solid Wood Legs.
Shipped Assembled with Legs Unmounted
Overall Size: 50W x 31.75D x 33H
Seat: 43.25W x 21.25D x 5.5T
Back: 44.5W x 15H x 5.5T **Seat Height:** 18.25
Carton Wt: 75 **UPS Wt:** No UPS **COM:** N/A
Carton: 51L x 32W x 25H **Cube:** 23.61
Notes: Rated for 600 lbs. of distributed weight. Assembly required.
 ★ NJ In-Stock: -MC4 Charcoal

NEW

Fabric	Updated List Price
Coffee Finish	
-MC2 Olive	1100.00
-MC3 Navy	
-MC4 Charcoal	



★ **SL4433** Mid-Century Sofa with Coffee Finish Solid Wood Legs.
Shipped Assembled with Legs Unmounted
Overall Size: 71.5W x 31.75D x 33H
Seat: 64W x 21.25D x 5.5T
Back: 71W x 15H x 9T **Seat Height:** 18.25
Carton Wt: 93 **UPS Wt:** No UPS **COM:** N/A
Carton: 73L x 32W x 25H **Cube:** 33.79
Notes: Rated for 800 lbs. of distributed weight. Assembly required.
 ★ NJ In-Stock: -MC4 Charcoal

NEW

Fabric	Updated List Price
Coffee Finish	
-MC2 Olive	1570.00
-MC3 Navy	
-MC4 Charcoal	



★ **MUP51** Meetup Lounge Module with Chrome Legs and Ganging Hardware

Overall Size: 43W x 38D x 17H
Seat: 43W x 37.75D
Seat Height: 17
Carton Wt: 48 **UPS Wt:** 67 **COM:** 1.3 yds
Carton: 44L x 39W x 8H **Cube:** 7.9
Notes: Rated for 750 lbs. of distributed weight. UPSable, Oversized Pkg
 ★ NJ In-Stock: -R107 Dillon Black

Fabric	Updated List Price
Chrome Finish with Dillon Black (-R107) Dillon Snow (-R101)	570.00
A	600.00
B	635.00
C	670.00
R	735.00



Shown: MUP51-R107

Three Meetup Modules
Overall Dimensions: 108W x 57D



Shown in -R101 Dillon Snow



Two Meetup Modules
Overall Dimensions: 76W x 43D



★ **SL2271** Bonded Leather **BREEZE** Club Chair with Cherry Finish Legs.
Shipped Semi K/D

Overall Size: 32W x 29.5D x 32H
Seat: 20.5W x 20D
Back: 21.5W x 17H **Seat Height:** 17.75
Carton Wt: 58 **UPS Wt:** No UPS **COM:** N/A
Carton: 35L x 30W x 21H **Cube:** 12.76
Notes: Rated for 300 lbs. of distributed weight

Fabric	Updated List Price
Cherry Finish with EC3 Black EC6 Wine or EC9 Mocha Bonded Leather	840.00



★ **SL2272** Bonded Leather **BREEZE** Loveseat with Cherry Finish Legs.
Shipped Semi K/D

Overall Size: 52.5W x 29.5D x 32H
Seat: 40.5W x 20D
Back: 41W x 17H **Seat Height:** 17.75
Carton Wt: 80 **UPS Wt:** No UPS **COM:** N/A
Carton: 54L x 30W x 21H **Cube:** 19.68
Notes: Rated for 500 lbs. of distributed weight

Fabric	Updated List Price
Cherry Finish with EC3 Black EC6 Wine or EC9 Mocha Bonded Leather	1140.00



★ **SL2273** Bonded Leather **BREEZE** Sofa with Cherry Finish Legs.
Shipped Semi K/D

Overall Size: 72W x 29.5D x 32H
Seat: 60W x 20D
Back: 60.5W x 17H **Seat Height:** 17.75
Carton Wt: 105 **UPS Wt:** No UPS **COM:** N/A
Carton: 74L x 30W x 21H **Cube:** 26.97
Notes: Rated for 675 lbs. of distributed weight

Fabric	Updated List Price
Cherry Finish with EC3 Black EC6 Wine or EC9 Mocha Bonded Leather	1595.00



★ **SL2371EC9** Mocha Bonded Leather **EMBRACE** Club Chair with Cherry Finish Legs. Shipped Assembled
Overall Size: 31.5W x 29.5D x 31.5H
Seat: 20.75W x 20.25D
Back: 23.5W x 16.5H **Seat Height:** 17.75
Carton Wt: 58 **UPS Wt:** No UPS **COM:** N/A
Carton: 33L x 33W x 30H **Cube:** 18.90
Notes: Rated for 300 lbs. of distributed weight

Fabric	Updated List Price
Cherry Finish with EC9 Mocha Bonded Leather	840.00



★ **SL2372EC9** Mocha Bonded Leather **EMBRACE** Loveseat with Cherry Finish Legs. Shipped Assembled
Overall Size: 51.25W x 29.5D x 31.5H
Seat: 40.25W x 20.25D
Back: 43.5W x 16.5H **Seat Height:** 17.75
Carton Wt: 80 **UPS Wt:** No UPS **COM:** N/A
Carton: 52L x 33W x 30H **Cube:** 29.79
Notes: Rated for 500 lbs. of distributed weight

Fabric	Updated List Price
Cherry Finish with EC9 Mocha Bonded Leather	1185.00



★ **SL2373EC9** Mocha Bonded Leather **EMBRACE** Sofa with Cherry Finish Legs. Shipped Assembled
Overall Size: 70.75W x 29.5D x 31.5H
Seat: 60W x 20.25D
Back: 63.5W x 16.5H **Seat Height:** 17.75
Carton Wt: 98 **UPS Wt:** No UPS **COM:** N/A
Carton: 72L x 33W x 30H **Cube:** 41.25
Notes: Rated for 675 lbs. of distributed weight

Fabric	Updated List Price
Cherry Finish with EC9 Mocha Bonded Leather	1500.00



★ **SL2571U1** Espresso Faux Leather **PILLAR** Club Chair with Cherry Finish Legs. Shipped Assembled with Legs Unmounted
Overall Size: 33W x 31.25D x 33H
Seat: 19.5W x 20.75D
Back: 29.75W x 18.75H **Seat Height:** 19.25
Carton Wt: 72 **UPS Wt:** No UPS **COM:** N/A
Carton: 34L x 33W x 30H **Cube:** 19.47
Notes: Rated for 300 lbs. of distributed weight

Fabric	Updated List Price
Cherry Finish with U1 Espresso Faux Leather	830.00



★ **SL2572U1** Espresso Faux Leather **PILLAR** Loveseat with Cherry Finish Legs. Shipped Assembled with Legs Unmounted
Overall Size: 56.5W x 31.25D x 33H
Seat: 42W x 20.75D
Back: 52.25W x 18.75H **Seat Height:** 19.25
Carton Wt: 97 **UPS Wt:** No UPS **COM:** N/A
Carton: 57L x 33W x 30H **Cube:** 32.65
Notes: Rated for 500 lbs. of distributed weight

Fabric	Updated List Price
Cherry Finish with U1 Espresso Faux Leather	1250.00



★ **SL2573U1** Espresso Faux Leather **PILLAR** Sofa with Cherry Finish Legs. Shipped Assembled with Legs Unmounted
Overall Size: 72W x 31.25D x 33H
Seat: 59.5W x 20.75D
Back: 70.25W x 18.75H **Seat Height:** 19.25
Carton Wt: 119 **UPS Wt:** No UPS **COM:** N/A
Carton: 75L x 33W x 30H **Cube:** 42.96
Notes: Rated for 675 lbs. of distributed weight

Fabric	Updated List Price
Cherry Finish with U1 Espresso Faux Leather	1550.00



★ **SL2811** Espresso or Black Bonded Leather Club Chair with Espresso Finish Legs. Shipped K/D

Overall Size: 33W x 31.25D x 33H
Seat: 23.25W x 19.5D
Back: 23.25W x 16H **Seat Height:** 18
Carton Wt: 48 **UPS Wt:** No UPS **COM:** N/A
Carton: 33L x 31W x 21H **Cube:** 12.43
Notes: Rated for 300 lbs. of distributed weight

Fabric	Updated List Price
Espresso Finish with EC1 Espresso or EC3 Black Bonded Leather	675.00



★ **SL2812** Espresso or Black Bonded Leather Loveseat with Espresso Finish Legs. Shipped K/D

Overall Size: 56.5W x 31.25D x 33H
Seat: 46.75W x 19.5D
Back: 46.75W x 16H **Seat Height:** 18
Carton Wt: 67 **UPS Wt:** No UPS **COM:** N/A
Carton: 57L x 30W x 21H **Cube:** 20.78
Notes: Rated for 500 lbs. of distributed weight

Fabric	Updated List Price
Espresso Finish with EC1 Espresso or EC3 Black Bonded Leather	1000.00



★ **SL2813** Espresso or Black Bonded Leather Sofa with Espresso Finish Legs. Shipped K/D

Overall Size: 72W x 31.25D x 33H
Seat: 62.25W x 19.5D
Back: 62.25W x 16H **Seat Height:** 18
Carton Wt: 95 **UPS Wt:** No UPS **COM:** N/A
Carton: 64L x 33W x 25H **Cube:** 30.55
Notes: Rated for 675 lbs. of distributed weight

Fabric	Updated List Price
Espresso Finish with EC1 Espresso or EC3 Black Bonded Leather	1365.00

★ *NJ In Stock*



shown in -EC3 Black

shown:
 SL2811, SL2812 and SL2813
 in -EC1 Espresso



★ **SL2911S-U6** Black Faux Leather Club Chair with Silver Finish Legs
Shipped Assembled
Overall Size: 31.25W x 29.25D x 32H
Seat: 12.25W x 20.5D
Back: 30W x 13.75H **Seat Height:** 18.25
Carton Wt: 54 **UPS Wt:** 155 **COM:** N/A
Carton: 32L x 33W x 30H **Cube:** 18.3
Notes: Rated for 300 lbs. of distributed weight.
 UPSable, Oversized Package.

Fabric	Updated List Price
-U6 Black Faux Leather	750.00



★ **SL2912S-U6** Black Faux Leather Loveseat with Silver Finish Legs
Shipped Assembled
Overall Size: 51.5W x 29.25D x 32H
Seat: 41.5W x 20.5D
Back: 50W x 13.75H **Seat Height:** 18.25
Carton Wt: 74 **UPS Wt:** No UPS **COM:** N/A
Carton: 53L x 33W x 30H **Cube:** 30.36
Notes: Rated for 500 lbs. of distributed weight.

Fabric	Updated List Price
-U6 Black Faux Leather	1030.00



★ **SL2913S-U6** Black Faux Leather Sofa with Silver Finish Legs
Shipped Assembled
Overall Size: 69.25W x 29D x 33.25H
Seat: 60.5W x 20.5D
Back: 70W x 13.75H **Seat Height:** 18.25
Carton Wt: 92 **UPS Wt:** No UPS **COM:** N/A
Carton: 71L x 33W x 30H **Cube:** 40.67
Notes: Rated for 675 lbs. of distributed weight.

Fabric	Updated List Price
-U6 Black Faux Leather	1295.00



★ **SL4001** Black or Deluxe Pewter Bonded Leather Club Chair with Coated Silver Legs. Shipped Assembled with Legs Unmounted
Overall Size: 31.5W x 29.75D x 21H
Seat: 22W x 20.75D
Back: 28W x 17.25H **Seat Height:** 18.5
Carton Wt: 61 **UPS Wt:** 102 **COM:** N/A
Carton: 33L x 30W x 21H **Cube:** 12.03
Notes: Rated for 300 lbs. of distributed weight.
 UPSable, Oversized Package.

Fabric	Updated List Price
-EC3 Black or -BD26 Deluxe Pewter Bonded Leather	750.00

NEW



★ **SL4002** Black or Deluxe Pewter Bonded Leather Loveseat with Coated Silver Legs. Shipped Assembled with Legs Unmounted
Overall Size: 51W x 30.5D x 33.5H
Seat: 47.75W x 20.75D
Back: 47.75W x 17.25H **Seat Height:** 18.5
Carton Wt: 81 **UPS Wt:** No UPS **COM:** N/A
Carton: 52L x 30W x 21H **Cube:** 18.95
Notes: Rated for 500 lbs. of distributed weight.

Fabric	Updated List Price
-EC3 Black or -BD26 Deluxe Pewter Bonded Leather	970.00

NEW



★ **SL4003** Black or Deluxe Pewter Bonded Leather Sofa with Coated Silver Legs. Shipped Assembled with Legs Unmounted
Overall Size: 70.75W x 30.5D x 33.5H
Seat: 61W x 20.75D
Back: 67.75W x 17.25H **Seat Height:** 18.5
Carton Wt: 104 **UPS Wt:** No UPS **COM:** N/A
Carton: 71L x 30W x 21H **Cube:** 25.88
Notes: Rated for 675 lbs. of distributed weight.

Fabric	Updated List Price
-EC3 Black or -BD26 Deluxe Pewter Bonded Leather	1295.00

NEW



★ **SL8471** Black Leather Club Chair with Cherry Finish
Shipped Assembled with Legs Unmounted
Overall Size: 32W x 33.5D x 30.75H
Seat: 22W x 20D
Back: 22W x 16H **Seat Height:** 17.25
Carton Wt: 62 **UPS Wt:** No UPS **COM:** 6 yds
Carton: 34L x 33W x 30H **Cube:** 19.47
Notes: Rated for 300 lbs. of distributed weight
ANSI/BIFMA Tested

Fabric	Updated List Price
Cherry Finish Black Leather	860.00



★ **SL8472** Black Leather Loveseat with Cherry Finish
Shipped Assembled with Legs Unmounted
Overall Size: 58W x 33.5D x 30.75H
Seat: 48W x 20D
Back: 48W x 16H **Seat Height:** 17.25
Carton Wt: 91 **UPS Wt:** No UPS **COM:** 9 yds
Carton: 60L x 34W x 30H **Cube:** 35.41
Notes: Rated for 500 lbs. of distributed weight
ANSI/BIFMA Tested

Fabric	Updated List Price
Cherry Finish Black Leather	1295.00



★ **SL8473** Black Leather Sofa with Cherry Finish
Shipped Assembled with Legs Unmounted
Overall Size: 74.5W x 33.5D x 30.75H
Seat: 64W x 20D
Back: 64W x 16H **Seat Height:** 17.25
Carton Wt: 111 **UPS Wt:** No UPS **COM:** 12 yds
Carton: 79L x 34W x 30H **Cube:** 46.63
Notes: Rated for 675 lbs. of distributed weight
ANSI/BIFMA Tested

Fabric	Updated List Price
Cherry Finish Black Leather	1625.00



★ **SL9941-EC3** Black Bonded Leather Club Chair with Chrome Frame
Shipped Assembled
Overall Size: 21W x 22.5D x 26.75H
Seat: 10.75W x 22.5D
Back: 20.75W x 11.25H **Seat Height:** 17.75
Carton Wt: 66 **UPS Wt:** 157 **COM:** N/A
Carton: 35L x 33W x 28H **Cube:** 18.71
Notes: Rated for 300 lbs. of distributed weight.
 Ships Assembled. UPSable, Oversized Package.

Fabric	Updated List Price
-EC3 Black Bonded Leather	950.00

NEW



★ **SL9942-EC3** Black Bonded Leather Loveseat with Chrome Frame
Shipped Assembled
Overall Size: 41.75W x 22.5D x 26.75H
Seat: 41.75W x 22.5D
Back: 41W x 11.25H **Seat Height:** 17.75
Carton Wt: 92 **UPS Wt:** No UPS **COM:** N/A
Carton: 56L x 33W x 28H **Cube:** 29.9
Notes: Rated for 500 lbs. of distributed weight.
 Ships Assembled.

Fabric	Updated List Price
-EC3 Black Bonded Leather	1350.00

NEW



★ **SL9943-EC3** Black Bonded Leather Sofa with Chrome Frame
Shipped Assembled
Overall Size: 62.5W x 22.5D x 26.75H
Seat: 62.5W x 22.5D
Back: 63W x 11.25H **Seat Height:** 17.75
Carton Wt: 189 **UPS Wt:** No UPS **COM:** N/A
Carton: 77L x 33W x 28H **Cube:** 41.17
Notes: Rated for 675 lbs. of distributed weight.
 Ships Assembled.

Fabric	Updated List Price
-EC3 Black Bonded Leather	1795.00

NEW



★ **ACT1010** Active Perch Seat in Fabric and White Frame. Adjustable Height.

Overall Size: 15.5W x 15.5D x 24.5-34H

Seat: 15.5W x 15.5D

Seat Height: 24.5-34

Carton Wt: 17 **UPS Wt:** 21 **COM:** N/A

Carton: 17L x 17W x 15H **Cube:** 2.3

Notes: *OUTTASIGHT No-Lever Height Adjustment*

Fabric

- White Frame with
- 3 Black
- 2 Grey
- 6 Green
- 9 Red
- 18 Orange

List Price

395.00



-2 Grey



-3 Black



-6 Green



-9 Red



-18 Orange



★ **ACT1011** Active Perch Seat in Fabric and White Frame. Adjustable Height.

Overall Size: 15.5W x 15.5D x 22-31H

Seat: 15.5W x 15.5D

Seat Height: 22-31

Carton Wt: 15 **UPS Wt:** 21 **COM:** N/A

Carton: 17L x 17W x 15H **Cube:** 2.3

Notes: *OUTTASIGHT No-Lever Height Adjustment*

Fabric

- White Frame with
- 3 Black

List Price

375.00



ACT1010
Active Seating



★ **ACT3020** Active Height Adjustable Seat in Fabric.

Overall Size: 15.25W x 15.25D x 18.75-26H
Seat: 14.75W x 14.75D
Seat Height: 18.75-26
Carton Wt: 15 **UPS Wt:** 21 **COM:** N/A
Carton: 17L x 17W x 15H **Cube:** 2.3
Notes: *OUTTASIGHT No-Lever Height Adjustment*

Fabric	List Price
White Frame with -3 Black -2 Grey -6 Green -9 Red -18 Orange -512 Purple	325.00



★ **ACT4220** Active Fabric Seat with Carry Handle.

Overall Size: 16.75W x 16.75D x 18.5H
Seat: 16.75W x 16.75D
Seat Height: 18.5 Fixed
Carton Wt: 17 **UPS Wt:** 21 **COM:** N/A
Carton: 21L x 17W x 17H **Cube:** 3.51
Notes:

Fabric	List Price
-3 Black -2 Grey -6 Green -9 Red -512 Purple	275.00



★ **ACT3120** Active Height Adjustable Table.

Overall Size: 21.5W x 21.5D x 22-31.5H

Carton Wt: 26 **UPS Wt:** 28 **COM:** N/A
Carton: 24L x 24W x 10H **Cube:** 3.0
Notes: *OUTTASIGHT No-Lever Height Adjustment*

Finish	List Price
-1 White	400.00

ACT3020 in Multiple Colors



ACT4220 in Multiple Colors



★ **519117HC-EC3** High Mesh Back and Bonded Leather Seat Manager's Chair with Padded Polished Aluminum Arms and Chrome Base

Overall Size: 24W x 23.5D x 43H
Seat: 20.5W x 20.5D x 3.5T **Back:** 19.25W x 25.5H **Seat Range:** 17.5-21.25
Arms to Floor: 25.5 **Carton Wt:** 42 **UPS Wt:** 43 **COM:** N/A
Carton: 28L x 26W x 12H **Cube:** 5.05
Options: SW392 **Features:** 1, 4, 7, 8, 9 **Control:** 2 to 1 Synchro Tilt
Notes: Bonded Leather Durability-Tested to 100K Double Rubs.

Fabric	Updated List Price
-EC3 Black Bonded Leather	560.00



51911HC-EC3 High Mesh Back and Bonded Leather Seat Manager's Chair with Chrome Base

Overall Size: 24W x 23.5D x 43H
Seat: 20.5W x 20.5D x 3.5T **Back:** 19.25W x 25.5H **Seat Range:** 17.5-21.25
Arms to Floor: N/A **Carton Wt:** 42 **UPS Wt:** 54 **COM:** N/A
Carton: 28L x 26W x 15H **Cube:** 6.31
Options: SW392 **Features:** 1, 4, 7, 8, 9 **Control:** 2 to 1 Synchro Tilt
Notes: Bonded Leather Durability-Tested to 100K Double Rubs.

Fabric	Updated List Price
-EC3 Black Bonded Leather	500.00



★ **519117MC-EC3** Mid Mesh Back and Bonded Leather Seat Manager's Chair with Padded Polished Aluminum Arms and Chrome Base

Overall Size: 23W x 23D x 38H
Seat: 20.5W x 20.5D x 3.5T **Back:** 19.5W x 20.5H **Seat Range:** 17.5-21.25
Arms to Floor: 25.5 **Carton Wt:** 40 **UPS Wt:** 40 **COM:** N/A
Carton: 24L x 24W x 13H **Cube:** 4.33
Options: SW392 **Features:** 1, 4, 7, 8, 9 **Control:** 2 to 1 Synchro Tilt
Notes: Bonded Leather Durability-Tested to 100K Double Rubs.

Fabric	Updated List Price
-EC3 Black Bonded Leather	525.00



51911MC-EC3 Mid Mesh Back and Bonded Leather Seat Manager's Chair with Chrome Base

Overall Size: 20.25W x 23.75D x 34-37.5H
Seat: 20.25W x 20D x 3T **Back:** 19.5W x 17H **Seat Range:** 17.75-21.25
Arms to Floor: N/A **Carton Wt:** 40 **UPS Wt:** 40 **COM:** N/A
Carton: 24L x 24W x 12H **Cube:** 4.0
Options: SW392 **Features:** 1, 4, 7, 8, 9 **Control:** 2 to 1 Synchro Tilt
Notes: Bonded Leather Durability-Tested to 100K Double Rubs.

Fabric	Updated List Price
-EC3 Black Bonded Leather	475.00



★ **518317HA-EC3** Black Bonded Leather Manager's Chair with Padded Polished Aluminum Arms and Base

Overall Size: 22.5W x 23.75D x 42.5H
Seat: 20.5W x 20.5D x 3.5T **Back:** 18.75W x 27.25H x 3T **Seat Range:** 18.5-22
Arms to Floor: 25.5 **Carton Wt:** 45 **UPS Wt:** 43 **COM:** N/A
Carton: 28L x 26W x 12H **Cube:** 5.05
Options: SW392 **Features:** 1, 4, 7, 8, 9 **Control:** 2 to 1 Synchro Tilt Control
Notes: Bonded Leather Durability-Tested to 100K Double Rubs.

Fabric	Updated List Price
-EC3 Black Bonded Leather	575.00



51831HA-EC3 Black Bonded Leather Manager's Chair with Aluminum Base

Overall Size: 20.25W x 25D x 40-43.5H
Seat: 20W x 19.25D x 3T **Back:** 18.75W x 22.25H x 2.25T **Seat Range:** 18.5-22
Arms to Floor: N/A **Carton Wt:** 43 **UPS Wt:** 43 **COM:** N/A
Carton: 28L x 26W x 12H **Cube:** 5.05
Options: SW392 **Features:** 1, 4, 7, 8, 9 **Control:** 2 to 1 Synchro Tilt Control
Notes: Bonded Leather Durability-Tested to 100K Double Rubs.

Fabric	Updated List Price
-EC3 Black Bonded Leather	525.00

Options



★ **SW392 Soft Wheel Caster (set of 5)**

🌿 **Carton Wt:** 2 **Cube:** 0.2

Designed For: Angled Base Chairs
 See Individual Chair Options

Updated List: 32.00 (set of 5)



NAP91CHY/ESP/MAH/MPL Napa Guest Chair with Wood Back (1 pack)

Overall Size: 22.5W x 21.75D x 30.75H
Seat: 22W x 18D x 3T **Back:** 20W x 7.5H **Seat Range:** 19 Fixed
Arms to Floor: 25.5 **Carton Wt:** 29 **UPS Wt:** 39 **COM:** .75 yds
Carton: 34L x 26W x 9H **Cube:** 4.6 **Pack:** 1
Notes: Ships 1 per carton. Assembly Required.
Notes: KD Construction
 Napa Casegoods on Pages 73-79

Fabric	Updated List Price
-3 Black	445.00
A	468.00
B	495.00
C	500.00
R	550.00

NAP91



CHY - Cherry
★



ESP - Espresso ★



MAH - Mahogany ★



MPL - Maple ★



NAP95CHY/ESP/MAH/MPL Napa Guest Chair with Upholstered Back (1 pack)

Overall Size: 22.5W x 22D x 31H
Seat: 22W x 18.5D x 3T **Back:** 20W x 8H x 2T **Seat Range:** 19 Fixed
Arms to Floor: 25.5 **Carton Wt:** 29 **UPS Wt:** 38 **COM:** 1.0 yds
Carton: 34L x 25W x 9H **Cube:** 3.12 **Pack:** 1
Notes: Ships 1 per carton. Assembly Required.
Notes: KD Construction
 Napa Casegoods on Pages 73-79

Fabric	Updated List Price
-3 Black or -EC3 Black Bonded Leather	445.00
A	468.00
B	495.00
C	520.00
R	550.00

NAP95



CHY - Cherry
★



ESP - Espresso ★



MAH - Mahogany ★



MPL - Maple ★



NAP97CHY/ESP/MAH/MPL Napa Guest Chair with Full Cushion Back (1 pack)

Overall Size: 23W x 23.5D x 32.75H
Seat: 22W x 17.5D x 3T **Back:** 19W x 14H x 1.5T **Seat Range:** 19 Fixed
Arms to Floor: 27 **Carton Wt:** 29 **UPS Wt:** 47 **COM:** 1.5 yds.
Carton: 36L x 24W x 11H **Cube:** 5.5 **Pack:** 1
Notes: Ships 1 per carton. Assembly Required.
Notes: KD Construction
 Napa Casegoods on Pages 73-79

Fabric	Updated List Price
-EC3 Black Bonded Leather	480.00
A	510.00
B	538.00
C	566.00
R	595.00

NAP97



CHY - Cherry
★



ESP - Espresso ★



MAH - Mahogany ★



MPL - Maple ★



★ **KEN-992-MAH/KEN-992-LCH** Leg Chair with Wood Slat Back & Mahogany or Light Cherry Finish (2-Pack)

Overall Size: 23W x 23D x 32H

Seat: 20W x 18.5D **Back:** 18.5W x 15.5H **Seat Range:** 19 Fixed

Arms to Floor: 27 **Carton Wt:** 48 **UPS Wt:** No UPS **COM:** 1 yd per Chair

Carton: 42L x 33W x 26H **Cube:** 20.85 **Pack:** 2

Notes: Ships 2 per Carton, Frame Fully Assembled, Seat Cushions Unmounted

Notes:

Kenwood Casegoods on Pages 55-57

Fabric	Updated List Price
	2-Pack
Black	798.00
A	840.00
B	885.00
C	932.00
R	982.00



★ **KEN-99-MAH/KEN-99-LCH** Leg Chair with Wood Slat Back & Mahogany or Light Cherry Finish (4-Pack)

Overall Size: 23W x 23D x 32H

Seat: 20W x 18.5D **Back:** 18.5W x 15.5H **Seat Range:** 19 Fixed

Arms to Floor: 27 **Carton Wt:** 90 **UPS Wt:** No UPS **COM:** 1 yd per Chair

Carton: 44L x 34W x 26H **Cube:** 22.50 **Pack:** 4

Notes: Ships 4 per Carton, Frame Fully Assembled, Seat Cushions Unmounted

Notes:

Kenwood Casegoods on Pages 55-57

Fabric	Updated List Price
	4-Pack
Black	1600.00
A	1684.00
B	1773.00
C	1866.00
R	1964.00



★ **KEN-1292-MAH/KEN-1292-LCH** Leg Chair with Upholstered Back & Mahogany or Light Cherry Finish (2-Pack)

Overall Size: 23W x 23D x 32H

Seat: 20W x 18.5D **Back:** 18.5W x 15.5H **Seat Range:** 19 Fixed

Arms to Floor: 27 **Carton Wt:** 50 **UPS Wt:** No UPS **COM:** 1.5 yd per Chair

Carton: 39L x 28W x 25H **Cube:** 15.79 **Pack:** 2

Notes: Ships 2 per Carton, Frame Fully Assembled, Seat Cushions Unmounted

Notes:

Kenwood Casegoods on Pages 55-57

Fabric	Updated List Price
	2-Pack
Black	798.00
A	840.00
B	885.00
C	932.00
R	982.00



★ **KEN-129-MAH/KEN-129-LCH** Leg Chair with Upholstered Back & Mahogany or Light Cherry Finish (4-Pack)

Overall Size: 23W x 23D x 32H

Seat: 20W x 18.5D **Back:** 18.5W x 15.5H **Seat Range:** 19 Fixed

Arms to Floor: 27 **Carton Wt:** 95 **UPS Wt:** No UPS **COM:** 1.5 yd per Chair

Carton: 44L x 35W x 26H **Cube:** 23.17 **Pack:** 4

Notes: Ships 4 per Carton, Frame Fully Assembled, Seat Cushions Unmounted

Notes:

Kenwood Casegoods on Pages 55-57

Fabric	Updated List Price
	4-Pack
Black	1600.00
A	1684.00
B	1773.00
C	1866.00
R	1964.00

Finish Key

MAH = Mahogany Finish
CHY = Cherry Finish

LCH = Light Cherry Finish

ESP = Espresso Finish



★ *NJ In Stock*



Shown in Dillon Fabrics
KEN99MAH-R101 and KEN129MAH-R101



★ **SON-992-CHY** Leg Chair with Wood Slat Back & Sonoma Cherry Finish (2-Pack)

Overall Size: 23W x 23D x 32H
Seat: 20W x 18.5D **Back:** 18.5W x 15.5H **Seat Range:** 19 Fixed
Arms to Floor: 27 **Carton Wt:** 48 **UPS Wt:** No UPS **COM:** 1 yd per Chair
Carton: 39L x 28W x 25H **Cube:** 15.79 **Pack:** 2
Notes: Ships 2 per Carton, Frame Fully Assembled, Seat Cushions Unmounted
Notes:
 Sonoma Casegoods on Pages 58-60

Fabric	Updated List Price
	2-Pack
Black	798.00
A	840.00
B	885.00
C	932.00
R	982.00



★ **SON-99-CHY** Leg Chair with Wood Slat Back & Sonoma Cherry Finish (4-Pack)

Overall Size: 23W x 23D x 32H
Seat: 20W x 18.5D **Back:** 18.5W x 15.5H **Seat Range:** 19 Fixed
Arms to Floor: 27 **Carton Wt:** 92 **UPS Wt:** No UPS **COM:** 1 yd per Chair
Carton: 44L x 34W x 26H **Cube:** 22.50 **Pack:** 4
Notes: Ships 4 per Carton, Frame Fully Assembled, Seat Cushions Unmounted
Notes:
 Sonoma Casegoods on Pages 58-60

Fabric	Updated List Price
	4-Pack
Black	1600.00
A	1684.00
B	1773.00
C	1866.00
R	1964.00



★ **SON-1292-CHY** Leg Chair with Upholstered Back & Sonoma Cherry Finish (2-Pack)

Overall Size: 23W x 23D x 32H
Seat: 20W x 18.5D **Back:** 18.5W x 15.5H **Seat Range:** 19 Fixed
Arms to Floor: 27 **Carton Wt:** 48 **UPS Wt:** No UPS **COM:** 1.5 yd per Chair
Carton: 39L x 28W x 25H **Cube:** 15.79 **Pack:** 2
Notes: Ships 2 per Carton, Frame Fully Assembled, Seat Cushions Unmounted
Notes:
 Sonoma Casegoods on Pages 58-60

Fabric	Updated List Price
	2-Pack
Black	798.00
A	840.00
B	885.00
C	932.00
R	982.00



★ **SON-129-CHY** Leg Chair with Upholstered Back & Sonoma Cherry Finish (4-Pack)

Overall Size: 23W x 23D x 32H
Seat: 20W x 18.5D **Back:** 18.5W x 15.5H **Seat Range:** 19 Fixed
Arms to Floor: 27 **Carton Wt:** 94 **UPS Wt:** No UPS **COM:** 1.5 yd per Chair
Carton: 43L x 35W x 26H **Cube:** 22.64 **Pack:** 4
Notes: Ships 4 per Carton, Frame Fully Assembled, Seat Cushions Unmounted
Notes:
 Sonoma Casegoods on Pages 58-60

Fabric	Updated List Price
	4-Pack
Black	1600.00
A	1684.00
B	1773.00
C	1866.00
R	1964.00



Finish Key

MAH = Mahogany Finish
CHY = Cherry Finish

LCH = Light Cherry Finish

ESP = Espresso Finish

★ *NJ In Stock*

SIS

Systems In Stock



SIS offers full-featured, contract-quality systems furniture backed by a limited lifetime warranty.

- Recyclable metal materials
- Powdercoat finishes
- Re-usable metal-to-metal connections
- Glass panels with real glass
- Strong core construction
- Meets ANSI/BIFMA
- UL approved, including electrical and fabric
- 100% polyester UL-recognized (UR) fabric
- Installer-friendly, rod-and-block assembly
- IN STOCK



Create open environments to private workstations with 39", 53", 53" glass and 67" panel heights

14' x 5' Shared Workstation
 White finish & Urban Walnut worksurfaces
 39"H Panels
 20"D Mobile Pedestals

22"D Pedestals also available
 30" & 36" wide lateral files also available



SIS electrical is designed specifically for the system and is both UL Listed and CSA Certified. It is an 8-wire, 4-circuit system with 3 open, 1 dedicated circuit to support any power/data requirements. Power can run through panels and connectors. Ceiling and base feeds are available. The flush-design, black raceways feature steel bases, scratch-resistant resin covers and adjustable glides.

Worksurfaces



WHT
White

URB
Urban Walnut

ESP
Espresso

Fabric



O1
Drift

Finishes

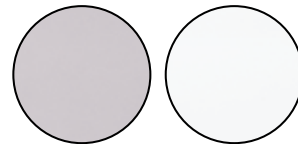

SV
Silver

WH
White



**Telemarketing Station
2-Pack 8' x 2.5'**
Silver finish & Espresso
worksurfaces
67"H Panels with Locking
Overheads
LED Lighting
20"D Mobile Pedestals

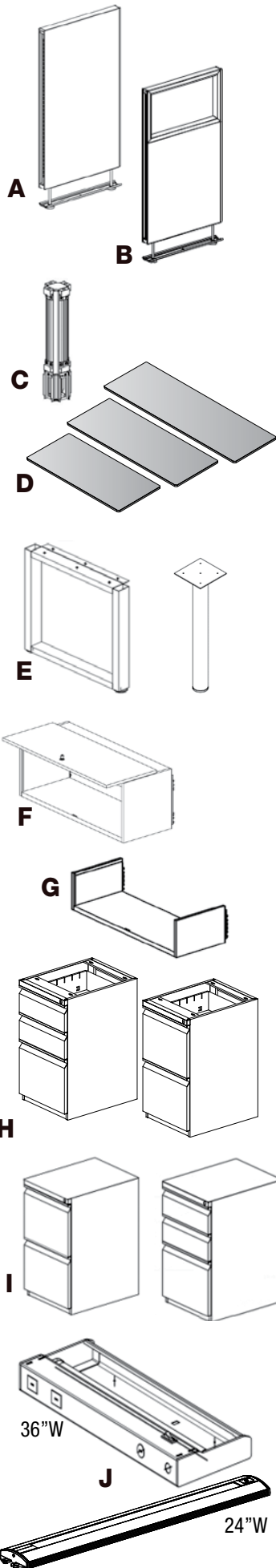

A. Panels - Fabric

67H x 24W	53H x 24W	39H x 24W
67H x 30W	53H x 30W	39H x 30W
67H x 36W	53H x 36W	39H x 36W
67H x 42W	53H x 42W	39H x 42W
67H x 48W	53H x 48W	39H x 48W

** Raceway covers, end caps and draw rods specified separately

B. Panels - Fabric + Glass

53H x 24W	53H x 42W
53H x 30W	53H x 48W
53H x 36W	

** Non-powered and powered panels available

C. Connectors - 67, 53 & 39 Heights

2-way
3-way
4-way

D. Worksurfaces

72W x 24D
66W x 24D
60W x 24D
48W x 24D
42W x 24D
36W x 24D
30W x 24D

Transaction Counters

72W x 14D
60W x 14D

Transaction Counter Brackets

End Bracket
Middle Bracket
Panel/Connector Bracket
Panel/Panel Bracket

E. Worksurface Support Legs

24"D 0 Leg
24"D Single Peninsula Leg

A full selection of panel-hung, worksurface supporting Hardware is available

F. Metal Overhead Storage with Locking Flipper Door

24", 30", 36", 42" & 48" widths

G. Metal Hanging Shelf

24", 30", 36", 42" & 48" widths

H. Worksurface Supporting Pedestals (Open Top)

20"D Box/Box/File
20"D File/File

I. Mobile Pedestals (Closed Top)

20"D Box/Box/File	20"D File/File	20"D Box/File
22"D Box/Box/File	22"D File/File	

J. Task Lighting

24"W LED Task Light (connectable)
24"W Motion LED Task Light (connectable)

36"W Incandescent Task Light

** Motion sensor for auto on/off...power savings

K. Panel - Top Frosted Glass

Privacy Screens with Mounting Brackets
24", 30", 36", 42" & 48" widths

Electrical SIS features an 8-wire, 4-circuit electrical system with base and ceiling feeds, power pole for full power/data capability. Electrical is UL Listed and CSA Certified.

SYSTEMS IN STOCK



Silver Finish & White Worksurfaces

Pricing shown is without electrical

Complete UL approved 8-wire, 4-circuit electrical system also in stock
 Panels can be shipped non-powered or powered

6 x 6 x 39H	w/1 Pedestal	w/2 Pedestals
1 Office	\$4,602 List	\$5,197 List
3-Pack	\$12,766 List	\$14,551 List

Unique system

Sleek, rectilinear design and flush style base

Modern colors

IN STOCK
New Jersey

FREE drawing and specification services



White Finish & White Worksurfaces

5 x 5 x 53H	w/1 Pedestal	w/2 Pedestals
1 Office	\$4,734 List	\$5,329 List
6-Pack	\$22,249 List	\$25,819 List



Silver Finish & White Worksurfaces

Worksurface, finish and fabric swatches shown on page 51

6 x 6 x 67H & 53H	w/1 Pedestal	36W Overhead	LED Lighting	2nd Pedestal
1 Office	\$5,365 List	\$440 List	\$300 List	\$595 List
3-Pack	\$14,965 List			

SYSTEMS IN STOCK



NEW! Tuxedo in
in Slate Grey
See pages 69-72



NAP-36-URB in Urban Walnut
See page 77

CASEGOODS



PHAT Tables
Adjustable-Height
See pages 92-94



Kenwood features fluted hardwood edge design and select hardwood veneers. Each is book-matched and assembled in traditional fashion to develop the natural grain character. Complementing this careful craftsmanship are a warm Light Cherry, Mahogany and new Espresso finishes. Durable finishes feature subtle sheen created through multiple-step processes to achieve a unique level of sophistication. New glass modesty panels and glass door hutch add modern styling.

Finish Key

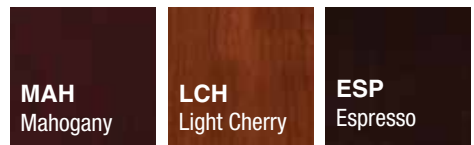

DESKS

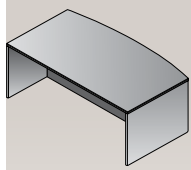

KEN-89-xxx
Bow Desk Shell
72"x39"x29"
CU:8.9 WT:191.8
List Price: **\$1905**

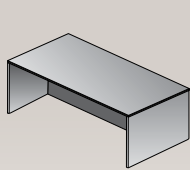

KEN-01-xxx
Desk Shell
72"x36"x29"
CU:6.8 WT:176.4
List Price: **\$1815**

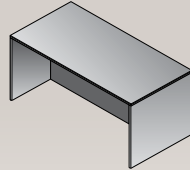

KEN-02-xxx
Desk Shell
66"x30"x29"
CU:5.3 WT:136.7
List Price: **\$1530**

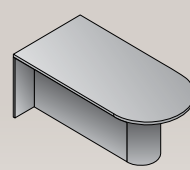

KENxxx-47
Bullet
72"x36"x29"
CU:9.7 WT:149.9
Consists of:
KEN-47T, KEN-41/47B
Not Available in Espresso
List Price: **\$1690**

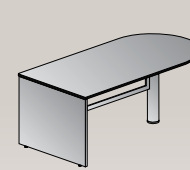

KENxxx-47GM
Bullet Desk w/Glass
1/2 Modesty Panel
72"x36"x29"
CU:8.7 WT:138.9
Consists of: KEN-47TGM, 41/47PSLVR
List Price: **\$1850**

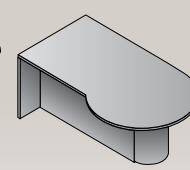

KENxxx-41L
Left P-Top
72"x36"/42"x29"
CU:10.9 WT:154.3
Consists of: KEN-41TL, 41/47B
Not Available in Espresso
List Price: **\$950**
Phase Out

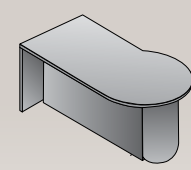

KENxxx-41R
Right P-Top
72"x36"/42"x29"
CU:10.9 WT:154.3
Consists of: KEN-41TR, 41/47B
Not Available in Espresso
List Price: **\$950**
Phase Out

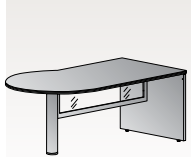

KENxxx-41LGM
Left P-Top w/Glass
1/2 Modesty Panel
72"x36"/42"x29"
CU:9.5 WT:138.9
Consists of: KEN-41TLGM, 41/47P-SLVR
Not Available in Espresso
List Price: **\$995**
Phase Out

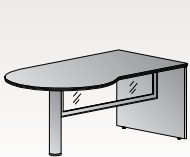

KENxxx-41RGM
Right P-Top w/Glass
1/2 Modesty Panel
72"x36"/42"x29"
CU:9.5 WT:138.9
Consists of: KEN-41TRGM, 41/47P-SLVR
Not Available in Espresso
List Price: **\$995**
Phase Out

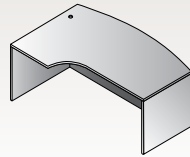

KEN-87L-xxx
Left Corner Bow
Desk
72"x30"/48"x29"
CU:9.3 WT:175.3
Not Available in Espresso
List Price: **\$2130**

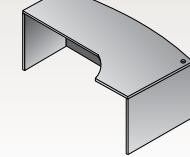

KEN-87R-xxx
Right Corner Bow
Desk
72"x30"/48"x29"
CU:9.3 WT:175.3
Not Available in Espresso
List Price: **\$2130**

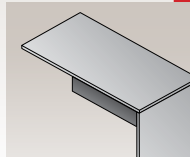

KEN-45-xxx
Return Shell
48"x24"x29"
CU:3.6 WT:79.4
List Price: **\$920**

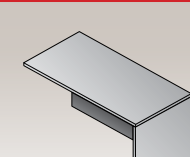

KEN-96-xxx
Return
42"x24"x29"
CU:3.2 WT:72.8
List Price: **\$805**

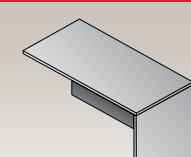

KEN-92-xxx
Return Shell
36"x24"x29"
CU:2.8 WT:77.2
Not Available in Espresso
List Price: **\$730**

RETURNS

BRIDGES

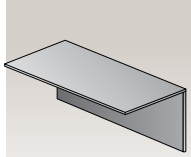

KEN-70-xxx
Bridge Shell
48"x24"x29"
CU:2.8 WT:66.1
List Price: **\$740**

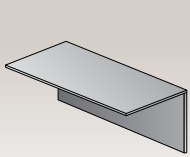

KEN-98-xxx
Bridge
42"x24"x29"
CU:2.6 WT:55.1
List Price: **\$640**

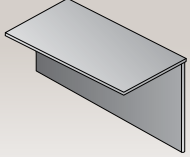

KEN-93-xxx
Bridge
36"x24"x29"
CU:2.3 WT:46.3
Not Available in Espresso
List Price: **\$580**

CREDENZAS

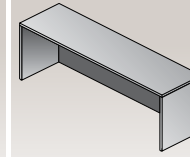

KEN-43-xxx
Credenza Shell
72"x20"x29"
CU:5.1 WT:119.0
List Price: **\$1270**

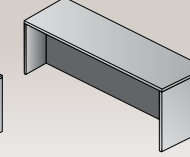

KEN-11-xxx
Credenza Shell
66"x20"x29"
CU:4.7 WT:103.6
List Price: **\$1210**
Not Available in Espresso

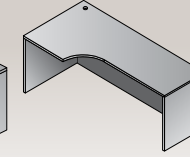

KEN-82L-xxx
Left Corner
Credenza
72"x36"x29"
CU:7.1 WT:145.5
Not Available in Espresso
List Price: **\$800**
Phase Out

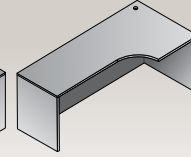

KEN-82R-xxx
Right Corner
Credenza
72"x36"x29"
CU:7.1 WT:145.5
Not Available in Espresso
List Price: **\$800**
Phase Out

PEDESTALS

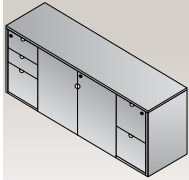

KEN-10-xxx
Storage Credenza
72"x20"x29"
CU:26.8 WT:251.3
List Price: \$3050
Ships Assembled

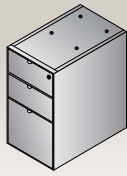

KEN-65-xxx
BBF Ped-Desk
24.25"x15.5"x27"
CU:7.4 WT:72.8
List Price: \$890
Ships Assembled

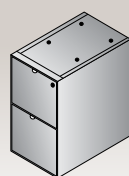

KEN-74-xxx
FF Ped-Desk
24.25"x15.5"x27"
CU:7.4 WT:69.4
List Price: \$890
Ships Assembled

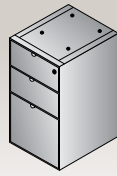

KEN-66-xxx
BBF Ped-Credenza/
Return
18.5"x15.5"x27"
CU:5.7 WT:59.5
List Price: \$740
Ships Assembled

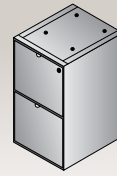

KEN-75-xxx
FF Ped-Credenza/
Return
18.5"x15.5"x27"
CU:5.7 WT:56.2
List Price: \$740
Ships Assembled

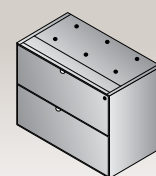

KEN-68-xxx
Lateral File Ped
35"x18"x27"
CU:12.2 WT:97
List Price: \$1555
Ships Assembled

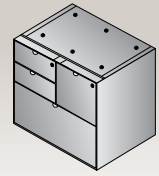

KEN-69-xxx
MultiFile Ped
32"x18"x27"
CU:11.2 WT:93.7
Not Available in LCH
List Price: \$1845
Ships Assembled

ACCESSORIES

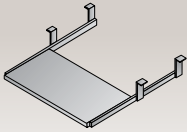

KEN-14-xxx
Keyboard Tray
26"x12"
CU:0.6 WT:11.0
List Price: \$135

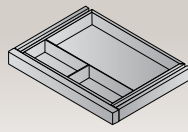

KEN-15-xxx
Center Drawer
15"x20"
CU:0.7 WT:7.7
List Price: \$110

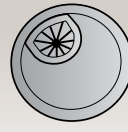

NAP-GM
Metallic Grommets (5-Pack)
2.5"x2.5"x1"
CU:0.02 WT:0.05
List Price: \$95



LK1-GC
Lock Core with Keys
\$15 List
KC-GC Change Key
\$8 List
KM-GC Master Key
\$8 List

HUTCHES

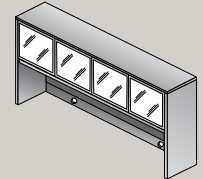

KENxxx-42
Overhead with Glass
Doors
72" x 14" x 42"
CU:8.8 WT:165.4
Consists of: KEN-
44H, 4DG
List Price: \$1945

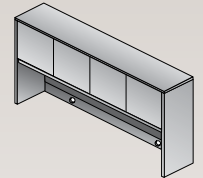

KENxxx-44
Overhead Storage
72"x14"x42"
CU:8.8 WT:165.4
Consists of: KEN-
44H, 4DW
List Price: \$1945

STORAGE & FILING

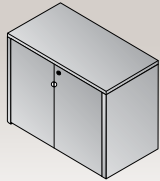

KEN-13-xxx
Storage Cabinet
37"x20"x29"
CU:5.3 WT:110.2
List Price: \$1500

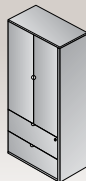

KEN-52-xxx
Storage/Lateral File
37.5"x20"x71"
CU:35.2 WT:147.7
Not Available in Espresso
List Price: \$4115
Ships Assembled

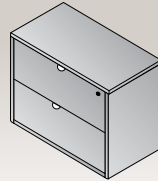

KEN-12-xxx
Lateral File
37"x20"x29"
CU:14.1 WT:143.1
List Price: \$1715
Ships Assembled



KEN-51-xxx
Wardrobe/Storage
37.5"x20"x71"
CU:10.9 WT:194
Not Available in Espresso
List Price: \$3230

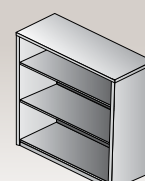

KEN-55-xxx
Bookcase/Open
Hutch
36"x14"x42"
CU:4.8 WT:103.6
List Price: \$1100

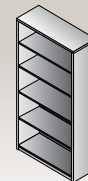

KEN-56-xxx
5-Shelf Bookcase
36"x14"x71"
CU:7.5 WT:165.3
List Price: \$1690

RECEPTION

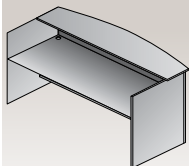

KEN-122-xxx
Reception Desk
72"x30"x42"
CU:9.6 WT:242.5
List Price: \$2580

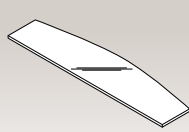

NAP-123
Glass Floating Top
Fits KEN122
71"x17.5"x0.5"
CU:2.1 WT:79.4
List Price: \$495

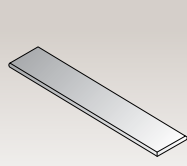

KEN-124-xxx
Counter (for return
#125)
60"x12.5"
CU:1.5 WT:23.8
List Price: \$375

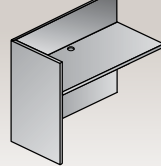

KEN-125-xxx
Reception Return
42"x20"x42"
CU:4.0 WT:92.6
List Price: \$1020

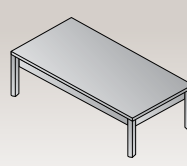

KEN-19-xxx
Coffee Table
48"x24"x16"
CU:4.0 WT:61.7
List Price: \$890

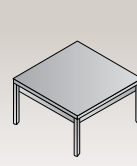

KEN-20-xxx
End Table
24"x24"x20"
CU:2.1 WT:41.9
List Price: \$615

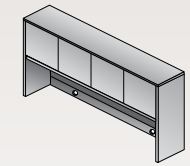

KEN-39-xxx
Overhead Storage
with Wood Doors
66"x14"x42"
CU:7.6 WT:152.8
Not Available in Espresso
List Price: \$995

CONFERENCE

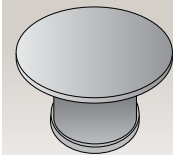

KENxxx-58
RoundTable
42"Dia.x30"H
CU:11.2 WT:97
Consists of:
KEN-58T, 58B
List Price: \$1435

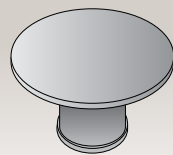

KENxxx-59
RoundTable
48"Dia.x30"H
CU:15.2 WT:106.9
Consists of:
KEN-59T, 59/63B
List Price: \$1690

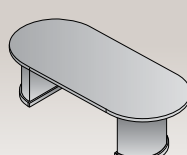

KENxxx-35
Conference Table
72"x36"x30"
CU:13.9 WT:185
Consists of: KEN-
35T/S, 35B
List Price: \$2160
Not Available in Espresso

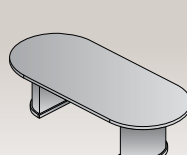

KENxxx-60
Conference Table
96"x42"x30"
CU:21.5 WT:201
Consists of: KEN-
60T/S, 60/61/62B
List Price: \$2445

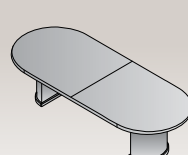

KENxxx-61
Conference Table
120"x48"x30"
CU:21.1 WT:271.1
Consists of: KEN-
61T, 61S, 60/61/62B
List Price: \$3445

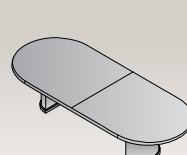

KENxxx-62
Conference Table
144"x48"x30"
CU:23.1 WT:306.5
Consists of: KEN-
62T, 62S, 60/61/62B
List Price: \$4185

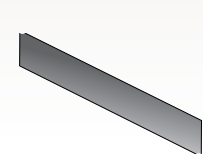

NAPT B-3
Tackboard for NAP42/44
SON44, KEN42/44
65"x17.5"
Black Fabric
CU:1.2 WT:15
List Price: \$195

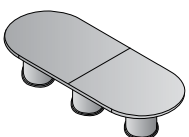

KENxxx-63
Conference Table
168"x48"x30"
CU:44 WT:387
Consists of: KEN-
63T, 59/63B(3 qty.)
List Price: \$5505

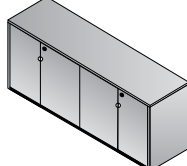

KEN-50-xxx
4 Door Credenza
72"x20"x29"
CU:9.4 WT:200.6
List Price: \$2355

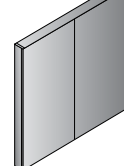

KEN-100-xxx
Presentation Board
48"x48"x4"
CU:8.8 WT:110.2
List Price: \$1720
Ships Assembled

Tackboard
Custom Fabric
NAPT B____
(Specify Fabric)
Grade A \$250
Grade B \$280
Grade C \$310
Grade R \$340

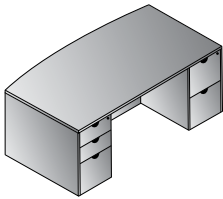

Bow Top Desk 72"x39"
KENxxx-TYP1
 23.7 cu. ft. 334 lbs.
 Consists of: KEN-89,65,74
\$3,685

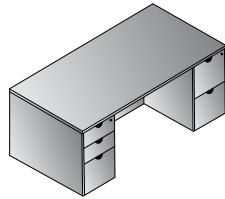

Double Pedestal Desk 72"x36"
KENxxx-TYP2
 21.6 cu. ft. 318.6 lbs.
 Consists of: KEN-01,65,74
\$3,595

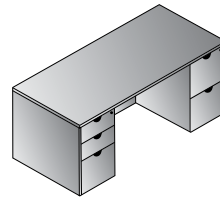

Double Pedestal Desk 66"x30"
KENxxx-TYP3
 20.1 cu. ft. 278.9 lbs.
 Consists of: KEN-02,65,74
\$3,310

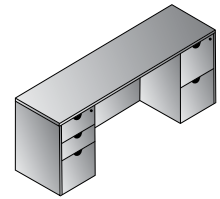

Kneespace Credenza 72"x20"
KENxxx-TYP5
 16.5 cu. ft. 234.7 lbs.
 Consists of: KEN-43,66,75
\$2,750

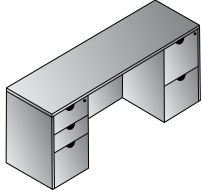

Kneespace Credenza 66"x20"
KENxxx-TYP6
 16.1 cu. ft. 219.3 lbs.
 Consists of: KEN-11,66,75
\$2,690

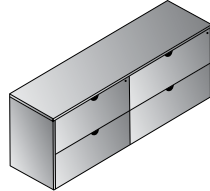

Double Lateral File Credenza 72"x20"
KENxxx-TYP7
 29.3 cu. ft. 313.0 lbs.
 Consists of: KEN-43,68,68
\$4,380

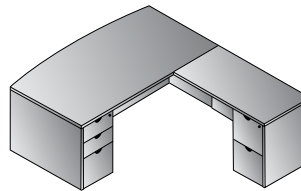

L Shape w/Bow Desk 72"x87"
KENxxx-TYP8
 25.6 cu. ft. 400.2 lbs.
 Consists of: KEN-89,65,45,75
\$4,455

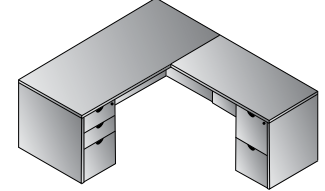

L Shape 66"x78"
KENxxx-TYP9
 22.0 cu. ft. 345.1 lbs.
 Consists of: KEN-02,65,45,75
\$4,080

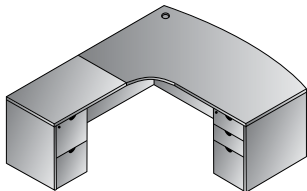

Left L Shape w/Curved Corner 72"x82"
KENxxx-TYP10L
 25.2 cu. ft. 381.5 lbs.
 Consists of: KEN-87L,65,92,75
Not Available in Espresso
\$4,490

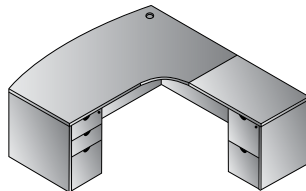

Right L Shape w/Curved Corner 72"x82"
KENxxx-TYP10R
 25.2 cu. ft. 381.5 lbs.
 Consists of: KEN-87R,65,92,75
Not Available in Espresso
\$4,490

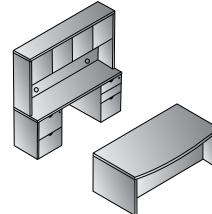

Executive Office 72"x82"
KENxxx-TYP11
 49 cu. ft. 734.1 lbs.
 Consists of: KEN-89,65,74,43, 66,75,44
 KEN44 Consists of: KEN-44H,4DW
\$8,380

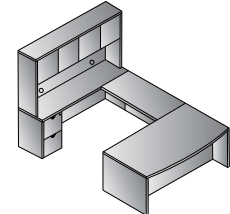

U Shape w/Hutch 72"x107"
KENxxx-TYP12
 38.7 cu. ft. 671.3 lbs.
 Consists of: KEN-89,65,70, 43,75,44
 KEN44 consists of: KEN-44H,4DW
\$7,490

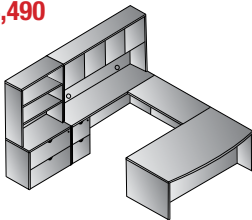

U w/Hutch + Storage 108"x107"
KENxxx-TYP13
 57.6 cu. ft. 918 lbs.
 Consists of: KEN-89,65,70,43,75,44,12,55
 KEN44 consists of: KEN-44H,4DW
\$10,305

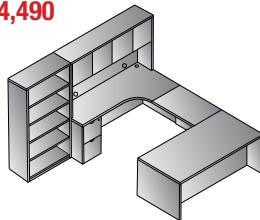

Left U + Bookcase 108"x108"
KENxxx-TYP14L
 46.5 cu. ft. 827.9 lbs.
 Consists of: KEN-01,65,93,82R,75,44,56
 KEN44 consists of: KEN-44H,4DW
\$8,460

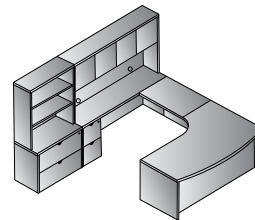

Left U w/Corner + Storage 108"x102"
KENxxx-TYP15L
 57.5 cu. ft. 881.7 lbs.
 Consists of: KEN-87L,65,93,43,75,44,12,55
 KEN44 consists of: KEN-44H,4DW
Not Available in Espresso
\$10,370

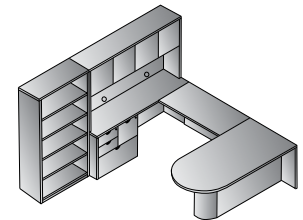

U w/Bullet + Bookcase 108"x104"
KENxxx-TYP16
 44.1 cu. ft. 748.4 lbs.
 Consists of: KEN-47,70,43,69,44,56
 KEN44 consists of: KEN-44H,4DW
 KEN47 consists of: KEN-47T,41/47B
Not Available in Espresso
\$9,180

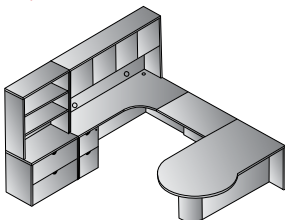

Left U w/P-Top + Storage 108"x114"
KENxxx-TYP17L
 53.7 cu. ft. 814.4 lbs.
 Consists of: KEN-41R,93,82R, 75,44,12,55
 KEN44 consists of: KEN-44H,4DW
 KEN41R consists of: KEN-41TR,41/47B
Not Available in Espresso
\$7,830

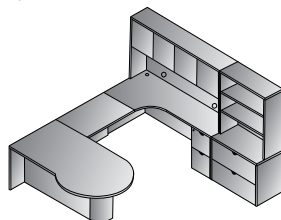

Right U w/P-Top + Storage 108"x114"
KENxxx-TYP17R
 53.7 cu. ft. 814.4 lbs.
 Consists of: KEN-41L,93,82L, 75,44,12,55
 KEN44 consists of: KEN-44H,4DW
 KEN41L consists of: KEN-41TL,41/47B
Not Available in Espresso
\$7,830

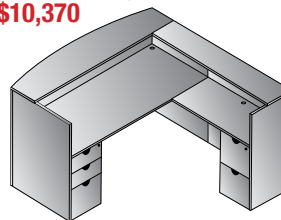

Reception Station 72"x72"x43"H
KENxxx-TYP19
 28.2 cu. ft. 487.9 lbs.
 Consists of: KEN-122,65,125,75,124
\$5,605



Conference Group 3-Pcs.
KENxxx-TYP20
 35.6 cu. ft. 421 lbs.
 Consists of: KEN-60,13,100
 KEN60 consists of: KEN-60T/S,60/61/62B
\$5,665

Our most extensive offering, Sonoma complements contemporary environments with soft radius edges, compound-curved corners and several curved components, such as P-Tops, half-cylinder table bases, round and racetrack tables. All conference tables feature 2" thick tops. Work surfaces and end panels are 1-1/8" thick. Edges and corners are solid hardwood carefully crafted to match select hardwood veneers, presented in Dark Cherry stain. Medium sheen finishes from multiple-step processes provide executive appearance and lasting durability.



Finish Key
CHY - Dark Cherry



CREDENZAS

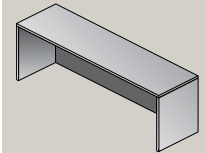

SON-43
Credenza Shell
72"x20"x29"
CU:5.6 WT:121.3
List Price: **\$1270**

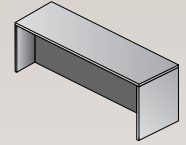

SON-11
Credenza Shell
66"x20"x29"
CU:5.2 WT:105.8
List Price: **\$1210**

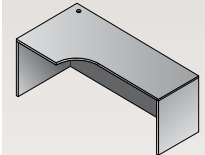

SON-82L
Left Corner Credenza
Consists of:
SON-47T, 41/47B
72"x36"x29"
CU:7.2 WT:145.5
List Price: **\$1725**

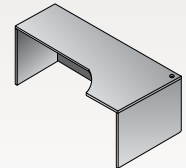

SON-82R
Right Corner Credenza
72"x36"x29"
CU:7.2 WT:145.5
List Price: **\$1725**

DESKS

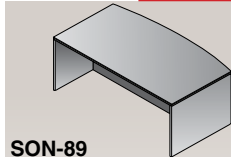

SON-89
Bow Desk Shell
72"x39"x29"
CU:7.8 WT:194.0
List Price: **\$1905**

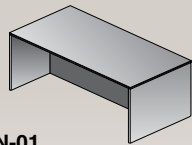

SON-01
Desk Shell
72"x36"x29"
CU:7.2 WT:179.7
List Price: **\$1815**

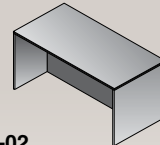

SON-02
Desk Shell
66"x30"x29"
CU:5.6 WT:138.9
List Price: **\$1530**

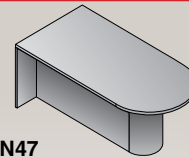

SON47
Bullet
72"x36"x29"
CU:10.3 WT:149.9
Consists of:
SON-47T, 41/47B
List Price: **\$800**
Phase Out

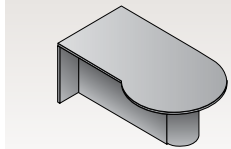

SONCHY-41L
Left P-Top
72"x36"/42"x29"
CU:11.5 WT:154.3
Consists of:
SON-41L, 41/47B
List Price: **\$950**
Phase Out

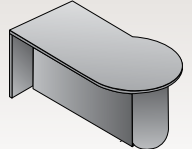

SONCHY-41R
Right P-Top
72"x36"/42"x29"
CU:11.5 WT:154.3
Consists of:
SON-41R, 41/47B
List Price: **\$950**
Phase Out

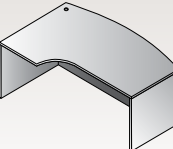

SON-87L
Left Corner Bow Desk
72"x30"/48"x29"
CU:9.4 WT:175.3
List Price: **\$2130**

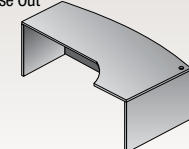

SON-87R
Right Corner Bow Desk
72"x30"/48"x29"
CU:9.4 WT:175.3
List Price: **\$2130**

RETURNS

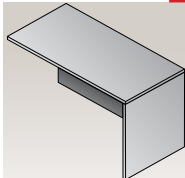

SON-45
Return Shell
48"x24"x29"
CU:3.8 WT:81.6
List Price: **\$920**

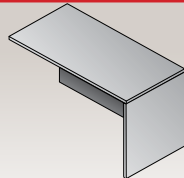

SON-96
Return
42"x24"x29"
CU:3.2 WT:85.8
List Price: **\$805**

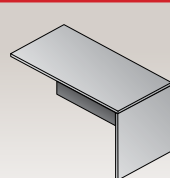

SON-92
Return Shell
36"x24"x29"
CU:2.9 WT:79.4
List Price: **\$730**

BRIDGES

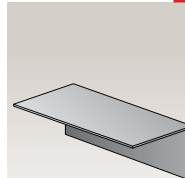

SON-70
Bridge Shell
48"x24"x29"
CU:2.9 WT:66.1
List Price: **\$740**

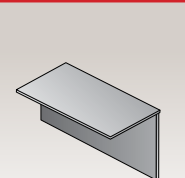

SON-93
Bridge
36"x24"x29"
CU:2.4 WT:46.3
List Price: **\$580**

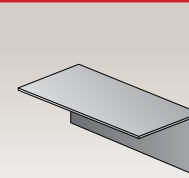

SON-98
Bridge
42"x24"x29"
CU:2.5 WT:52.8
List Price: **\$640**

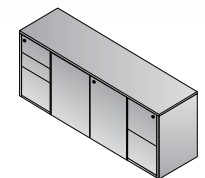

SON-10
Storage Credenza
72"x20"x29"
CU:26.6 WT:252.4
List Price: **\$3050**
Ships Assembled

PEDESTALS

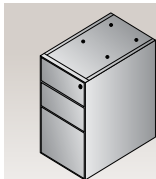

SON-65
BBF Ped-Desk
15.5"x24"x27"
CU:7.1 WT:72.8
List Price: **\$890**
Ships Assembled

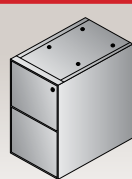

SON-74
FF Ped-Desk
15.5"x24"x27"
CU:7.1 WT:69.4
List Price: **\$890**
Ships Assembled

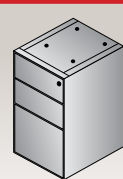

SON-66
BBF Ped-Credenza/
Return
15.5"x18"x27"
CU:5.5 WT:56.2
List Price: **\$740**
Ships Assembled

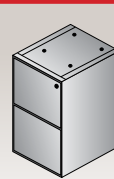

SON-75
FF Ped-Credenza/
Return
15.5"x18"x27"
CU:5.5 WT:56.2
List Price: **\$740**
Ships Assembled

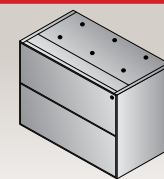

SON-68
Lateral File Ped
35"x18"x27"
CU:11.6 WT:94.8
List Price: **\$1,555**
Ships Assembled

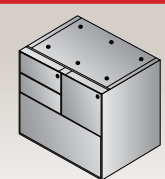

SON-69
MultiFile Ped
32"x18"x27"
CU:10.7 WT:93.7
List Price: **\$1,845**
Ships Assembled

ACCESSORIES

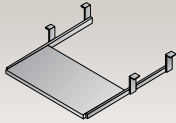

SON-14
Keyboard Tray
26"x12"
CU:0.5 WT:11.0
List Price: **\$135**

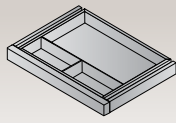

SON-15
Center Drawer
20"x15"
CU:0.7 WT:7.7
List Price: **\$110**

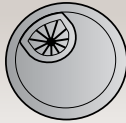

NAP-GM
Metallic Grommets (5-Pack)
2.5"x2.5"x1"
CU:0.02 WT:0.05
List Price: **\$95**

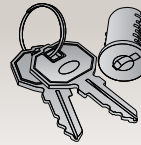

LK1-GC
Lock Core with Keys
\$15 List
KC-GC Change Key
\$8 List
KM-GC Master Key
\$8 List

HUTCH

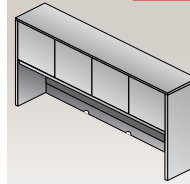

SON-44
Overhead Storage
72"x14"x42"
CU:8.0 WT:164.2
List Price: **\$1945**



NAPT-3
Tackboard for NAP42/44
SON44, KEN42/44
65"x17.5"
Black Fabric
CU:1.2 WT:10.2
List Price: **\$195**
Tackboard
Custom Fabric
NAPT- (Specify Fabric)
Grade A **\$250**
Grade B **\$280**
Grade C **\$310**
Grade R **\$340**

STORAGE & FILING

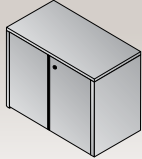

SON-13
Storage Cabinet
37"x20"x29"
CU:4.9 WT:111.3
List Price: **\$1500**

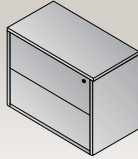

SON-12
Lateral File
37"x20"x29"
CU:14.1 WT:145.5
List Price: **\$1715**
Ships Assembled



SON-109
Four-Drawer
Lateral File
37"x20"x56"
CU:26.7 WT:221.0
List Price: **\$3600**
Ships Assembled



SON-52
Storage/File
37"x19"x70"
CU:34.0 WT:152.1
List Price: **\$4115**
Ships Assembled



SON-51
Wardrobe/Storage
37"x19"x70"
CU:10.3 WT:197.3
List Price: **\$3230**

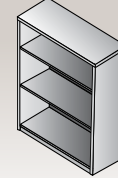

SON-55
Bookcase/Open Hutch
36"x14"x42"
CU:4.6 WT:104.7
List Price: **\$1100**

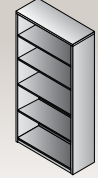

SON-56
5-Shelf Bookcase
36"x14"x70"
CU:7.8 WT:167.6
List Price: **\$1690**

RECEPTION

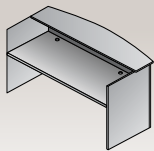

SON-122
Reception Desk
72"x30"/36"x43"
CU:9.2 WT:242.5
List Price: **\$2580**

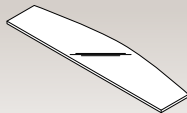

NAP-123
Glass Floating Top
Fits SON-122
71"x17.5"x0.5"
CU:2.1 WT:79.4
List Price: **\$495**

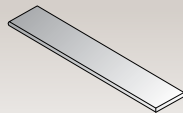

SON-124
Counter
(for return #125)
60"x12.5"
CU:1.1 WT:23.8
List Price: **\$375**

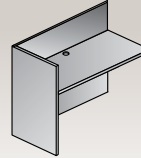

SON-125
Reception Return
42"x20"x42"
CU:3.8 WT:92.6
List Price: **\$1020**

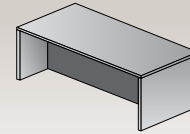

SON-19
Coffee Table
48"x24"x16"
CU:3.3 WT:63.9
List Price: **\$890**

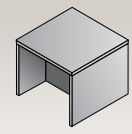

SON-20
End Table
24"x24"x20"
CU:2.1 WT:44.1
List Price: **\$615**

CONFERENCE

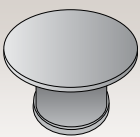

SON58
Round Table
42"Dia.x30"H
CU:13.3 WT:100.3
Consists of:
SON-58T,58B
List Price: **\$1435**

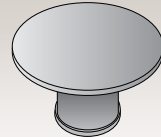

SON59
Round Table
48"Dia.x30"H
CU:17.8 WT:109.6
Consists of:
SON-59T,59/63B
List Price: **\$1690**

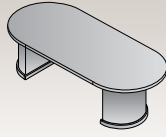

SON35
Conference Table
72"x36"x30"
CU:15.6 WT:210.1
Consists of:
SON-35T/S,35B
List Price: **\$2160**

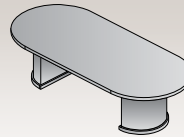

SON60
Conference Table
96"x42"x30"
CU:23.9 WT:205.5
Consists of:
SON-60T/S,60/61/62B
List Price: **\$2445**

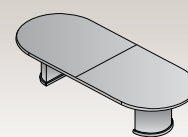

SON61
Conference Table
120"x48"x30"
CU:23.5 WT:275.6
Consists of:
SON-61T,61S,60/61/62B
List Price: **\$3445**

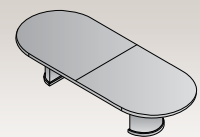

SON62
Conference Table
144"x48"x30"
CU:25.5 WT:310.9
Consists of:
SON-62T,62S,60/61/62B
List Price: **\$4185**

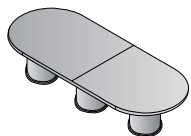

SON63
Conference Table
168"x48"x30"
CU:50.6 WT:394.8
Consists of:
SON-63T,59/63B (3 qty.)
List Price: **\$5505**

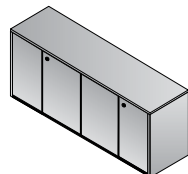

SON-50
4 Door Credenza
72"x20"x29"
CU:8.6 WT:201.7
List Price: **\$2355**

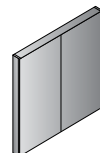

SON-100
Presentation Board
48"x48"x4"
CU:8.5 WT:110.2
List Price: **\$1720**
Ships Assembled



SON-109



SON-51



SON-52

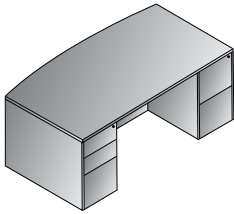

Bow Top Desk 72"x39"
SON-TYP1
22 cu. ft. 336.2 lbs.
Consists of: SON-89,65,74
\$3,685

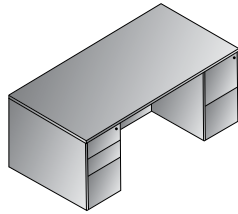

Double Pedestal Desk 72"x36"
SON-TYP2
21.4 cu. ft. 321.9 lbs.
Consists of: SON-01,65,74
\$3,595

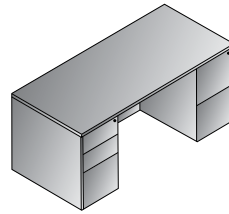

Double Pedestal Desk 66"x30"
SON-TYP3
19.8 cu. ft. 281.1 lbs.
Consists of: SON-02,65,74
\$3,310

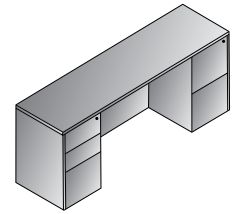

Kneespace Credenza 72"x20"
SON-TYP5
16.6 cu. ft. 233.7 lbs.
Consists of: SON-43,66,75
\$2,750

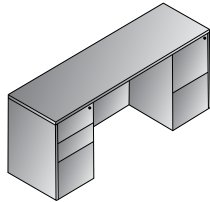

Kneespace Credenza 66x20
SON-TYP6
16.2 cu. ft. 218.2 lbs.
Consists of: SON-11,66,75
\$2,690

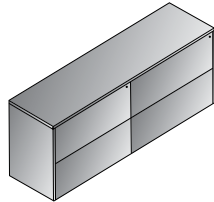

Double Lateral File Credenza 72"x20"
SON-TYP7
28.8 cu. ft. 310.9 lbs.
Consists of: SON-43,68,68
\$4,380

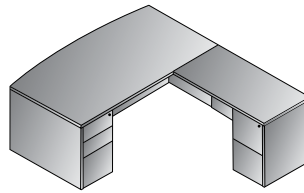

L Shape w/Bow Top Desk 72"x87"
SON-TYP8
24.2 cu. ft. 404.6 lbs.
Consists of: SON-89,65,45,75
\$4,455

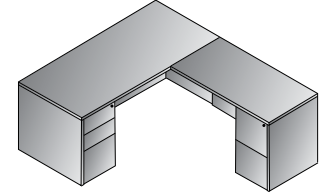

L Shape 66"x78"
SON-TYP9
22 cu. ft. 349.5 lbs.
Consists of: SON-02,65,45,75
\$4,080

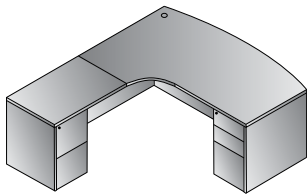

Left L Shape w/Curved Corner
72"x82"
SON-TYP10L
24.9 cu. ft. 383.7 lbs.
Consists of: SON-87L,65,92,75
\$4,490

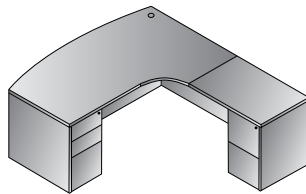

Right L Shape w/Curved Corner
72"x82"
SON-TYP10R
24.9 cu. ft. 383.7 lbs.
Consists of: SON-87R,65,92,75
\$4,490

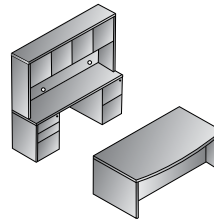

Executive Office
72"x82"
SON-TYP11
46.6 cu. ft. 734.1 lbs.
Consists of: SON-89,65,74,43, 66,75,44
\$8,380

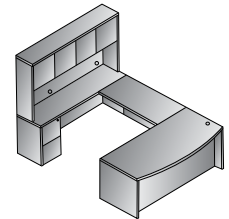

U Shape w/Hutch 72"x107"
SON-TYP12
36.9 cu. ft. 674.6 lbs.
Consists of: SON-89,65,70, 43,75,44
\$7,490

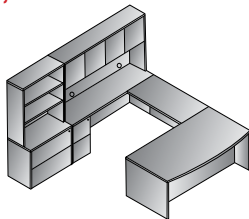

U w/Hutch + Storage 108"x107"
SON-TYP13
55.6 cu. ft. 924.8 lbs.
Consists of: SON-89,65,70, 43,75,44,12,55
\$10,305

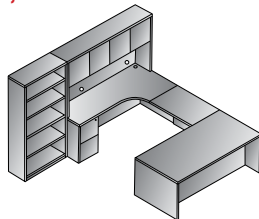

Left U Bookcase 108"x108"
SON-TYP14L
45.2 cu. ft. 832.3 lbs.
Consists of: SON-01,65,93,82R, 75,44,56
\$9,385

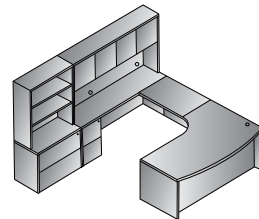

Left U w/Corner + Storage 108"x102"
SON-TYP15L
56.7 cu. ft. 886.3 lbs.
Consists of: SON-87L,65,93, 43,75,44,12,55
\$10,370

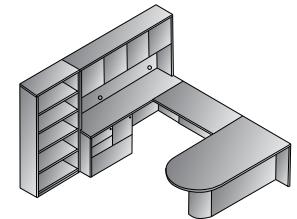

U w/Bullet + Bookcase 108"x104"
SON-TYP16
45.3 cu. ft. 761.9 lbs.
Consists of: SON-47,70,43, 69,44,56
SON47 consists of: SON-47T,41/47B
\$8,290

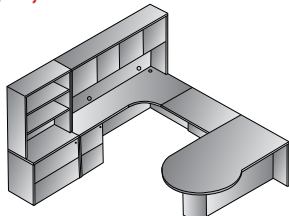

Left U w/P-Top + Storage 108"x114"
SON-TYP17L
53.3 cu. ft. 816.7 lbs.
Consists of: SON-41R,93,82R, 75,44,12,55
SON41R consists of: SON-41TR,41/47B
\$8,755

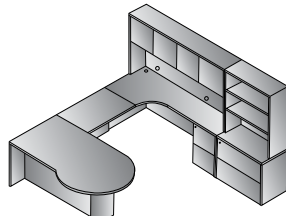

Right U w/P-Top + Storage
108"x114"
SON-TYP17R
53.3 cu. ft. 816.7 lbs.
Consists of: SON-41L,93,82L,75,44,12,55
SON41L consists of: SON-41TL,41/47B
\$8,755

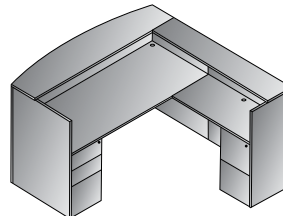

Reception Station 72"x72"x43"H
SON-TYP19
26.7 cu. ft. 487.9 lbs.
Consists of: SON-122,65,125, 75,124
\$5,605

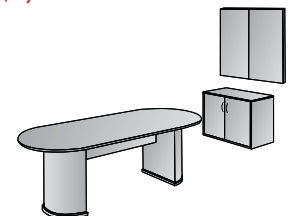

Conference Group 3-Pcs.
SON-TYP20
34.8 cu. ft. 427.3 lbs.
Consists of: SON-60,13,100
SON60 consists of: SON-60T/S,60/61/62B
\$5,665



**TOW-TYP2,
TYP5, 84, 12
and 53**

Finish Key

CHY - Royal Cherry



Unique parquet design veneer on all worksurfaces exemplifies time-honored, tradition of wood craftsmanship.

TOWNSEND blends the heritage of traditional designs with modern office function in select walnut veneers and Royal Cherry finish. Unique parquet design tops and 3"-thick shaped edge profile are further complemented with solid wood picture-frame molding, wood veneer base trim and decorative pilasters.

Modern conveniences include integral, felt-lined center drawer in all desks. Standard keyboard tray and wire management on returns, bridge and double pedestal credenza. Hutch with wire passage near worksurface and light valance. Single-key, side-locking pedestals with matching finish drawer interiors. Box and center drawers felt-lined. Desk pedestals are box/box/file. Return/credenza pedestals are file/file. All file drawers are full-extension, ball-bearing slides with Legal/Letter filing.

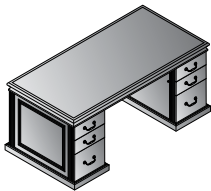

**Double Pedestal Desk 72x36x30H
TOWCHY-TYP2 \$3,820**
42.3 cu. ft. 310.9 lbs.

Consists of:
TOW-01
72x36 Desk Top/Mod Set
14.9 cu. ft. 134.5 lbs. \$1,320
TOW-65L
Left BBF Pedestal for TOW01
13.7 cu. ft. 88.2 lbs. \$1,250
TOW-65R
Right BBF Pedestal for TOW01
13.7 cu. ft. 88.2 lbs. \$1,250

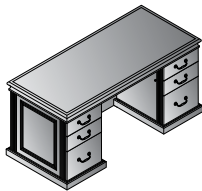

**Double Pedestal Desk 66x30x30H
TOWCHY-TYP3 \$3,630**
34.6 cu. ft. 304.2 lbs.

Consists of:
TOW-02
66x30 Desk Top/Mod Set
11.7 cu. ft. 127.9 lbs. \$1,190
TOW-63L
Left BBF Pedestal for TOW02/03
11.4 cu. ft. 88.2 lbs. \$1,220
TOW-63R
Right BBF Pedestal for TOW02/03
11.4 cu. ft. 88.2 lbs. \$1,220

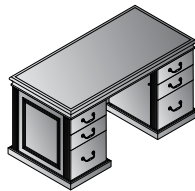

**Double Pedestal Desk 60x30x30H
TOWCHY-TYP4 \$3,490**
33.6 cu. ft. 280.0 lbs.

Consists of:
TOW-03
60x30 Desk Top/Mod Set
10.7 cu. ft. 103.6 lbs. \$1,050
TOW-63L
Left BBF Pedestal for TOW02/03
11.4 cu. ft. 88.2 lbs. \$1,220
TOW-63R
Right BBF Pedestal for TOW02/03
11.4 cu. ft. 88.2 lbs. \$1,220

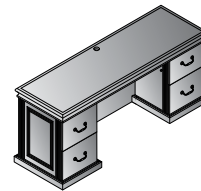

**Double Pedestal Credenza 72x24x30H
TOWCHY-TYP5 \$3,110**
31.3 cu. ft. 255.7 lbs.

Consists of:
TOW-43
72x24 Credenza Top/Mod Set
12.7 cu. ft. 105.8 lbs. \$1,260
TOW-75L
Left FF Pedestal for TOW043/45
9.3 cu. ft. 75 lbs. \$925
TOW-75R
Right FF Pedestal for TOW43/45
9.3 cu. ft. 75 lbs. \$925

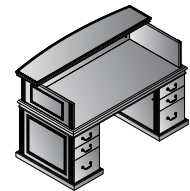

**Reception Desk 72x37x45.5H
TOWCHY-TYP119 \$4,965**
50.4 cu. ft. 410.1 lbs.

Consists of:
TOW-01
72x36 Desk Top/Mod Set
14.9 cu. ft. 134.5 lbs. \$1,320
TOW-65L
Left BBF Pedestal for TOW01
13.7 cu. ft. 88.2 lbs. \$1,250
TOW-65R
Right BBF Pedestal for TOW01
13.7 cu. ft. 88.2 lbs. \$1,250
TOW-126
72x37x15.5H Reception Station
8.1 cu. ft. 99.2 lbs. \$1,145

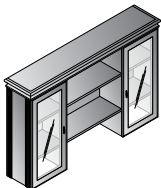

**Overhead Storage Hutch 72x15x45H
TOWCHY-84 \$2,975**
29.7 cu. ft. 231.5 lbs.

Ships in 2 cartons:
TOW-84A
(2) Towers + Back Panel
20.5 cu. ft. 149.9 lbs. \$1,885
TOW-84B
Top + (2) Shelves
5.7 cu. ft. 81.6 lbs. \$1,090

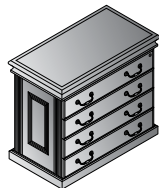

**2-Drawer Lateral File 36x20x30H
TOW-12-CHY \$1,815**
19.1 cu. ft. 149.9 lbs.

Ships Assembled in 1 carton

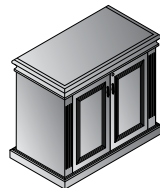

**2-Door Storage Cabinet 36x20x30H
TOW-13-CHY \$1,420**
19.8 cu. ft. 81.6 lbs.

Ships Assembled in 1 carton

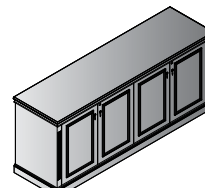

**4-Door Credenza 72x20x30H
TOW-50-CHY \$3,775**
42 cu. ft. 211.6 lbs.

Ships assembled in 1 carton

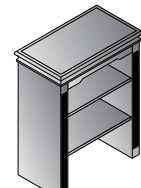

**Open Hutch 36x20x45H
TOW-53-CHY \$1,295**
10.9 cu. ft. 121.3 lbs.

Fits TOW-12 & TOW-13



TOW-61Q-CHY 120"x48" Conference Table w/Queen Anne Legs & **TWN300L-3** Townsend Leather Chair



6-Shelf Bookcase 32x14x75H
TOW-56-CHY
\$1,820
 13.1 cu. ft. 138.9 lbs.

2 Fixed (Middle, Bottom) & 4 Adjustable Shelves

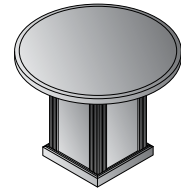

Round Table 48"Dia.x30"H
TOW-59-CHY **\$1,765**
 17.5 cu. ft. 136.7 lbs.

Ships in 2 cartons:
TOW-59T 48" Round Top
 9.2 cu. ft. 90.4 lbs.
TOW-59B Square Base
 8.3 cu. ft. 46.3 lbs.



Round Table w/Queen Anne Base
48Dx30H
TOW-59Q-CHY **\$1,660**
 10.7 cu. ft. 134.5 lbs.

Ships in 2 cartons:
TOW-59T 48" Round Top
 9.2 cu. ft. 90.4 lbs.
TOW-QAB Base
 1.5 cu. ft. 44.1 lbs.
 Queen Anne Base (assembly required)

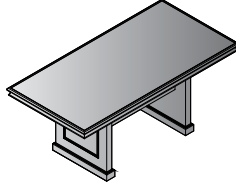

Rectangular Table
72x36x30H
TOW-35-CHY **\$3,585**
 17.7 cu. ft. 260.1 lbs.

Ships in 2 cartons:
TOW-35T/S Top & Stretchers
 13.3 cu. ft. 189.6 lbs.
TOW-35B Base (Set of 2 Legs)
 4.3 cu. ft. 70.5 lbs.

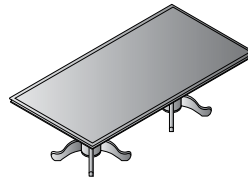

Rectangular Table w/Queen Anne Base
72x36x30H
TOW-35Q-CHY **\$3,830**
 16.3 cu. ft. 277.8 lbs.

Ships in 3 cartons:
TOW-35T/S Top & Stretchers
 13.3 cu. ft. 189.6 lbs.
TOW-QAB Base (2 qty)
 1.5 cu. ft. 44.1 lbs.
 Queen Anne Base (assembly required)

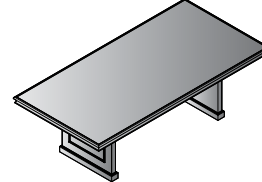

Rectangular Table
96x48x30H
TOW-60-CHY **\$3,800**
 29.2 cu. ft. 304.2 lbs.

Ships in 2 cartons:
TOW-60T/S Top & Stretchers
 23.0 cu. ft. 189.6 lbs.
TOW-60/61B Base (Set of 2 Legs)
 6.2 cu. ft. 114.6 lbs.

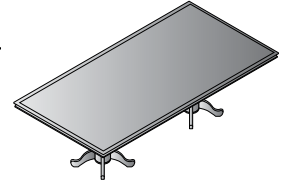

Rectangular Table
96x48x30H
TOW-60Q-CHY **\$4,055**
 26 cu. ft. 277.8 lbs.

Ships in 3 cartons:
TOW-60T/S Top & Stretchers
 23.0 cu. ft. 189.6 lbs.
TOW-QAB Base (2 qty)
 1.5 cu. ft. 44.1 lbs.
 Queen Anne Base (assembly required)

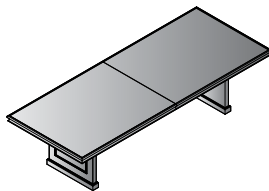

Rectangular Table
120x48x30H
TOW-61-CHY **\$4,750**
 28.2 cu. ft. 418.9 lbs.

Ships in 3 cartons:
TOW-61T Top (2-piece)
 19.0 cu. ft. 224.9 lbs.
TOW-61S Stretchers (2)
 3.0 cu. ft. 79.4 lbs.
TOW-60/61B Base (set of 2 Legs)
 6.2 cu. ft. 114.6 lbs.

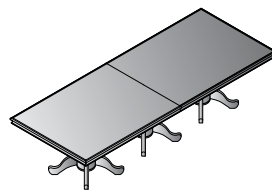

Rectangular Table w/Queen Anne Base
120x48x30H
TOW-61Q-CHY **\$4,940**
 23.5 cu. ft. 357.1 lbs.

Ships in 4 cartons:
TOW-61T Top (2-piece)
 19.0 cu. ft. 224.9 lbs.
TOW-QAB Base (3 qty)
 1.5 cu. ft. 44.1 lbs.
 Queen Anne Base (assembly required)

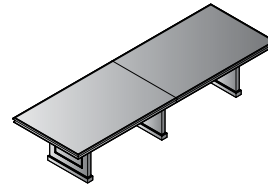

Rectangular Table 144x48x30H
TOW-62-CHY **\$6,250**
 32.8 cu. ft. 421.1 lbs.

Ships in 2 cartons:
TOW-62T/S Top (2-piece) & Stretchers
 (4) 24.8 cu. ft. 277.8 lbs.
TOW-62B Base (Set of 3 Legs)
 8.0 cu. ft. 143.3 lbs.

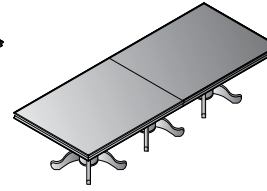

Rectangular Table w/Queen Anne Base
144x48x30H
TOW-62Q-CHY **\$6,625**
 29.3 cu. ft. 410.1 lbs.

Ships in 4 cartons:
TOW-62T/S Top (2-piece) & Stretchers
 (4) 24.8 cu. ft. 277.8 lbs.
TOW-QAB Base (3 qty)
 1.5 cu. ft. 44.1 lbs.
 Queen Anne Base (assembly required)

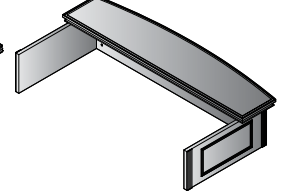

Reception Station 72x37x15.5H
TOW-126-CHY **\$1,145**
 8.1 cu. ft. 99.2 lbs.

Fits 72"x36" Desks

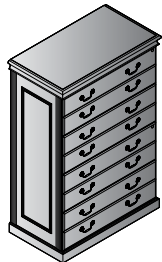

4-Drawer Lateral File 36x20x54H
TOW-109-CHY **\$3,330**
 32.3 cu. ft. 216 lbs.

Ships assembled in 1 carton



★ **TWN300L-3 Executive Leather Chair w/Royal Cherry Wood Finish Arms & Base**

Overall Size: 26W x 30D x 37.25H

Seat: 20W x 20D x 4.5T Seat Range: 18.5 -21

Back: 20W x 26.5H x 4.5T

Arms to Floor: 27.5 Carton Wt: 61 UPS Wt: 155

Carton: 27L x 42W x 28H Cube: 18.3

Options: CG50, SW70

Features: 1, 4, 6, 8, 9 Control: Knee Tilt

Notes: UPSable, Oversized Package Available in New Jersey only.

Fabric	List Price
Top Grain Leather with Royal Cherry Finish	\$990.00

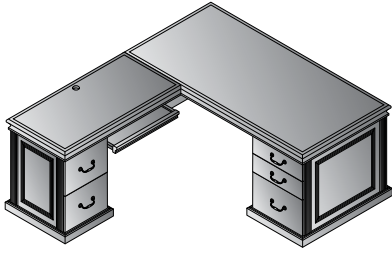

L-Shape with Left Return 72"x84"
TOWCHY-TYP8L **\$5,135**
 42.6 cu. ft. 346.1 lbs.

- Consists of:
- TOW-01R** 72x36x30H Right DeskTop/Mod Set
17.8 cu. ft. 134.5 lbs. \$1,710
 - TOW-64R** Right BBF Pedestal for TOW01R
16.1 cu. ft. 134.5 lbs. \$1,575
 - TOW-45L** Left Return Top/Mod Set 48x24x30H
8.7 cu. ft. 77.2 lbs. \$925
 - TOW-75L** Left FF Pedestal for TOW043/45
9.3 cu. ft. 75 lbs. \$925

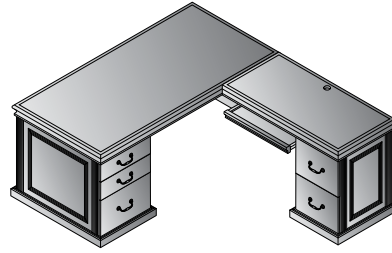

L-Shape with Right Return 72"x84"
TOWCHY-TYP8R **\$5,135**
 42.6 cu. ft. 346.1 lbs.

- Consists of:
- TOW-01L** 72x36x30H Left Desk Top/Mod Set
17.8 cu. ft. 134.5 lbs. \$1,710
 - TOW-64L** Left BBF Pedestal for TOW01L
16.1 cu. ft. 134.5 lbs. \$1,575
 - TOW-45R** Right Return Top/Mod Set 48x24x30H
8.7 cu. ft. 77.2 lbs. \$925
 - TOW-75R** Right FF Pedestal for TOW043/45
9.3 cu. ft. 75 lbs. \$925

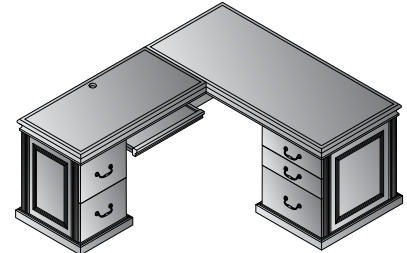

L-Shape with Left Return 66"x78"
TOWCHY-TYP9L **\$4,530**
 36.1 cu. ft. 310.9 lbs.

- Consists of:
- TOW-02R** 66x30x30H Right Desk Top/Mod Set
13.9 cu. ft. 136.7 lbs. \$1,360
 - TOW-62R** Right BBF Pedestal for TOW02R
13.4 cu. ft. 97.0 lbs. \$1,320
 - TOW-45L** Left Return Top/Mod Set 48x24x30H
8.7 cu. ft. 77.2 lbs. \$925
 - TOW-75L** Left Pedestal for TOW043/45
9.3 cu. ft. 75 lbs. \$925

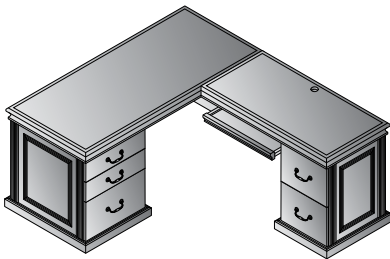

L-Shape with Right Return 66"x78"
TOWCHY-TYP9R **\$4,530**
 36.1 cu. ft. 310.9 lbs.

- Consists of:
- TOW-02L** 66x30x30H Left Desk Top/Mod Set
13.9 cu. ft. 136.7 lbs. \$1,360
 - TOW-62L** Left BBF Pedestal for TOW02L
13.4 cu. ft. 97.0 lbs. \$1,320
 - TOW-45R** Right Return Top/Mod Set 48x24x30H
8.7 cu. ft. 77.2 lbs. \$925
 - TOW-75R** Right Pedestal for TOW043/45
9.3 cu. ft. 75 lbs. \$925

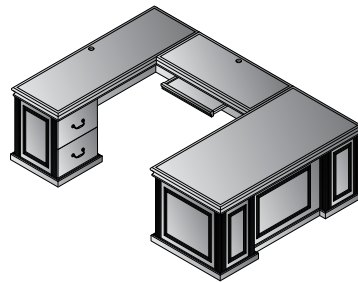

U-Shape with Left Bridge 72"x108"
TOWCHY-TYP22L **\$6,975**
 68.9 cu. ft. 546.7 lbs.

- Consists of:
- TOW-01R** 72x36x30H Right DeskTop/Mod Set
17.8 cu. ft. 134.5 lbs. \$1,710
 - TOW-64R** Right BBF Pedestal for TOW01R
16.1 cu. ft. 134.5 lbs. \$1,575
 - TOW-70** Bridge 48x24x30H
10.3 cu. ft. 88.2 lbs. \$1,115
 - TOW-43L** 72x24x30H Left Credenza Top/Mod Set
13.8 cu. ft. 114.6 lbs. \$1,250
 - TOW-78L** Left FF Pedestal for TOW043L
10.9 cu. ft. 75 lbs. \$1,325

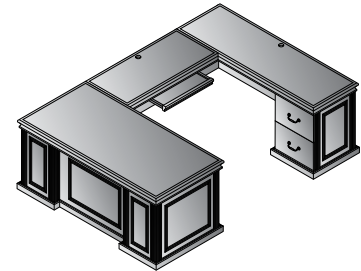

U-Shape with Right Bridge 72"x108"
TOWCHY-TYP22R **\$6,975**
 68.9 cu. ft. 546.7 lbs.

- Consists of:
- TOW01L** 72x36x30H Left DeskTop/Mod Set
17.8 cu. ft. 134.5 lbs. \$1,710
 - TOW-64L** Left BBF Pedestal for TOW01L
16.1 cu. ft. 134.5 lbs. \$1,575
 - TOW-70** Bridge 48x24x30H
10.3 cu. ft. 88.2 lbs. \$1,115
 - TOW-43R** 72x24x30H Right Credenza Top/Mod Set
13.8 cu. ft. 114.6 lbs. \$1,250
 - TOW-78R** Right FF Pedestal for TOW043R
10.9 cu. ft. 75 lbs. \$1,325

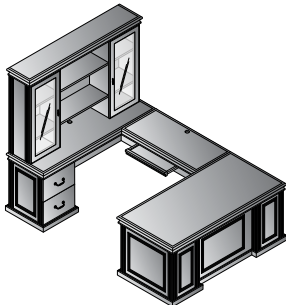

U-Shape with Left Bridge + Hutch 72"x108"
TOWCHY-TYP12L **\$9,950**
 98.6 cu. ft. 778.2 lbs.

- Consists of: (7 cartons)
- TOW-01R** 72x36x30H Right DeskTop/Mod Set
17.8 cu. ft. 134.5 lbs. \$1,710
 - TOW-64R** RightBBF Pedestal for TOW01R
16.1 cu. ft. 134.5 lbs. \$1,575
 - TOW-70** Bridge 48x24x30H
10.3 cu. ft. 88.2 lbs. \$1,115
 - TOW-43L** 72x24x30H Left Credenza Top/Mod Set
13.8 cu. ft. 114.6 lbs. \$1,250
 - TOW-78L** Left FF Pedestal for TOW043L
10.9 cu. ft. 75 lbs. \$1,325
 - TOW-84** Overhead Storage Hutch 72x15x45H
26.2 cu. ft. 231.5 lbs. \$2,975
Consists of TOW-84A, TOW-84B

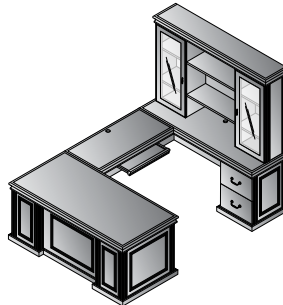

U-Shape with Right Bridge + Hutch 72"x108"
TOWCHY-TYP12R **\$9,950**
 98.6 cu. ft. 778.2 lbs.

- Consists of: (7 cartons)
- TOW-01L** 72x36x30H Left DeskTop/Mod Set
17.8 cu. ft. 134.5 lbs. \$1,710
 - TOW-64L** Left BBF Pedestal for TOW01L
16.1 cu. ft. 134.5 lbs. \$1,575
 - TOW-70** Bridge 48x24x30H
10.3 cu. ft. 88.2 lbs. \$1,115
 - TOW-43R** 72x24x30H Right Credenza Top/Mod Set
13.8 cu. ft. 114.6 lbs. \$1,250
 - TOW-78R** Right FF Pedestal for TOW043R
10.9 cu. ft. 75 lbs. \$1,325
 - TOW-84** Overhead Storage Hutch 72x15x45H
26.2 cu. ft. 231.5 lbs. \$2,975
Consists of TOW-84A, TOW-84B

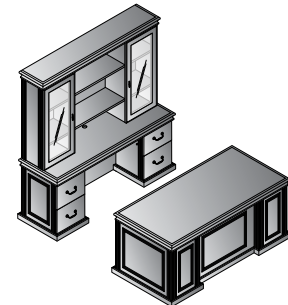

Executive Office
TOWCHY-TYP11 **\$9,905**
 103.3 cu. ft. 798.1 lbs.

- Consists of: (8 cartons)
- TOW-TYP2** 72x36x30H Double Pedestal Desk
42.3 cu. ft. 310.9 lbs. \$3,820
 - TOW-TYP5** 72x24x30H Double Pedestal Credenza
31.3 cu. ft. 255.7 lbs. \$3,110
 - TOW-84** Overhead Storage Hutch 72x15x45H
26.2 cu. ft. 231.5 lbs. \$2,975
Consists of TOW-84A, TOW-84B

Design for the connoisseur, Mendocino brings together executive style, characteristics and function. Complex shape work surface edges coordinate with decorative pedestal and hutch tops. Enhanced features include legal-width desk pedestals, austere 80" heights (credenza/hutch), and a dramatic showcase hutch with beveled wood frame/clear glass doors. Select hardwood veneers in Cherry or Mahogany satin finish.



Finish Key

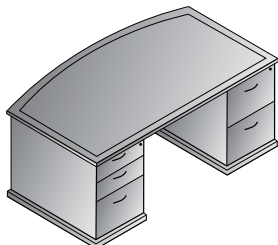

Bow Top Desk 84x44x30H
MENxxx-TYP901 \$5,005
 38.7 cu.ft. 364.0 lbs.

Consists of (3 cartons):
MEN-90 84x42 Bow Desk Set
 9.3 cu.ft. 139 lbs. \$2,295
MEN-65 BBF Ped 72"/84" Desks
 14.7 cu.ft. 111 lbs. \$1,305
MEN-74 FF Ped 72"/84" Desks
 14.7 cu.ft. 114.0 lbs. \$1,405
Ships in 2 cartons

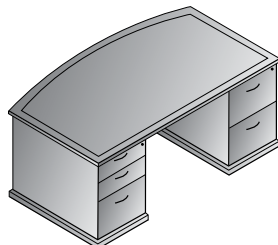

Bow Top Desk 72x42x30H
MENxxx-TYP1 \$4,200
 37.8 cu.ft. 372.6 lbs.

Consists of (3 cartons):
MEN-89 72x42 Bow Desk Set
 7.3 cu.ft. 119.0 lbs. \$1,490
MEN-65 BBF Ped 72"/84" Desks
 14.7 cu.ft. 111.0 lbs. \$1,305
MEN-74 FF Ped 72"/84" Desks
 14.7 cu.ft. 114.0 lbs. \$1,405

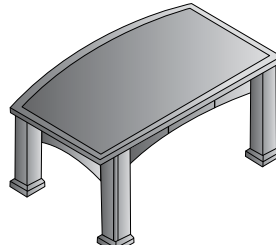

Bow Top Table Desk 72x42x30H
MEN-04-xxx \$3,440
 17.6 cu.ft. 183 lbs.

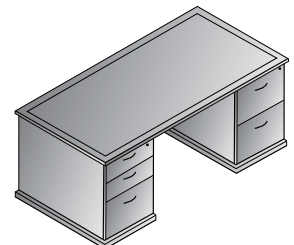

Double Pedestal Desk 72x36x30H
MENxxx-TYP2 \$4,200
 36.8 cu.ft. 350.5 lbs.

Consists of (3 cartons):
MEN-01 72x36 Bow Desk Set
 6.4 cu.ft. 115 lbs. \$1,490
MEN-65 BBF Ped 72"/84" Desks
 14.7 cu.ft. 111.0 lbs. \$1,305
MEN-74 FF Ped 72"/84" Desks
 14.7 cu.ft. 114.0 lbs. \$1,405

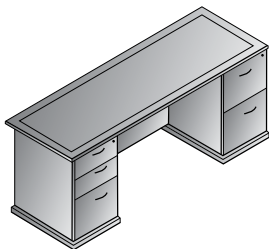

Kneespace Credenza 72x24x30H
MENxxx-TYP5 \$3,190
 23.0 cu.ft. 252.5 lbs.

Consists of (3 cartons):
MEN-43 72x24 Credenza Set
 4.6 cu.ft. 74.0 lbs. \$1,180
MEN-66 BBF Ped Credenza/Return
 8.7 cu.ft. 77.0 lbs. \$985
MEN-75 FF Ped Credenza/Return
 8.7 cu.ft. 78.0 lbs. \$1,025

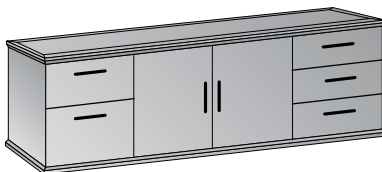

Storage Credenza 72x24x30H
MEN-10-xxx \$3,630
 36.0 cu.ft. 271 lbs.
Ships Assembled

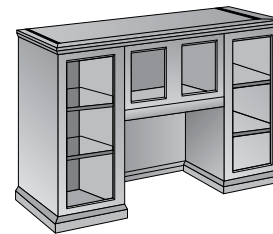

Hutch with Glass Doors 72x16x49H
MENxxx-84 \$3,190
 26.3 cu.ft. 213.0 lbs.

Consists of (2 cartons):
MEN-84A Towers
MEN-84B Top/Shelves/Back Panels
Ships in 2 cartons

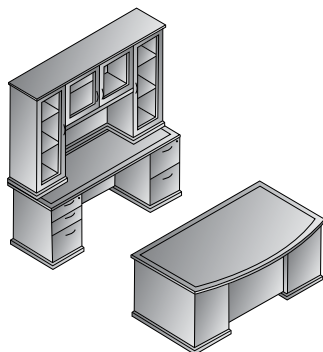

Executive Office
MENxxx-TYP11 \$10,580
 99.7 cu.ft. 863.2 lbs.

Consists of (8 cartons):
MEN-89 72x42 Bow Desk Set
 7.3 cu.ft. 119.0 lbs. \$1,490
MEN-65 BBF Ped 72"/84" Desks
 14.7 cu.ft. 111.0 lbs. \$1,305
MEN-74 FF Ped 72"/84" Desks
 14.7 cu.ft. 114.0 lbs. \$1,405
MEN-43 72x24 Credenza Set
 4.6 cu.ft. 74.0 lbs. \$1,180
MEN-66 BBF Ped Credenza/Return
 8.7 cu.ft. 77.0 lbs. \$985
MEN-75 FF Ped Credenza/Return
 8.7 cu.ft. 78.0 lbs. \$1,025
MENxxx-84 Hutch with Glass Doors
 26.3 cu.ft. 213.0 lbs. \$3,190
Consists of MEN-84A, MEN-84B

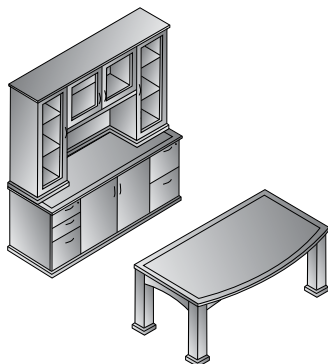

Executive Office with Table Desk
MENxxx-TYP211 \$10,260
 92.6 cu.ft. 724.0 lbs.

Consists of (4 cartons):
MEN-04 72x42 Table Desk
 17.6 cu.ft. 183 lbs. \$3,440
MEN-10 Storage Credenza
 36.0 cu.ft. 271 lbs. \$3,630
MENxxx-84 Hutch with Glass Doors
 26.3 cu.ft. 213.0 lbs. \$3,190
Consists of MEN-84A, MEN-84B

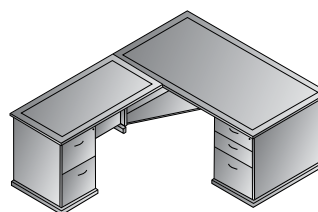

L-Shape 66x78x30H
MENxxx-TYP219 \$4,780
 41.0 cu.ft. 382.1 lbs.

Consists of (5 cartons):
MEN-02 66x30 Desk Set
 5.0 cu.ft. 93 lbs. \$1,180
MEN-63 BBF Ped 66" Desks
 10.7 cu.ft. 91.0 lbs. \$1,240
MEN-67 False Ped 66" Desks
 9.1 cu.ft. 46.0 lbs. \$605
MEN-45 48x24 Return Set
 3.3 cu.ft. 65.0 lbs. \$730
MEN-75 FF Ped Credenza/Return
 8.7 cu.ft. 78.0 lbs. \$1,025
Not Available in Mahogany

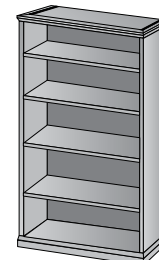

5-Shelf Bookcase 36x16x79H
MEN-56-xxx \$1,650
 8.5 cu.ft. 177 lbs.

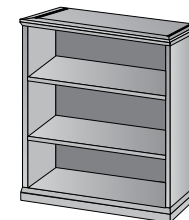

3-Shelf Bookcase 36x16x49H
MEN-55-xxx \$1,210
 5.7 cu.ft. 121 lbs.

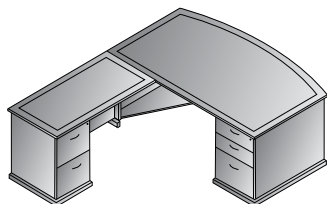

L-Shape w/Bow Top Desk 72x90x30H
MENxxx-TYP8 \$5,280
 51.5 cu.ft. 461.9 lbs.

Consists of (5 cartons):
MEN89 72x42 Bow Desk Set
 7.3 c-u.ft. 119.0 lbs. \$1,490
MEN-65 BBF Ped 72"/84" Desks
 14.7 cu.ft. 111.0 lbs. \$1,305
MEN-71 False Ped 72"/84" Desks
 12.4 cu.ft. 56.0 lbs. \$730
MEN-45 48x24 Return Set
 3.0 cu.ft. 62.0 lbs. \$730
MEN-75 FF Ped Credenza/Return
 8.7 cu.ft. 78.0 lbs. \$1,025

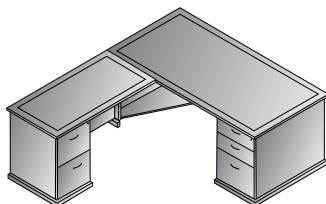

L-Shape 72x84x30H
MENxxx-TYP9 \$5,280
 50.5 cu.ft. 439.8 lbs.

Consists of (5 cartons):
MEN-01 72x36 Desk Set
 6.4 cu.ft. 115 lbs. \$1,490
MEN-65 BBF Ped 72"/84" Desks
 14.7 cu.ft. 111.0 lbs. \$1,305
MEN-71 False Ped 72"/84" Desks
 12.4 cu.ft. 56.0 lbs. \$730
MEN-45 48x24 Return Set
 3.0 cu.ft. 62.0 lbs. \$730
MEN-75 FF Ped Credenza/Return
 8.7 cu.ft. 78.0 lbs. \$1,025

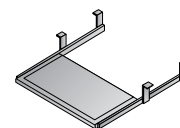

Keyboard Tray 26x12
MEN-14-xxx \$410
 0.5 cu.ft. 12 lbs.

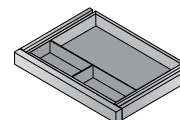

Center Drawer 20x16
MEN-15-xxx \$255
 0.7 cu.ft. 10 lbs.

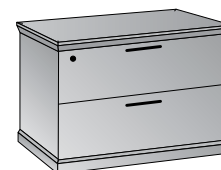

2-Drawer Lateral File 36x24x30H
MEN-12-xxx \$1,755
 18.6 cu.ft. 146 lbs.
Ships Assembled

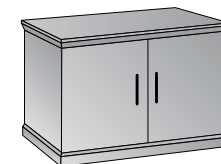

2-Door Storage Cabinet 36x24x30H
MEN-13-xxx \$1,595
 5.5 cu.ft. 118 lbs.
Now requires assembly.

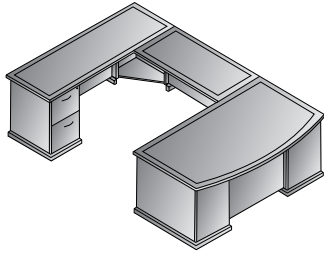

U-Shape 72x114
MENxxx-TYP22 \$7,195
 66.3 cu.ft. 598.6 lbs.

- Consists of (7 cartons):
MEN-89 72x42 Bow Desk Set
 7.3 cu.ft. 119.0 lbs. \$1,490
MEN-65 BBF Ped 72"/84" Desks
 14.7 cu.ft. 111.0 lbs. \$1,305
MEN-71 False Ped 72"/84" Desks
 12.4 cu.ft. 56.0 lbs. \$730
MEN-70 48x24 Bridge
 3.1 cu.ft. 63.0 lbs. \$955
MEN-43 72x24 Credenza Set
 4.6 cu.ft. 74.0 lbs. \$1,180
MEN-73 False Ped Credenza/Return
 7.8 cu.ft. 43.0 lbs. \$510
MEN-75 FF Ped Credenza/Return
 8.7 cu.ft. 78.0 lbs. \$1,025

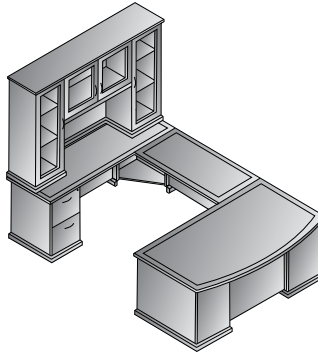

U-Shape + Glass Door Hutch 72x114
MENxxx-TYP213 \$10,385
 105.2 cu.ft. 836.7 lbs.

- Consists of (9 cartons):
MEN-89 72x42 Bow Desk Set
 7.3 cu.ft. 119.0 lbs. \$1,490
MEN-65 BBF Ped 72"/84" Desks
 14.7 cu.ft. 111.0 lbs. \$1,305
MEN-71 False Ped 72"/84" Desks
 12.4 cu.ft. 56.0 lbs. \$730
MEN-70 48x24 Bridge
 3.1 cu.ft. 63.0 lbs. \$955
MEN-43 72x24 Credenza Set
 4.6 cu.ft. 74.0 lbs. \$1,180
MEN-73 False Ped Credenza/Return
 7.8 cu.ft. 43.0 lbs. \$510
MEN-75 FF Ped Credenza/Return
 8.7 cu.ft. 78.0 lbs. \$1,025
MENxxx-84 Hutch with Glass Doors
 26.3 cu.ft. 213.0 lbs. \$3,190
 Consists of MEN-84A, MEN-84B

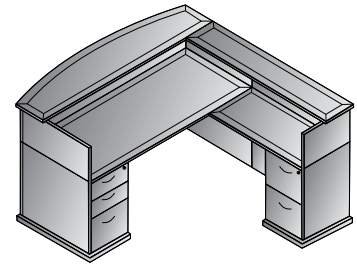

Reception Station 72x90x43H
MENxxx-TYP19 \$7,315
 56.3 cu.ft. 563.7 lbs.

- Consists of (7 cartons):
MEN-01 72x36 Desk Set
 6.4 cu.ft. 115 lbs. \$1,490
MEN-65 BBF Ped 72"/84" Desks
 14.7 cu.ft. 111.0 lbs. \$1,305
MEN-71 False Ped 72"/84" Desks
 12.4 cu.ft. 56.0 lbs. \$730
MEN-45 48x24 Return Set
 3.0 cu.ft. 62.0 lbs. \$730
MEN-75 FF Ped Credenza/Return
 8.7 cu.ft. 78.0 lbs. \$1,025
MEN-127 Reception Unit MAIN 72x35x13H
 3.6 cu.ft. 71 lbs. \$1,240
MEN-128 Reception Unit RETURN 72x24x13H
 2.2 cu.ft. 46.0 lbs. \$795

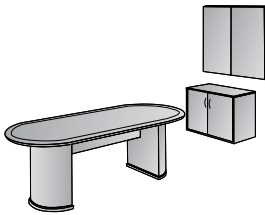

Conference Group 3 pcs.
MENxxx-TYP20 \$6,965
 50.3 cu.ft. 465.3 lbs.

- Consists of (4 cartons):
MEN-60 Conference Table 96x42x30H
 21.4 cu.ft. 190 lbs. \$3,200
MEN-13 2-Door Storage Cabinet
 5.5 cu.ft. 118 lbs. \$1,595
MEN-100 Presentation Board
 10.4 cu.ft. 112.0 lbs. \$2,170

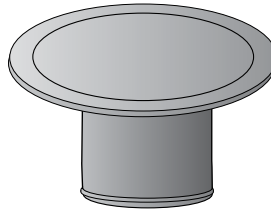

Conference Table 48" Dia. X 30H
MENxxx-59 \$1,930
 13.0 cu.ft. 99 lbs.

- Ships in 2 cartons:
MEN-59T Top
MEN-59B Base
Not Available in Mahogany

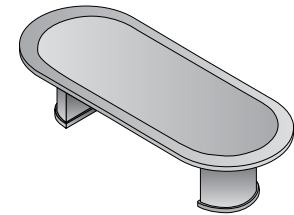

Conference Table 96x42x30H
MENxxx-60 \$3,200
 21.4 cu.ft. 190 lbs.

- Ships in 2 cartons:
MEN-60T/S Top & Stretcher
MEN-60/61/62B Base (2 pcs)

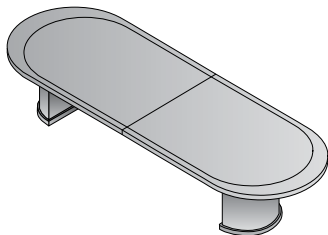

Conference Table 144x48x30H
MENxxx-62 \$4,845
 21.7 cu.ft. 229 lbs.

- Ships in 3 cartons:
MEN-62T Top (2 pcs)
MEN-62S Stretcher
MEN-60/61/62B Base (2 pcs)

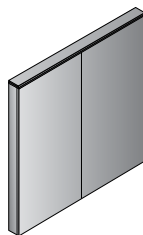

Presentation Board 48Wx6Dx48H
MEN-100-xxx \$2,170
 12.4 cu.ft. 112.0 lbs.
Ships Assembled
Not Available in Cherry

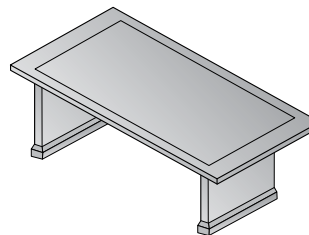

Coffee Table 48x24x16H
MEN-19-xxx \$925
 4.0 cu.ft. 56 lbs.

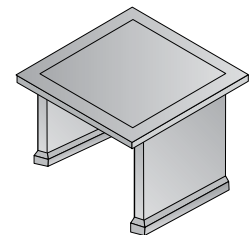

End Table 24x24x20H
MEN-20-xxx \$730
 2.3 cu.ft. 44 lbs.



Modular table components allow you to build tables as long as you want!



Rectangular Tops (Sold 1/Carton)

- SON-103** 3' Top 36W x 27D
Wt: 48.4 Cu: 2.1 **List: \$630**
- SON-104** 4' Top 48W x 27D
Wt: 66.0 Cu: 2.7 **List: \$925**
- SON-105** 5' Top 60W x 27D
Wt: 81.4 Cu: 3.4 **List: \$1140**
- SON-106** 6' Top 72W x 27D
Wt: 96.8 Cu: 4.0 **List: \$1400**



SON-116-2 Half-Round Table Ends
(Set of 2) 63W x 31D
Wt: 158.4 Cu: 7.1 **List: \$1910**

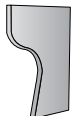

SON-102-2 Legs (Set of 2)
Wt: 55.0 Cu: 2.1 **List: \$630**



COVER PANELS Black Faux Leather
CP1 Cover Panels for Half-Round Ends
(Set of 2)
Wt: 0.5 Cu: 0.05 **List: \$38**

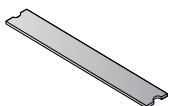

- CP3** 3' Wide Cover Panel Wt: 1.25 Cu: 0.2 **List: \$80**
- CP4** 4' Wide Cover Panel Wt: 1.5 Cu: 0.28 **List: \$125**
- CP5** 5' Wide Cover Panel Wt: 1.75 Cu: 0.35 **List: \$155**
- CP6** 6' Wide Cover Panel Wt: 2.0 Cu: 0.43 **List: \$190**



Includes built-in center cord-drop area shown without cover panels.
Optional cover panels shown in photo at top of page.

- Choose from 4 widths of rectangular tops and configure to infinite number of sizes
- Requires half-round table ends (63"x31") at each end
- Requires one Leg for each top connection and for each table end
- Standard 63" wide with built-in center cord-drop
- Optional Cover Panels enclose the center area; feature black faux leather
- See Configuration Guide on page 68

Finish Key

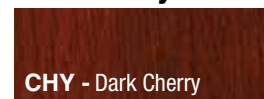

Configuration Guide

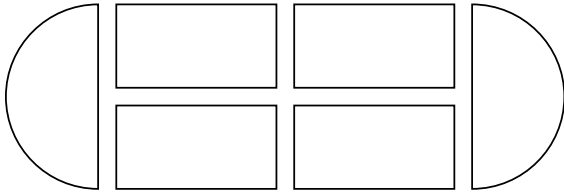

15' Table

List Price: \$8,990

704 lb. 29.1 cu ft

Consists of:

(4) SON-105

5' Top 60W x 27D

(4) SON-102-2

Legs (Set of 2)

(1) SON-116-2

Half-Round Table Ends

(Set of 2) 63W x 31D

17' Table

List Price: \$10,030

765.6 lb. 31.5 cu ft

Consists of:

(4) SON-106

6' Top 72W x 27D

(4) SON-102-2

Legs (Set of 2)

(1) SON-116-2

Half-Round Table Ends

(Set of 2) 63W x 31D

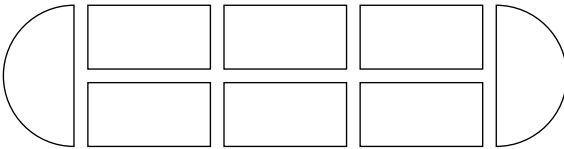

16' Table

List Price: \$10,020

794.2 lb. 32.6 cu ft

Consists of:

(4) SON-104

4' Top 48W x 27D

(2) SON-103

3' Top 36W x 27D

(5) SON-102-2

Legs (Set of 2)

(1) SON-116-2

Half-Round Table Ends

(Set of 2) 63W x 31D

18' Table

List Price: \$11,040

860.2 lb. 35.2 cu ft

Consists of:

(4) SON-104

4' Top 48W x 27D

(2) SON-105

5' Top 60W x 27D

(5) SON-102-2

Legs (Set of 2)

(1) SON-116-2

Half-Round Table Ends

(Set of 2) 63W x 31D

19' Table

List Price: \$11,470

891 lb. 36.6 cu ft

Consists of:

(4) SON-105

5' Top 60W x 27D

(2) SON-104

4' Top 48W x 27D

(5) SON-102-2

Legs (Set of 2)

(1) SON-116-2

Half-Round Table Ends

(Set of 2) 63W x 31D

20' Table

List Price: \$11,900

921.8 lb. 38 cu ft

Consists of:

(6) SON-105

5' Top 60W x 27D

(5) SON-102-2

Legs (Set of 2)

(1) SON-116-2

Half-Round Table Ends

(Set of 2) 63W x 31D

21' Table

List Price: \$12,510

952.6 lb. 39 cu ft

Consists of:

(4) SON-106

6' Top 72W x 27D

(2) SON-104

4' Top 48W x 27D

(5) SON-102-2

Legs (Set of 2)

(1) SON-116-2

Half-Round Table Ends

(Set of 2) 63W x 31D

22' Table

List Price: \$12,940

983.4 lb. 40.4 cu ft

Consists of:

(4) SON-106

6' Top 72W x 27D

(2) SON-105

5' Top 60W x 27D

(5) SON-102-2

Legs (Set of 2)

(1) SON-116-2

Half-Round Table Ends

(Set of 2) 63W x 31D

23' Table

List Price: \$13,460

1014.2 lb. 41.6 cu ft

Consists of:

(6) SON-106

6' Top 72W x 27D

(5) SON-102-2

Legs (Set of 2)

(1) SON-116-2

Half-Round Table Ends

(Set of 2) 63W x 31D

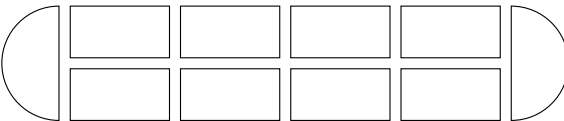

25' Table

List Price: \$14,810

1139.6 lb. 46.9 cu ft

Consists of:

(8) SON-105

5' Top 60W x 27D

(6) SON-102-2

Legs (Set of 2)

(1) SON-116-2

Half-Round Table Ends

(Set of 2) 63W x 31D

27' Table

List Price: \$15,850

1201.2 lb. 49.3 cu ft

Consists of:

(4) SON-106

6' Top 72W x 27D

(4) SON-105

5' Top 60W x 27D

(6) SON-102-2

Legs (Set of 2)

(1) SON-116-2

Half-Round Table Ends

(Set of 2) 63W x 31D

29' Table

List Price: \$16,890

1262.8 lb. 51.7 cu ft

Consists of:

(8) SON-106

6' Top 72W x 27D

(6) SON-102-2

Legs (Set of 2)

(1) SON-116-2

Half-Round Table Ends

(Set of 2) 63W x 31D



Dress up any office with Tuxedo. Contract-grade laminates are accented with Silver reveal and base trim, aluminum finish drawer pulls and frosted glass/aluminum frame modesty panels and hutch doors. Silver-finish dual-electric, dual-USB power unit is standard in all bridges, returns and table tops to instantly power office technology. Full depth pedestals and full-height modesty panels are standard. Pedestals include single-key, side locking. Modular table components create 48" round, 48" square and expandable rectangular conference tables. Tables feature standard dual-electric, dual-USB power unit with 3-way wire management in all table bases.

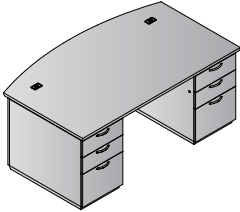

Bow Front Double Ped Desk 72x42
TUXxxx-TYP1
 43.5 cu.ft. 392.4 lbs. **\$3,160**

Consists of (3 cartons):
TUX-89 72x42 Bow Front Desk Set
 10.6 cu.ft. 127.9 lbs. \$860
TUX-65L Left BBF Pedestal
 16.4 cu.ft. 132.3 lbs. \$1,150
TUX-65R Right BBF Pedestal
 16.4 cu.ft. 132.3 lbs. \$1,150

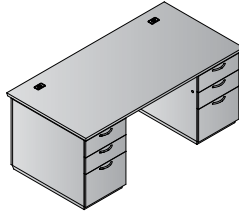

Double Pedestal Desk 72x36
TUXxxx-TYP2
 43.5 cu.ft. 383.6 lbs. **\$3,100**

Consists of (3 cartons):
TUX-01 72x36 Desk Set
 10.6 cu.ft. 119 lbs. \$800
TUX-65L Left BBF Pedestal
 16.4 cu.ft. 132.3 lbs. \$1,150
TUX-65R Right BBF Pedestal
 16.4 cu.ft. 132.3 lbs. \$1,150

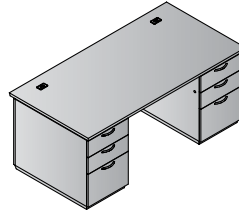

Double Pedestal Desk 66x30
TUXxxx-TYP3
 36.1 cu.ft. 337.3 lbs. **\$2,755**

Consists of (3 cartons):
TUX-02 66x30 Desk Set
 8.4 cu.ft. 99.2 lbs. \$665
TUX-63L Left BBF Pedestal
 13.9 cu.ft. 119 lbs. \$1,045
TUX-63R Right BBF Pedestal
 13.9 cu.ft. 119 lbs. \$1,045

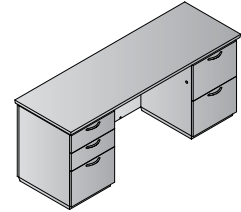

Double Pedestal Credenza 72x24
TUXxxx-TYP5
 32.6 cu.ft. 440.9 lbs. **\$2,595**

Consists of (3 cartons):
TUX-43 72x24 Credenza Set
 9.4 cu.ft. 233.7 lbs. \$745
TUX-66L Left BBF Return/Credenza Pedestal
 11.6 cu.ft. 114.6 lbs. \$925
TUX-75R Right FF Return/Credenza Pedestal
 11.6 cu.ft. 92.6 lbs. \$925

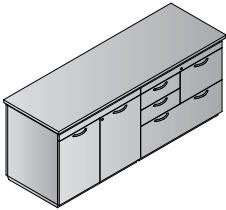

MultiFile/Storage Credenza 72x24
TUXxxx-TYP204
 50.3 cu.ft. 573.2 lbs. **\$3,510**

Consists of (3 cartons):
TUX-43 72x24 Credenza Set
 9.4 cu.ft. 233.7 lbs. \$745
TUX-69NT MultiFile Cabinet w/o Top
 20.2 cu.ft. 196.2 lbs. \$1,535
TUX-13NT 2-Door Storage Cabinet w/o Top
 20.7 cu.ft. 143.3 lbs. \$1,230

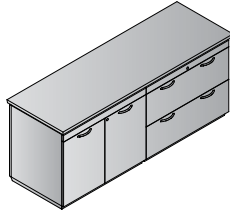

Lateral File/Storage Credenza 72x24
TUXxxx-TYP205
 50.3 cu.ft. 540.1 lbs. **\$3,450**

Consists of (3 cartons):
TUX-43 72x24 Credenza Set
 9.4 cu.ft. 233.7 lbs. \$745
TUX-12NT 2-Drawer Lateral File w/o Top
 20.2 cu.ft. 163.1 lbs. \$1,475
TUX-13NT 2-Door Storage Cabinet w/o Top
 20.7 cu.ft. 143.3 lbs. \$1,230

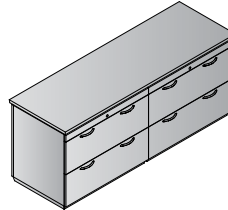

Double Lateral File Credenza 72x24
TUXxxx-TYP206
 49.9 cu.ft. 560 lbs. **\$3,695**

Consists of (3 cartons):
TUX-43 72x24 Credenza Set
 9.4 cu.ft. 233.7 lbs. \$745
TUX-12NT 2-Drawer Lateral File w/o Top
 20.2 cu.ft. 163.1 lbs. \$1,475
TUX-12NT 2-Drawer Lateral File w/o Top
 20.2 cu.ft. 163.1 lbs. \$1,475

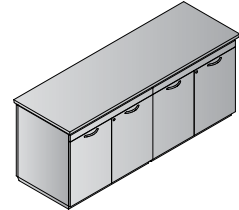

4-Door Storage Credenza 72x24
TUXxxx-TYP207
 50.7 cu.ft. 520.3 lbs. **\$3,205**

Consists of (3 cartons):
TUX-43 72x24 Credenza Set
 9.4 cu.ft. 233.7 lbs. \$745
TUX-13NT 2-Door Storage Cabinet w/o Top
 20.7 cu.ft. 143.3 lbs. \$925
TUX-13NT 2-Door Storage Cabinet w/o Top
 20.7 cu.ft. 143.3 lbs. \$1,230

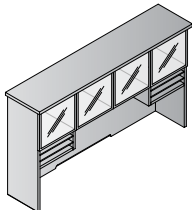

72" Hutch with Glass/Aluminum Doors 72x16x42H
TUXxxx-42
 15.7 cu.ft. 176.4 lbs. **\$1,965**

Consists of (2 cartons):
TUX-44H 72" Hutch w/o Doors
 13.6 cu.ft. 149.9 lbs. \$1,565
TUX-4DG Glass/Aluminum Doors (Set of 4)
 2.0 cu.ft. 26.5 lbs. \$400

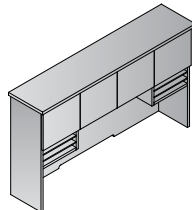

72" Hutch with Wood Doors 72x16x42H
TUXxxx-44
 15.7 cu.ft. 176.4 lbs. **\$1,745**

Consists of (2 cartons):
TUX-44H 72" Hutch w/o Doors
 13.6 cu.ft. 149.9 lbs. \$1,565
TUX-4DW Wood Doors (Set of 4)
 2.0 cu.ft. 26.5 lbs. \$180

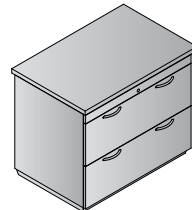

2-Drawer Lateral File 36x24x30H
TUX-12-xxx
 21.9 cu.ft. 163.1 lbs. **\$1,590**

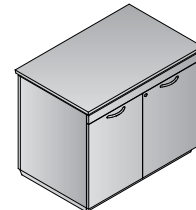

2-Door Storage Cabinet 36x24x30H
TUXxxx-13
 25.0 cu.ft. 213.8 lbs. **\$1,590**

Consists of (2 cartons):
TUX-13NT 2-Door Storage Cabinet w/o Top
 20.7 cu.ft. 143.3 lbs. \$1,230
TUX-169T 36x20x1H Top & Modesty Panel
 4.3 cu.ft. 70.5 lbs. \$360



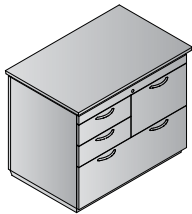

MultiFile Cabinet 36x24x30H
TUXxxx-69
 24.6 cu.ft. 266.8 lbs.

\$1,895

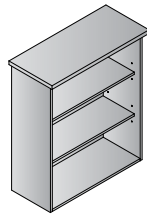

3-Shelf Bookcase/Open Hutch 36x16x42H
TUX-55-xxx
\$750

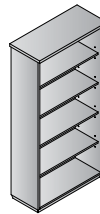

5-Shelf Bookcase 36x16x72H
TUX-56-xxx
 12.6 cu.ft. 176.4 lbs.
\$1,185

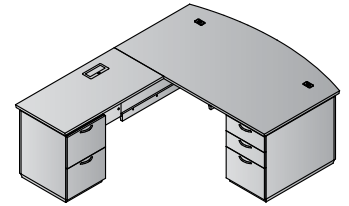

L-Shape w/Bow Front Desk + Left Return 72x90
TUXxxx-TYP8L
 48.9 cu.ft. 485 lbs.
\$3,885

Consists of (2 cartons):
TUX-69NT 36x20x29 MultiFile Cabinet w/o Top
 20.2 cu.ft. 196.2 lbs. \$1,535
TUX-169T 36x20x1H Top & Modesty Panel
 70.5 cu.ft. 4.3 lbs. \$360

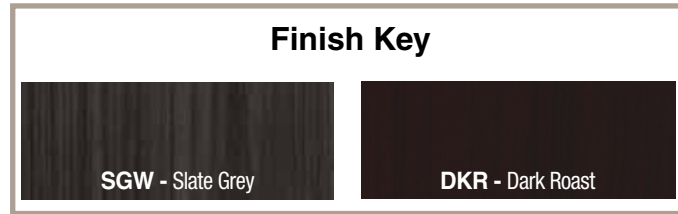

Consists of (5 cartons):
TUX-89 72x42 Bow Front Desk Set
 10.6 cu.ft. 127.9 lbs. \$860
TUX-65R Right BBF Pedestal
 16.4 cu.ft. 132.3 lbs. \$1,150
TUX-71L Left False Pedestal
 5.7 cu.ft. 52.9 lbs. \$450
TUX-45L 48x24 Left Return Set
 4.6 cu.ft. 79.4 lbs. \$500
TUX-75L Left FF Return/Credenza Pedestal
 11.6 cu.ft. 92.6 lbs. \$925

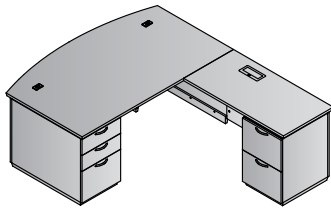

L-Shape w/Bow Front Desk + Right Return 72x90
TUXxxx-TYP8R **\$3,885**
 48.9 cu.ft. 485 lbs.

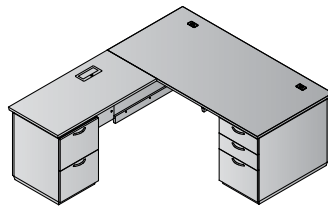

L-Shape w/Left Return 66x78
TUXxxx-TYP9L **\$3,575**
 44.1 cu.ft. 443.1 lbs.

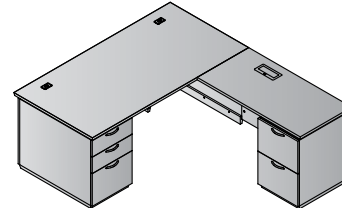

L-Shape w/Right Return 66x78
TUXxxx-TYP9R **\$3,575**
 44.1 cu.ft. 443.1 lbs.

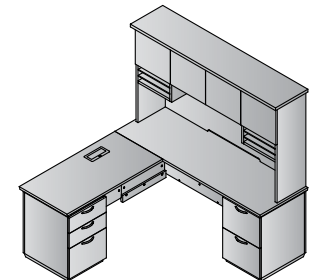

Left L + Hutch 72x72
TUXxxx-TYP231L **\$4,840**
 52.9 cu.ft. 696.7 lbs.

Consists of (5 cartons):
TUX-89 72x42 Bow Front Desk Set
 10.6 cu.ft. 127.9 lbs. \$860
TUX-65L Left BBF Pedestal
 16.4 cu.ft. 132.3 lbs. \$1,150
TUX-71R Right False Pedestal
 5.7 cu.ft. 52.9 lbs. \$450
TUX-45R 48x24 Right Return Set
 4.6 cu.ft. 79.4 lbs. \$500
TUX-75R Right FF Return/Credenza Pedestal
 11.6 cu.ft. 92.6 lbs. \$925

Consists of (5 cartons):
TUX-02 66x30 Desk Set
 8.4 cu.ft. 99.2 lbs. \$665
TUX-63R Right BBF Pedestal
 13.9 cu.ft. 119 lbs. \$1,045
TUX-67L Left False Pedestal
 5.7 cu.ft. 52.9 lbs. \$440
TUX-45L 48x24 Left Return Set
 4.6 cu.ft. 79.4 lbs. \$500
TUX-75L Left FF Return/Credenza Pedestal
 11.6 cu.ft. 92.6 lbs. \$925

Consists of (5 cartons):
TUX-02 66x30 Desk Set
 8.4 cu.ft. 99.2 lbs. \$665
TUX-63L Left BBF Pedestal
 13.9 cu.ft. 119 lbs. \$1,045
TUX-67R Right False Pedestal
 5.7 cu.ft. 52.9 lbs. \$440
TUX-45R 48x24 Right Return Set
 4.6 cu.ft. 79.4 lbs. \$500
TUX-75R Right FF Return/Credenza Pedestal
 11.6 cu.ft. 92.6 lbs. \$925

Consists of (6 cartons):
TUX-43 72x24 Credenza Set
 9.4 cu.ft. 233.7 lbs. \$745
TUX-75R Right FF Return/Credenza Pedestal
 11.6 cu.ft. 92.6 lbs. \$925
TUX-45L 48x24 Left Return Set
 4.6 cu.ft. 79.4 lbs. \$500
TUX-66L Left BBF Return/Credenza Pedestal
 11.6 cu.ft. 114.6 lbs. \$925
TUX-44H 72" Hutch w/o Doors
 13.6 cu.ft. 149.9 lbs. \$1,565
TUX-4DW Wood Doors (Set of 4)
 2.0 cu.ft. 26.5 lbs. \$180

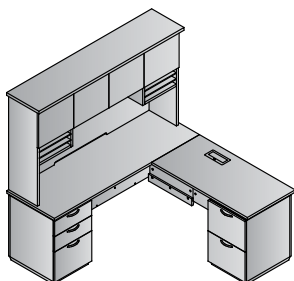

Right L + Hutch 72x72
TUXxxx-TYP231R **\$4,840**
 52.9 cu.ft. 696.7 lbs.

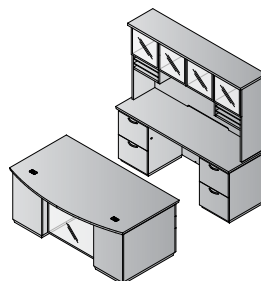

Double Pedestal Desk
TUXxxx-TYP11G **\$7,720**
 91.7 cu.ft. 987.7 lbs.

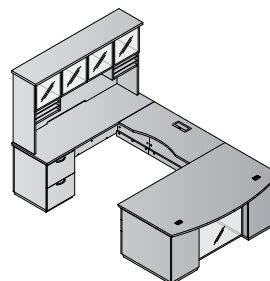

U-Shape w/Bridge on Left + Hutch 72x114
TUXxxx-TYP12LG **\$6,995**
 76.2 cu.ft. 892.9 lbs.

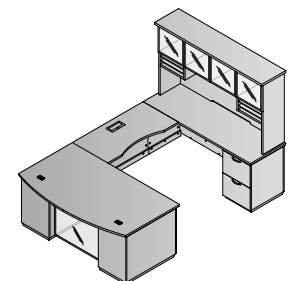

U-Shape w/Bridge on Right + Hutch 72x114
TUXxxx-TYP12RG **\$6,995**
 76.2 cu.ft. 892.9 lbs.

Consists of (6 cartons):
TUX-43 72x24 Credenza Set
 9.4 cu.ft. 233.7 lbs. \$745
TUX-66L Left BBF Return/Credenza Pedestal
 11.6 cu.ft. 114.6 lbs. \$925
TUX-45R 48x24 Right Return Set
 4.6 cu.ft. 79.4 lbs. \$500
TUX-75R Right FF Return/Credenza Pedestal
 11.6 cu.ft. 92.6 lbs. \$925
TUX-44H 72" Hutch w/o Doors
 13.6 cu.ft. 149.9 lbs. \$1,565
TUX-4DW Wood Doors (Set of 4)
 2.0 cu.ft. 26.5 lbs. \$180

Consists of (8 cartons):
TUX-89 72x42 Bow Front Desk Set
 10.6 cu.ft. 127.9 lbs. \$860
TUX-65L Left BBF Pedestal
 16.4 cu.ft. 132.3 lbs. \$1,150
TUX-65R Right BBF Pedestal
 16.4 cu.ft. 132.3 lbs. \$1,150
TUX-43 72x24 Credenza Set
 9.4 cu.ft. 233.7 lbs. \$745
TUX-75L Left FF Return/Credenza Pedestal
 11.6 cu.ft. 92.6 lbs. \$925
TUX-75R Right FF Return/Credenza Pedestal
 11.6 cu.ft. 92.6 lbs. \$925
TUX-44H 72" Hutch w/o Doors
 13.6 cu.ft. 149.9 lbs. \$1,565
TUX-4DG Glass/Aluminum Doors (Set of 4)
 2.0 cu.ft. 26.5 lbs. \$400

Consists of (8 cartons):
TUX-89 72x42 Bow Front Desk Set
 10.6 cu.ft. 127.9 lbs. \$860
TUX-65R Right BBF Pedestal
 16.4 cu.ft. 132.3 lbs. \$1,150
TUX-71L Left False Pedestal
 5.7 cu.ft. 52.9 lbs. \$450
TUX-70 48x24 Bridge
 6.8 cu.ft. 77.2 lbs. \$900
TUX-43 72x24 Credenza Set
 9.4 cu.ft. 233.7 lbs. \$745
TUX-75L Left FF Return/Credenza Pedestal
 11.6 cu.ft. 92.6 lbs. \$925
TUX-44H 72" Hutch w/o Doors
 13.6 cu.ft. 149.9 lbs. \$1,565
TUX-4DG Glass/Aluminum Doors (Set of 4)
 2.0 cu.ft. 26.5 lbs. \$400

Consists of (8 cartons):
TUX-89 72x42 Bow Front Desk Set
 10.6 cu.ft. 127.9 lbs. \$860
TUX-65L Left BBF Pedestal
 16.4 cu.ft. 132.3 lbs. \$1,150
TUX-71R Right False Pedestal
 5.7 cu.ft. 52.9 lbs. \$450
TUX-70 48x24 Bridge
 6.8 cu.ft. 77.2 lbs. \$900
TUX-43 72x24 Credenza Set
 9.4 cu.ft. 233.7 lbs. \$745
TUX-75R Right FF Return/Credenza Pedestal
 11.6 cu.ft. 92.6 lbs. \$925
TUX-44H 72" Hutch w/o Doors
 13.6 cu.ft. 149.9 lbs. \$1,565
TUX-4DG Glass/Aluminum Doors (Set of 4)
 2.0 cu.ft. 26.5 lbs. \$400

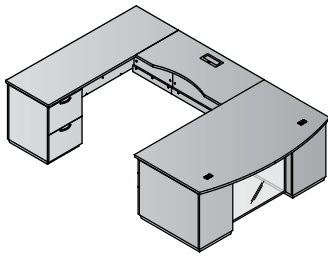

U-Shape w/Bridge on Left 72x114
TUXxxx-TYP22L **\$5,030**
 60.5 cu.ft. 716.5 lbs.

Consists of (6 cartons):
TUX-89 72x42 Bow Front Desk Set 10.6 cu.ft. 127.9 lbs. \$860
TUX-65R Right BBF Pedestal 16.4 cu.ft. 132.3 lbs. \$1,150
TUX-71L Left False Pedestal 5.7 cu.ft. 52.9 lbs. \$450
TUX-70 48x24 Bridge 6.8 cu.ft. 77.2 lbs. \$900
TUX-43 72x24 Credenza Set 9.4 cu.ft. 233.7 lbs. \$745
TUX-75L Left FF Return/Credenza Pedestal 11.6 cu.ft. 92.6 lbs. \$925

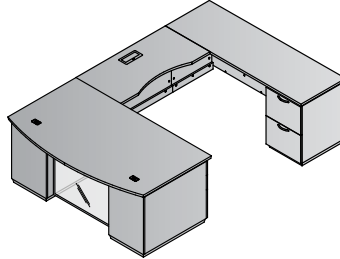

U-Shape w/Bridge on Right 72x114
TUXxxx-TYP22R **\$5,030**
 60.5 cu.ft. 716.5 lbs.

Consists of (6 cartons):
TUX-89 72x42 Bow Front Desk Set 10.6 cu.ft. 127.9 lbs. \$860
TUX-65L Left BBF Pedestal 16.4 cu.ft. 132.3 lbs. \$1,150
TUX-71R Right False Pedestal 5.7 cu.ft. 52.9 lbs. \$450
TUX-70 48x24 Bridge 6.8 cu.ft. 77.2 lbs. \$900
TUX-43 72x24 Credenza Set 9.4 cu.ft. 233.7 lbs. \$745
TUX-75R Right FF Return/Credenza Pedestal 11.6 cu.ft. 92.6 lbs. \$925

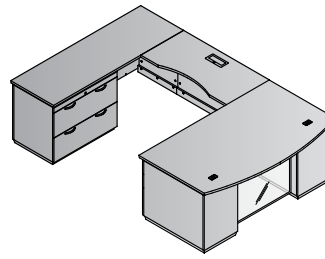

U-Shape w/Left Bridge+Lat. File Ped 72x114
TUXxxx-TYP52L **\$5,580**
 69.1 cu.ft. 787.1 lbs.

Consists of (6 cartons):
TUX-89 72x42 Bow Front Desk Set 10.6 cu.ft. 127.9 lbs. \$860
TUX-65R Right BBF Pedestal 16.4 cu.ft. 132.3 lbs. \$1,150
TUX-71L Left False Pedestal 5.7 cu.ft. 52.9 lbs. \$450
TUX-70 48x24 Bridge 6.8 cu.ft. 77.2 lbs. \$900
TUX-43 72x24 Credenza Set 9.4 cu.ft. 233.7 lbs. \$745
TUX-12NT 2-Drawer Lateral File w/o Top 20.2 cu.ft. 163.1 lbs. \$1,475

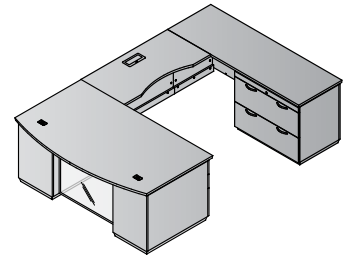

U-Shape w/Right Bridge+Lat. File Credenza Ped
TUXxxx-TYP52R **\$5,580**
 69.1 cu.ft. 787.1 lbs.

Consists of (6 cartons):
TUX-89 72x42 Bow Front Desk Set 10.6 cu.ft. 127.9 lbs. \$860
TUX-65L Left BBF Pedestal 16.4 cu.ft. 132.3 lbs. \$1,150
TUX-71R Right False Pedestal 5.7 cu.ft. 52.9 lbs. \$450
TUX-70 48x24 Bridge 6.8 cu.ft. 77.2 lbs. \$900
TUX-43 72x24 Credenza Set 9.4 cu.ft. 233.7 lbs. \$745
TUX-12NT 2-Drawer Lateral File w/o Top 20.2 cu.ft. 163.1 lbs. \$1,475

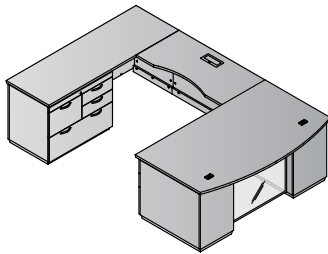

U-Shape w/Left Bridge+MultiFile Ped 72x114
TUXxxx-TYP53L **\$5,640**
 69.1 cu.ft. 820.1 lbs.

Consists of (6 cartons):
TUX-89 72x42 Bow Front Desk Set 10.6 cu.ft. 127.9 lbs. \$860
TUX-65R Right BBF Pedestal 16.4 cu.ft. 132.3 lbs. \$1,150
TUX-71L Left False Pedestal 5.7 cu.ft. 52.9 lbs. \$450
TUX-70 48x24 Bridge 6.8 cu.ft. 77.2 lbs. \$900
TUX-43 72x24 Credenza Set 9.4 cu.ft. 233.7 lbs. \$745
TUX-69NT MultiFile Cabinet w/o Top 20.2 cu.ft. 196.2 lbs. \$1,535

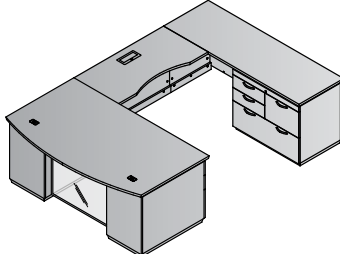

U-Shape w/Right Bridge+MultiFile Ped 72x114
TUXxxx-TYP53R **\$5,640**
 69.1 cu.ft. 820.1 lbs.

Consists of (6 cartons):
TUX-89 72x42 Bow Front Desk Set 10.6 cu.ft. 127.9 lbs. \$860
TUX-65L Left BBF Pedestal 16.4 cu.ft. 132.3 lbs. \$1,150
TUX-71R Right False Pedestal 5.7 cu.ft. 52.9 lbs. \$450
TUX-70 48x24 Bridge 6.8 cu.ft. 77.2 lbs. \$900
TUX-43 72x24 Credenza Set 9.4 cu.ft. 233.7 lbs. \$745
TUX-69NT MultiFile Cabinet w/o Top 20.2 cu.ft. 196.2 lbs. \$1,535

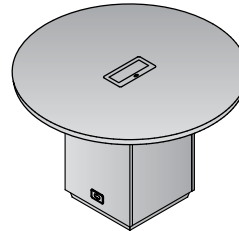

48" Round Table
TUXxxx-159 **\$1,315**
 15.6 cu.ft. 123.7 lbs.

Consists of (2 cartons):
TUX-159RT 48" Round Top 6.5 cu.ft. 62 lbs. \$795
TUX-5859B Base 9.1 cu.ft. 61.7 lbs. \$520

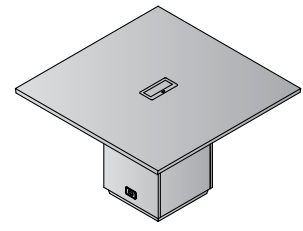

48" Square Table
TUXxxx-59 **\$1,315**
 15.6 cu.ft. 132.3 lbs.

Consists of (2 cartons):
TUX-59ST 48" Square Top 6.5 cu.ft. 70.5 lbs. \$795
TUX-5859B Base 9.1 cu.ft. 61.7 lbs. \$520

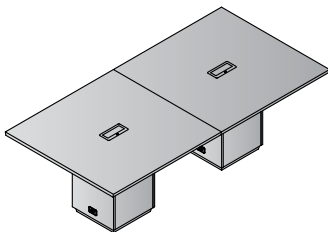

Rectangular Table 96x48x30H
TUXxxx-60 **\$2,630**
 31.2 cu.ft. 264.6 lbs.

Consists of (4 cartons):
TUX-59ST 48" Square Top 6.5 cu.ft. 70.5 lbs. \$795
TUX-59ST 48" Square Top 6.5 cu.ft. 70.5 lbs. \$795
TUX-5859B Base 9.1 cu.ft. 61.7 lbs. \$520
TUX-5859B Base 9.1 cu.ft. 61.7 lbs. \$520

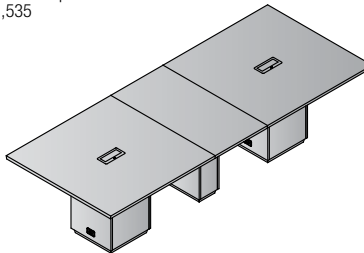

Rectangular Table 120x48x30H
TUXxxx-61 **\$3,280**
 43.0 cu.ft. 370.4 lbs.

Consists of (5 cartons):
TUX-59ST 48" Square Top 6.5 cu.ft. 70.5 lbs. \$795
TUX-59ST 48" Square Top 6.5 cu.ft. 70.5 lbs. \$795
TUX-59E 24" Extension Top/Base 11.8 cu.ft. 105.8 lbs. \$650
TUX-5859B Base 9.1 cu.ft. 61.7 lbs. \$520
TUX-5859B Base 9.1 cu.ft. 61.7 lbs. \$520

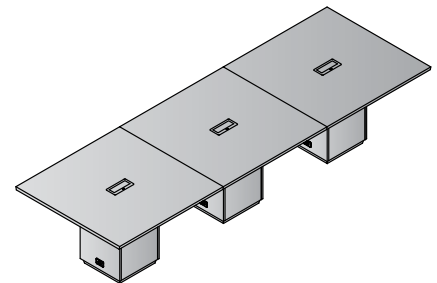

Rectangular Table 144x48x30H
TUXxxx-62 **\$3,945**
 46.8 cu.ft. 396.8 lbs.

Consists of (6 cartons):
TUX-59ST 48" Square Top 6.5 cu.ft. 70.5 lbs. \$795
TUX-59ST 48" Square Top 6.5 cu.ft. 70.5 lbs. \$795
TUX-59ST 48" Square Top 6.5 cu.ft. 70.5 lbs. \$795
TUX-59ST 48" Square Top 6.5 cu.ft. 70.5 lbs. \$795
TUX-5859B Base 9.1 cu.ft. 61.7 lbs. \$520
TUX-5859B Base 9.1 cu.ft. 61.7 lbs. \$520



Finish Key



All Napa items have achieved GREENGUARD Certification

STEPFRONT

 <p>NAP-201-xxx Desk Top/Modesty Set 71"x36"x29" CU:3.6 WT:90.4 List Price: \$430</p>	 <p>NAP-289-xxx Bow Top/Modesty Set 72"x40"x29" CU:4.2 WT:94.8 List Price: \$485</p>	 <p>NAP-200 Glass Modesty Panel for NAP201 & 289 Desk 40"x28"x1" CU:1.2 WT:35.3 List Price: \$235</p>	 <p>NAP-265-xxx 36" Deep Desk Pedestal Box/Box/File 15.5"x35.3"x28" CU:10.2 WT:90.4 List Price: \$760 <i>Ships Assembled</i></p>	 <p>NAP-271-xxx 36" Deep False Pedestal 15.5"x35.3"x28" CU:4.6 WT:39.7 List Price: \$310</p>	 <p>NAP-T265-xxx Top for NAP265 Pedestal (2-Pack) 15.6"x35.4"x1.1" CU:1.1 WT:17.6 List Price: \$175</p>	 <p>NAP-202-xxx Desk Top/Modesty Set 66"x30"x29" CU:2.8 WT:72.8 List Price: \$375</p>
 <p>NAP-263-xxx 30" Deep Pedestal Box/Box/File 15.5"x29.8"x28" CU:8.7 WT:86 List Price: \$705 <i>Ships Assembled</i></p>	 <p>NAP-267-xxx 30" Deep False Pedestal 15.5"x29.8"x28" CU:3.9 WT:35.3 List Price: \$285</p>	 <p>NAP-T263-xxx Top for NAP263 Pedestal (2-Pack) 15.6"x30"x1.1" CU:0.9 WT:15.4 List Price: \$155</p>				

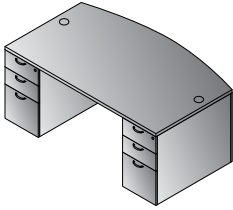

Bow Top Desk 71\"x40\"
NAPxxx-TYP201
 24.6 cu. ft. 275.6 lbs.
 Consists of: NAP-289,265 (2qty.)
\$2,005

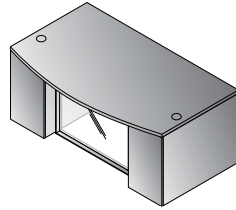

Bow Top Desk w/Glass Modesty Panel 71\"x40\"
NAPxxx-TYP201G
 25.8 cu. ft. 310.9 lbs.
 Consists of: NAP-289,200,265 (2qty.)
\$2,240

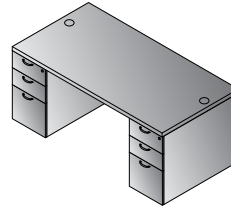

Double Pedestal Desk 71\"x36\"
NAPxxx-TYP202
 24 cu. ft. 271.2 lbs.
 Consists of: NAP-201,265 (2qty.)
\$1,950

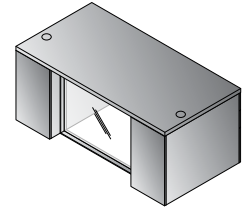

Double Pedestal Desk w/Glass Modesty Panel 71\"x36\"
NAPxxx-TYP202G
 25.3 cu. ft. 306.4 lbs.
 Consists of: NAP-201,200,265 (2qty.)
\$2,185

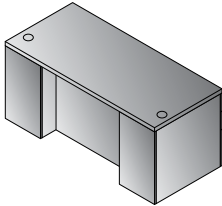

Double Pedestal Desk 66\"x30\"
NAPxxx-TYP203
 20.3 cu. ft. 244.7 lbs.
 Consists of: NAP-202,263 (2qty.)
\$1,785

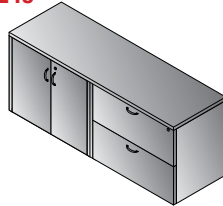

Combo Credenza 71\"x23\"
NAPxxx-TYP205
 21.5 cu. ft. 316.4 lbs.
 Consists of: NAP-T1213,12,13
\$1,655

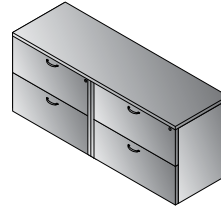

Double Lateral File Credenza 71\"x23\"
NAPxxx-TYP206
 32 cu. ft. 348.3 lbs.
 Consists of: NAP-T1213,12 (2qty.)
\$1,960

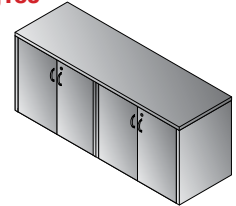

4-Door Storage Credenza 71\"x23\"
NAPxxx-TYP207
 10.9 cu. ft. 284.5 lbs.
 Consists of: NAP-T1213,13 (2qty.)
\$1,350

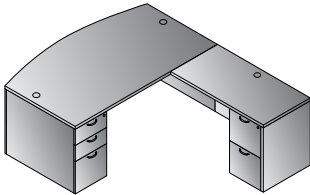

L-Shape w/Bow Top Desk 71\"x88\"
NAPxxx-TYP208
 29.7 cu. ft. 389.2 lbs.
 Consists of: NAP-289,265,271,45,74
\$2,515

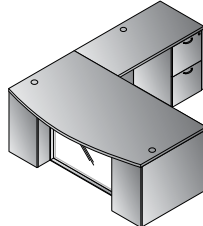

L-Shape w/Bow Top Desk and Glass Modesty Panel 71\"x88\"
NAPxxx-TYP208G
 30.9 cu. ft. 420.1 lbs.
 Consists of: NAP-289,200,265,271,45,74
\$2,750

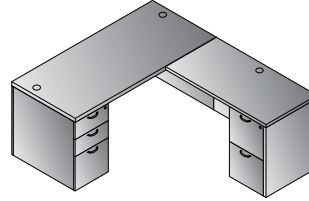

L-Shape 66\"x78\"
NAPxxx-TYP209
 26.2 cu. ft. 358.3 lbs.
 Consists of: NAP-202,263,267,45,74
\$2,325

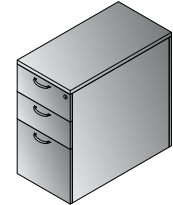

30\"D Freestanding Pedestal
NAPxxx-TYP263
 9.6 cu. ft. 101.4 lbs.
 Consists of: NAP-263,T263
\$860

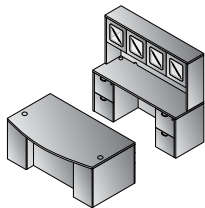

Executive Office
NAPxxx-TYP211
 49.5 cu. ft. 684.6 lbs.
 Consists of: NAP-289,265 (2qty.)
 43,74, (2qty.),41
 NAPxxx-41 consists of: NAP-44H,4DC
\$4,340

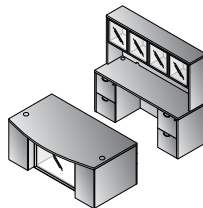

Executive Office w/Glass Modesty Panel
NAPxxx-TYP211G
 51 cu. ft. 719.9 lbs.
 Consists of: NAP-289,200,265 (2qty.)
 43,74, (2qty.),42
 NAPxxx-42 consists of: NAP-44H,4DG
\$4,590

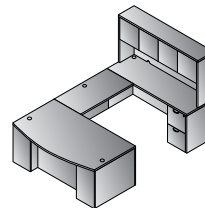

U-Shape with Hutch 71\"x112\"
NAPxxx-TYP212
 40 cu. ft. 631.8 lbs.
 Consists of: NAP-289,265,271
 70,43,74,44
 NAPxxx-44 consists of: NAP-44H,4DW
\$3,595

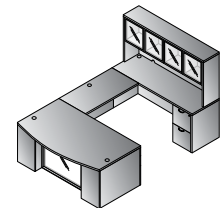

U-Shape w/Hutch & Glass Modesty Panel 71\"x112\"
NAPxxx-TYP212G
 41.5 cu. ft. 662.7 lbs.
 Consists of: NAP-289,200,265,271,
 70,43,74,42
 NAPxxx-42 consists of: NAP44H,4DG
\$3,895

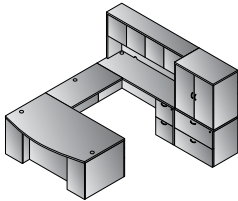

U-Shape w/Hutch + File Storage 107\"x112\"
NAPxxx-TYP213
 61 cu. ft. 936.1 lbs.
 Consists of: NAP-289,265,271,70,43,
 74,44,12,212DW
 NAPxxx-44 consists of: NAP-44H,4DW
 NAPxxx-212DW consists of: NAP-212H,2DW
\$5,285

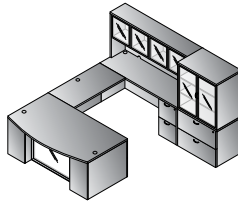

U-Shape w/Hutch + File Storage & Glass Modesty Panel 107\"x112\"
NAPxxx-TYP213G
 62.7 cu. ft. 968 lbs.
 Consists of: NAP-289,200,265,271
 70,43,74,42,12,212DG
 NAPxxx-42 consists of: NAP-44H,4DG
 NAPxxx-212DG consists of: NAP-212H,2DG
\$5,695

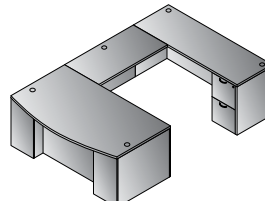

U-Shape 71\"x112\"
NAPxxx-TYP222
 34.0 cu. ft. 491.8 lbs.
 Consists of: NAP-289,265,271,70,43,74
\$2,885

Finish Key

CHY - Cherry
ESP - Espresso
MAH - Mahogany
URB - Urban Walnut
SGW - Slate Grey

MPL - Maple
 (see page 79 for Maple items
 stocked in NJ)

Modular laminate casegoods provide extensive selection, capability and value. Enter Napa in Cherry, Espresso, Mahogany, Maple and Urban Walnut wood grain laminates. Impact-resistant 3mm PVC edges feature wood grain design and tri-groove design detail. From executive and management offices to task environments and high-density areas, Napa excels for today's businesses. Napa complies with ANSI/BIFMA standards.



All Napa items have achieved GREENGUARD Certification

Finish Key

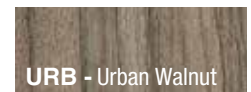
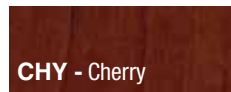
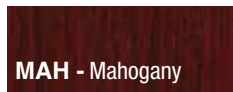
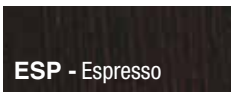

DESKS

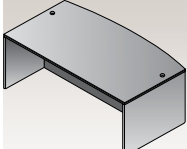
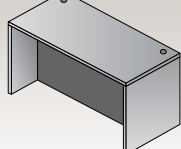
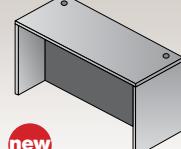
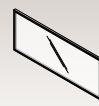
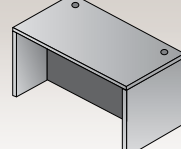
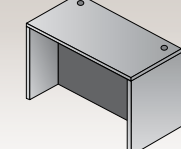
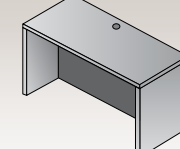
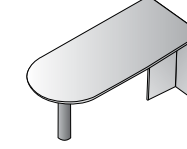
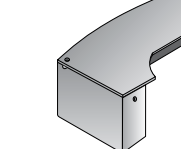
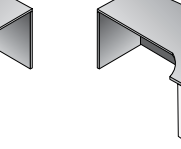
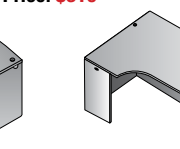
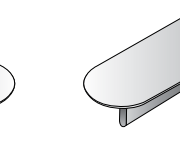
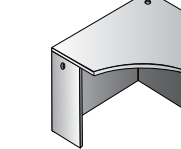
 NAP-89-xxx Bow Desk Shell 71"x41"x29" CU:7.3 WT:173.1 List Price: \$710	 NAP-01-xxx Desk Shell 70.5"x36.5"x29" CU:6.4 WT:162.0 List Price: \$615	 NAP-101-xxx Desk Shell 70.5"x30"x29" CU:5.3 WT:121.0 List Price: \$565	 NAP-88 Glass Modesty Panel Fits NAP01, NAP82L, NAP82R, NAP89 69"x28"x1" CU:2.1 WT:56.2 Use: NAP85 & NAP 86 Pedestals List Price: \$310	 NAP-02-xxx Desk Shell 66"x30"x29" CU:5.1 WT:135.6 List Price: \$510	 NAP-03-xxx Desk Shell 60"x30"x29" CU:4.6 WT:127.9 List Price: \$485	 NAP-21-xxx Desk Shell 48"x30"x29" CU:4.8 WT:110.2 List Price: \$470
 NAPxxx-47 Bullet 71"x36"x29" CU:6.6 WT:116.8 Consists of: NAP-47T,47PBLK List Price: \$625	 NAP-87TL-xxx Left Corner Desk 71"x30"/48"x29" CU:8.4 WT:184.1 List Price: \$815	 NAP-87TR-xxx Right Corner Desk 71"x30"/48"x29" CU:8.4 WT:184.1 List Price: \$815	 NAPxxx-57L Left Computer Corner Bullet 71"x30"/42"x29" CU:8.2 WT:145.5 Consists of: NAP57TL,57PBLK List Price: \$795	 NAPxxx-57R Right Computer Corner Bullet 71"x30"/42"x29" CU:8.2 WT:145.5 Consists of: NAP57TR,57PBLK List Price: \$795	 NAP-83-xxx Corner Unit 42"x42"x29" CU:5.0 WT:125.7 List Price: \$500	

RETURNS

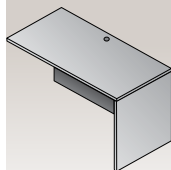
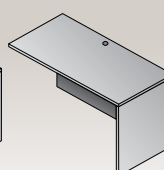
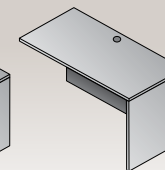
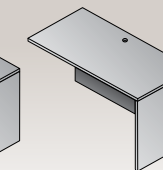
 NAP-45-xxx Return Shell 47"x23.5"x29" CU:3.8 WT:90.4 List Price: \$400	 NAP-96-xxx Return Shell 42"x23.5"x29" CU:3.2 WT:81.0 List Price: \$365	 NAP-46-xxx Return Shell 42"x20"x29" CU:3.4 WT:88.2 List Price: \$335 <i>**Use with NAP76 Ped</i>	 NAP-92-xxx Return Shell 36"x23.5"x29" CU:2.9 WT:73.9 List Price: \$315
-----------------------------------------------------------------------------------------------------------------------------------------------------------------------------------------	-----------------------------------------------------------------------------------------------------------------------------------------------------------------------------------------	----------------------------------------------------------------------------------------------------------------------------------------------------------------------------------------------------------------------	-----------------------------------------------------------------------------------------------------------------------------------------------------------------------------------------

BRIDGES

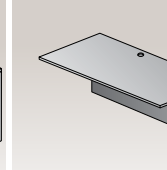
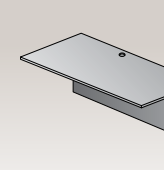
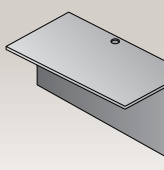
 NAP-70-xxx Bridge 47"x23.5"x29" CU:2.8 WT:70.5 List Price: \$315	 NAP-98-xxx Bridge 42"x23.5"x29" CU:2.5 WT:63 List Price: \$295	 NAP-93-xxx Bridge 35"x23.5"x29" CU:2.2 WT:56.2 List Price: \$260
-----------------------------------------------------------------------------------------------------------------------------------------------------------------------------------	-----------------------------------------------------------------------------------------------------------------------------------------------------------------------------------	-------------------------------------------------------------------------------------------------------------------------------------------------------------------------------------

CREDENZAS

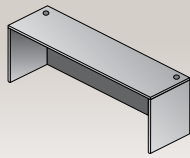

NAP-43-xxx
Credenza Shell
71"x24"x29"
CU:5.1 WT:122.4
List Price: \$455

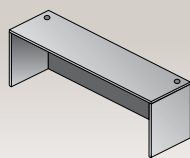

NAP-11-xxx
Credenza Shell
66"x24"x29"
CU:4.6 WT:116.6
List Price: \$425

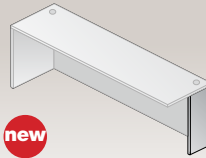

NAP-SL2-xxx
Support Leg (2-pack)
11"x28"H
CU:0.8 WT:9.0
List Price: \$120

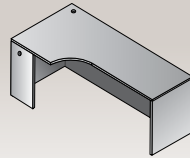

NAP-82L-xxx
Left Corner Credenza
71"x36"x29"
CU:6.4 WT:148.8
List Price: \$660

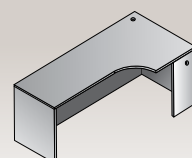

NAP-82R-xxx
Right Corner Credenza
71"x36"x29"
CU:6.4 WT:148.8
List Price: \$660

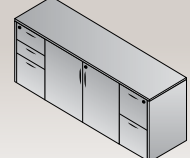

NAPxxx-110
Storage Credenza
72"x22"x29"
CU:16.7 WT:224
Consists of:
NAP-110A,110B
List Price: \$1815

PEDESTALS

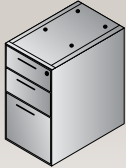

NAP-65-xxx
BBF Ped
15.5"x22"x28"
CU:7.0 WT:78.3
List Price: \$595
Ships Assembled

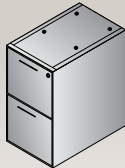

NAP-74-xxx
FF Ped
15.5"x22"x28"
CU:7.0 WT:73.9
List Price: \$560
Ships Assembled

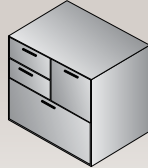

NAP-69-xxx
MultiFile Ped
31"x22"x29"
CU:13.6 WT:154.3
List Price: \$1115
Ships Assembled



NAP-85-xxx
Mobile BBF Ped
14"x22"x27H"
CU:7.0 WT:73.9
List Price: \$785
Ships Assembled, except casters

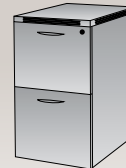

NAP-86-xxx
Mobil FF Ped
14"x22"x27H"
CU:7.0 WT:73.9
List Price: \$785
Ships Assembled, except casters

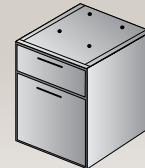

NAP-76-xxx
Hanging Ped-20" Return
15.5"x18.5"x21"
CU:4.5 WT:50.7
List Price: \$455
Ships Assembled
Use with NAP46

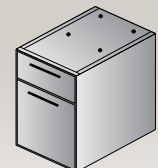

NAP-80-xxx
Hanging BF Ped
15.5"x22"x21"
CU:5.3 WT:60.6
List Price: \$455
Ships Assembled

STORAGE & FILING

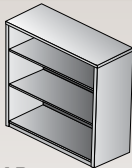

NAP-55-xxx
3-Shelf Bookcase
36"x14"x42"
CU:4.4 WT:98.1
List Price: \$455

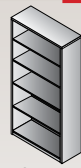

NAP-56-xxx
5-Shelf Bookcase
36"x14"x65"
CU:6.8 WT:149.9
List Price: \$625

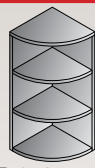

NAP-253-xxx
36" H Quarter-Round
Open Hutch 15Wx15D
15"x15"x36"
CU:1.7 WT:41.9
List Price: \$295

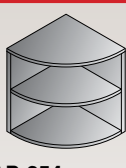

NAP-254-xxx
29" H Quarter-Round
Bookcase 24Wx24D
24"x24"x29"
CU:2.5 WT:61.7
List Price: \$375

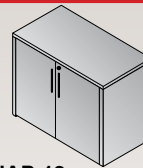

NAP-13-xxx
Storage Cabinet
36"x22"x29"
CU:5.5 WT:117.9
List Price: \$555

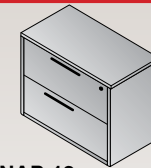

NAP-12-xxx
Lateral File
36"x22"x29"
CU:15.5 WT:149.9
List Price: \$860
Ships Assembled

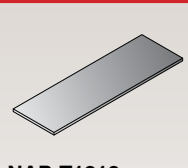

NAP-T1213-xxx
NAP12/13 Combo Top
71"x22.5"
CU:0.9 WT:48.5
List Price: \$240



NAP-109-xxx
Four-Drawer
Lateral File
36"x22"x56"
CU:28.5 WT:235
List Price: \$1985
Ships Assembled



NAP-152-xxx
Storage Cabinet
22.5"x24"x65"
CU:23.5 WT:186.6
List Price: \$1525
Ships Assembled

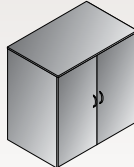

NAPxxx-212DW
37" H Storage Cabinet
w/Wood Doors
36"x22"x37"
CU:5.5 WT:154.3
Consists of:
NAP-212H,2DW
List Price: \$830
Use Freestanding or w/NAP12

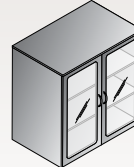

NAPxxx-212DC
37" H Storage Cabinet
w/Glass/Wood Doors
36"x22"x37"
CU:5.7 WT:155.4
Consists of:
NAP-212H,2DC
List Price: \$885
Use Freestanding or with NAP12

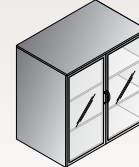

NAPxxx-212DG
37" H Storage Cabinet
w/Glass/Alum. Doors
36"x22"x37"
CU:5.7 WT:155.4
Consists of:
NAP-212H,2DG
List Price: \$940
Use Freestanding or with NAP12

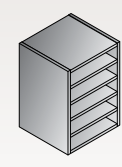

NAP-VO-BLK
Vertical Organizer,
Black
12.5"x12.5"x18.5"
CU:0.8 WT:26.5
List Price: \$150

HUTCHES

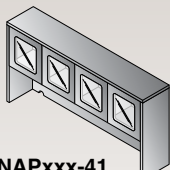

NAPxxx-41
Overhead with Wood/
Glass Doors
71"x15"x36"
CU:6.3 WT:140
Consists of:
NAP-44H,4DC
List Price: \$760

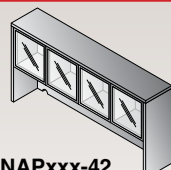

NAPxxx-42
Overhead with Glass
Doors
71"x15"x36"
CU:6.5 WT:136
Consists of:
NAP-44H,4DG
List Price: \$775

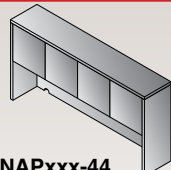

NAPxxx-44
Overhead Storage
71"x15"x36"
CU:6.2 WT:141.0
Consists of:
NAP-44H,4DW
List Price: \$710

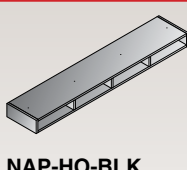

NAP-HO-BLK
Horizontal Organizer,
Black
Fits NAP41, 42 &44
68.7"x13"x5"
CU:3.3 WT:38.6
Ships Assembled
List Price: \$240

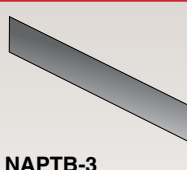

NAPTb-3
Tackboard for NAP42/44
SON44, KEN42/44
65"x17.5"
Black Fabric
CU:1.2 WT:15
List Price: \$195



Tackboard
Custom Fabric
NAPTb_____
(Specify Fabric)
Grade A \$250
Grade B \$280
Grade C \$310
Grade R \$340

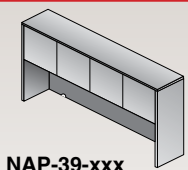

NAP-39-xxx
Overhead Storage
66"x15"x36"
CU:5.7 WT:132.0
List Price: \$615

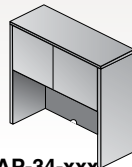

NAP-34-xxx
Hutch with Doors
48"x15"x36"
CU:4.2 WT:101.4
List Price: \$535

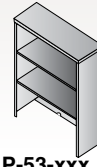

NAP-53-xxx
Open Hutch
36"x14"x36"
CU:3.9 WT:81.6
List Price: \$375

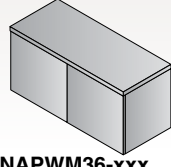

NAPWM36-xxx
Wall-Mount Overhead
36"x15"x17"
CU:6.7 WT:55
List Price: \$425
Ships Assembled

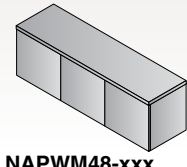

NAPWM48-xxx
Wall-Mount Overhead
48"x15"x17"
CU:8.8 WT:70.4
List Price: \$535
Ships Assembled

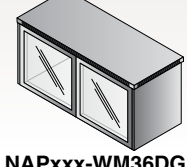

NAPxxx-WM36DG
Wall-Mount Overhead
with Glass Doors
36"x15"x17"
CU:2.2 WT:54
Consists of:
NAPWM36H,NAPWMDG
List Price: \$460

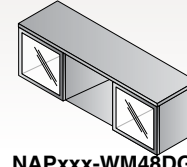

NAPxxx-WM48DG
Wall-Mount Overhead
with Glass Doors
48"x15"x17"
CU:2.7 WT:72
Consists of:
NAPWM48H,NAPWMDG
List Price: \$565

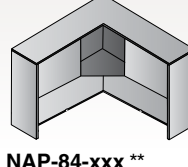

NAP-84-xxx **
Corner Hutch
42"x42"x36"
CU:7.1 WT:142.2
List Price: \$725
Not Available in
Slate Grey

RECEPTION

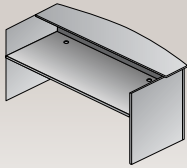

NAP-122-xxx
Reception Desk Shell
71"x30"/36"x42"
CU:8.3 WT:207.2
List Price: \$850

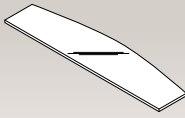

NAP-123
Glass Floating Top
Fits NAP122
71"x17.5"x0.5"
CU:2.1 WT:79.4
List Price: \$495

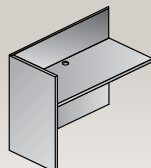

NAP-125-xxx
Reception Return
Shell
42"x24"x41"
CU:4.1 WT:100.3
List Price: \$430

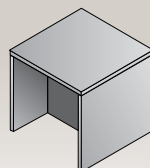

NAP-20-xxx
End Table
24"x24"x20"
CU:2.0 WT:49.6
List Price: \$315

ACCESSORIES

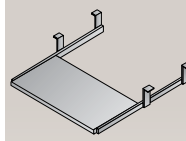

NAP-14-xxx
Keyboard Tray
26"x12"
CU:0.6 WT:13.2
List Price: \$90

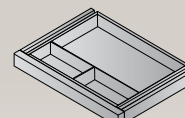

NAP-15-xxx
Center Drawer
20"x15"
CU:0.8 WT:8.8
List Price: \$90

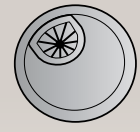

NAP-GM
Metallic Grommets
(5-Pack)
2.5"x2.5"x1"
CU:0.02 WT:0.05
List Price: \$95

CONFERENCE

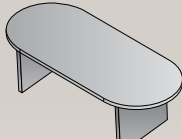

NAP-35-xxx
Conference Table
71"x35"x29"
CU:6.7 WT:138.9
List Price: \$690

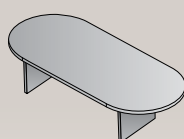

NAP-36-xxx
Conference Table
95"x44"x29"
CU:10.8 WT:189.6
List Price: \$895

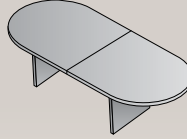

NAPxxx-37
Conference Table
120"x48"x29"
CU:11.3 WT:246.9
Consists of:
NAP-37T,37S
List Price: \$1225
Not Available in Maple

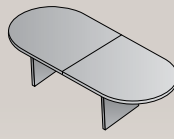

NAPxxx-38
Conference Table
144"x48"x29"
CU: 14.2 WT: 321.2
Consists of:
NAP-38T,38S
List Price: \$1945

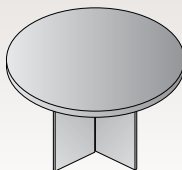

NAP-23-xxx
Round Table
47"Dia.x29"H
CU:6.8 WT:109.1
List Price: \$690

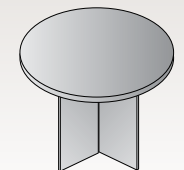

NAP-27-xxx
Round Table
42"Dia.x29"H
CU:5.4 WT:94.8
List Price: \$595



NAPxxx-33
36" Round Table
Black Metal Base
36"Dia.x29"H
CU:3.1 WT:58.4
Consists of:
NAP-33T,33B
List Price: \$480

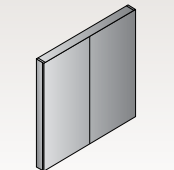

NAP-100-xxx
Presentation Board
48"x48"
CU:8.5 WT:101.4
List Price: \$735
Ships Assembled

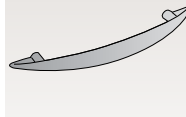

NAP-PM
Metallic Drawer Pulls
(10-Pack)
4"x1"x0.5"
CU:0.005 WT:0.01
List Price: \$95

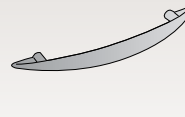

NAP-PB
Black Drawer Pulls
(10-Pack)
4"x1"x0.5"
CU:0.005 WT:0.01
List Price: \$90



LK1-GC
Lock Core with Keys
\$15 List
KC-GC Change Key
\$8 List
KM-GC Master Key
\$8 List



Napa Desk Riser 35" x 29" List Price: \$775



TAA Compliant

35.5"W x 29"D x 16.75"H (Use on 30" or deeper work surfaces)
4.7 cu.ft. 68 lbs. Carton: 38L x 31W x 7H

- 16.75" adjustment range
- 10 position height adjustment
- Dual handles
- Spring-assist lift
- Supports up to 33 lbs.
- Work surface: 35"W x 20"D
- Keyboard platform: 26"W x 13"D
- No assembly required
- Patent No. US 9,681,746



NAP3529-CHY Cherry



NAP3529-MAH Mahogany



NAP3529-ESP Espresso



NAP3529-URB Urban Walnut





new

SGW - Slate Grey

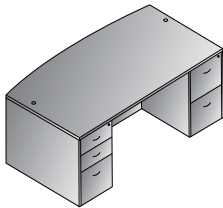

Bow Top Desk 71"x41"
NAPxxx-TYP1
21.3 cu. ft. 325.3 lbs.
Consists of: NAP-89,65,74
\$1,865

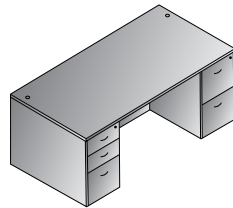

Double Pedestal Desk 71"x35"
NAPxxx-TYP2
20.4 cu. ft. 314.2 lbs.
Consists of: NAP-01,65,74
\$1,770

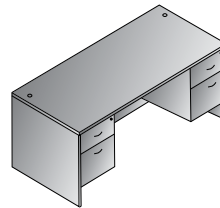

Double Pedestal Desk 66"x30"
NAPxxx-TYP3
15.7 cu. ft. 256.8 lbs.
Consists of: NAP-02,80,80
\$1,420

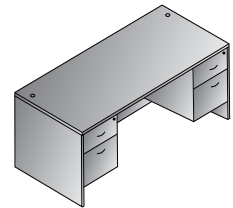

Double Pedestal Desk 60"x30"
NAPxxx-TYP4
15.2 cu. ft. 249.1 lbs.
Consists of: NAP-03,80,80
\$1,395

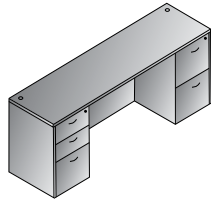

Kneespace Credenza 72"x24"
NAPxxx-TYP5
19.1 cu. ft. 274.6 lbs.
Consists of: NAP-43,65,74
\$1,610

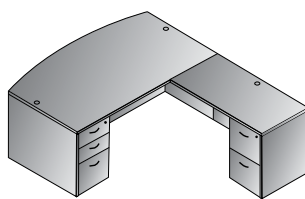

L Shape w/Bow Top Desk 71"x89"
NAPxxx-TYP8
25.1 cu. ft. 415.7 lbs.
Consists of: NAP-89,65,45,74
\$2,265

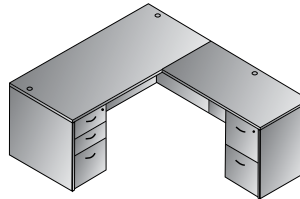

L Shape 66"x78"
NAPxxx-TYP9
22.9 cu. ft. 378.2 lbs.
Consists of: NAP-02,65,45,74
\$2,065

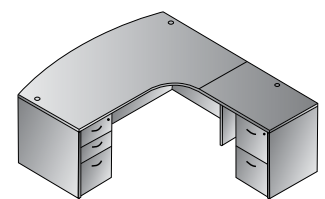

Right L Shape w/Curved Corner
71"x83"
NAPxxx-TYP10R
25.3 cu. ft. 410.2 lbs.
Consists of: NAP-87R,65,92,74
\$2,285

Casegoods IN STOCK

All Napa items have achieved GREENGUARD Certification

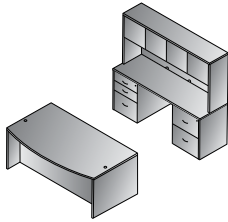

Executive Office
NAPxxx-TYP11
 47.3 cu. ft. 739.9 lbs.
 Consists of: NAP-89,65,74,43, 65,74,44
 NAP-44 consists of: NAP-44H,4DW
\$4,185

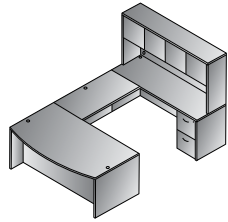

U Shape w/Hutch 71"x113"
NAPxxx-TYP12
 36.1 cu. ft. 658.2 lbs.
 Consists of: NAP-89,65,70,43, 74,44
 NAP-44 consists of: NAP-44H,4DW
\$3,345

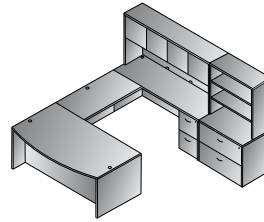

U Shape w/Hutch + Storage
 108"x113"
NAPxxx-TYP13
 55.5 cu. ft. 889.7 lbs.
 Consists of: NAP-89,65,70,43,74,44,12,53
 NAP-44 consists of: NAP-44H,4DW
\$4,580

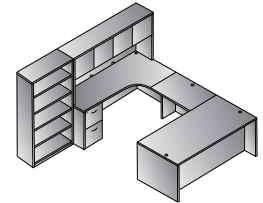

Left U + Bookcase 107"x107"
NAPxxx-TYP14L
 42.7 cu. ft. 809.1 lbs.
 Consists of: NAP-01,65,93, 82R,74,44,56
 NAP-44 consists of: NAP-44H,4DW
\$4,025

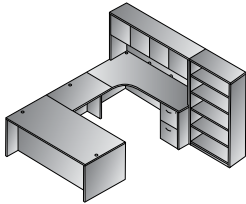

Right U + Bookcase 107"x107"
NAPxxx-TYP14R
 42.7 cu. ft. 809.1 lbs.
 Consists of: NAP-01,65,93, 82L,74,44,56
 NAP-44 consists of: NAP-44H,4DW
\$4,025

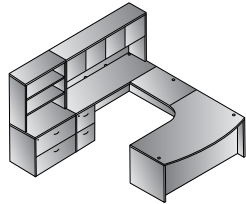

Left U w/Corner + Storage 107"x107"
NAPxxx-TYP15L
 56.0 cu. ft. 886.4 lbs.
 Consists of: NAP-87L,65,93,43,74,44,12,53
 NAP-44 consists of: NAP-44H,4DW
\$4,630

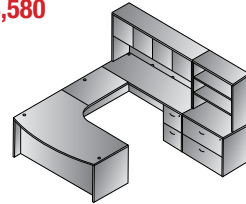

Right U w/Corner + Storage 107"x107"
NAPxxx-TYP15R
 56.0 cu. ft. 886.4 lbs.
 Consists of: NAP-87R,65,93,43, 74,44,12,53
 NAP-44 consists of: NAP-44H,4DW
\$4,630

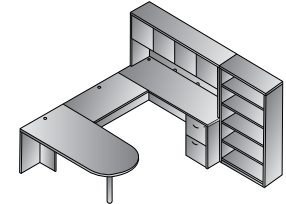

U w/Bullet + Bookcase 107"x108"
NAPxxx-TYP16
 35.2 cu. ft. 673.5 lbs.
 Consists of: NAP-47,70,43, 74,44,56
 NAP-44 consists of: NAP-44H,4DW
 NAP-47 consists of: NAP-47T,47PBLK
\$3,290

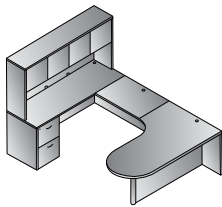

U w/Left Corner Bullet 71"x101"
NAPxxx-TYP18L
 29.4 cu. ft. 538 lbs.
 Consists of: NAP-57L,93,43,74,44
 NAP-44 consists of: NAP-44H,4DW
 NAP-57L consists of: NAP-57TL,57PBLK
\$2,780

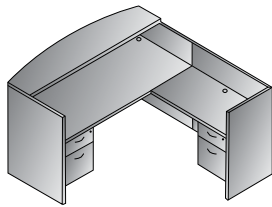

Reception Station 71"x77"x42"H
NAPxxx-TYP19
 22.2 cu. ft. 418.8 lbs.
 Consists of: NAP-122,80,125,76
\$2,190

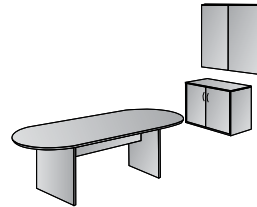

Conference Group 3-Pcs.
NAPxxx-TYP20
 24.8 cu. ft. 408.9 lbs.
 Consists of: NAP-36,13,100
\$2,185

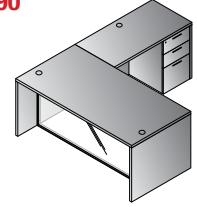

L-Shape w/Glass Modesty Panel
 71"x84"
NAPxxx-TYP29G
 19.3 cu. ft. 386.9 lbs.
 Consists of: NAP-01,45,65,88
\$1,920



NAPA MAPLE
 IN STOCK NEW JERSEY ONLY

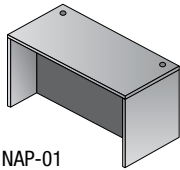

NAP-01

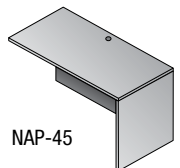

NAP-45

Desk Shells
 NAP-01 71"x36"..... **\$615**
 NAP-02 66"x30"..... **\$510**
 NAP-03 60"x30"..... **\$485**
 NAP-21 48"x30"..... **\$470**
 NAP-89 71"x41"
 Bow Front..... **\$710**

Returns
 NAP-45 48"x24"..... **\$400**
 NAP-96 42"x24"..... **\$365**
 NAP-46 42"x20"..... **\$335**
 ** Use NAP76 Pedestal

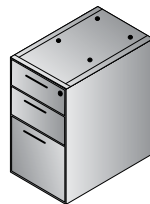

NAP-65-MPL
 BBF Ped
\$595

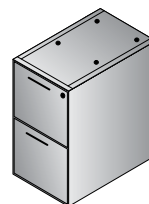

NAP-74-MPL
 FF Ped
\$560

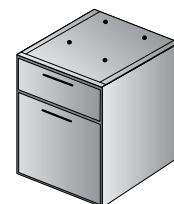

NAP-76-MPL
 Hanging
 Ped-20" Return
\$455
 Use with NAP46

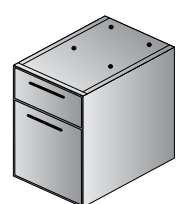

NAP-80-MPL
 Hanging BF Ped
\$455

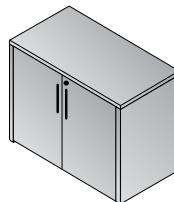

NAP-13-MPL
 Storage
 Cabinet
\$555

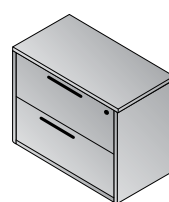

NAP-12-MPL
 Lateral File
\$860

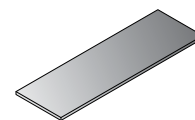

NAP-T1213-MPL
 NAP12/13
 Combo Top
\$240

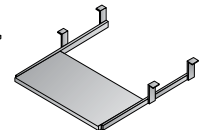

NAP-14-MPL
 Keyboard Tray
\$90



Lodi combines open, contemporary appearance and modern quality details with space-saving, budget-saving solutions. The ¾ modesty panels provide easy access to wall outlets. Full-width cord-drop on all hutches for cord management. New 60" wide desk, credenza and open overhead for compact offices. New laminate frame/glass doors for Lodi/Napa 72" overheads. The new contemporary, clean-grain design Urban Walnut features an embossed wood-like finish. Cherry and Espresso match Napa laminates for mix/match opportunities.

Finish Key

-  **ESP**
- Espresso
-  **URB**
- Urban Walnut
-  **CHY**
- Cherry
-  **CNC**
- Cognac

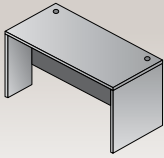
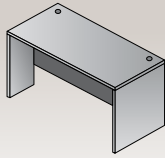
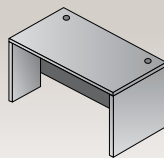
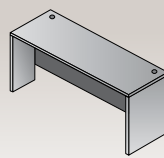
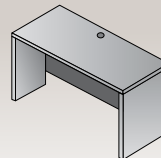

DESKS

- | | | | | |
|---------------------------------------------------------------------------------------------|------------------------------------------------------------------------------------------------|-----------------------------------------------------------------------------------------------|----------------------------------------------------------------------------------------------|--------------------------------------------------------------------------------------------|
|  |  |  |  |  |
| LOD-01-xxx
Desk Shell
71"x35"x29"
CU:4.2 WT:121
List Price: \$515 | LOD-101-xxx
Desk Shell
71"x30"x29"
CU:3.8 WT:107.8
List Price: \$490 | LOD-02-xxx
Desk Shell
66"x30"x29"
CU:3.3 WT:101.2
List Price: \$445 | LOD-03-xxx
Desk Shell
60"x30"x29"
CU:3.0 WT:94.6
List Price: \$415 | LOD-22-xxx
Desk Shell
45"x24"x29"
CU:2.3 WT:66
List Price: \$315 |

RETURNS

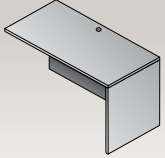
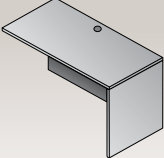
- | | |
|------------------------------------------------------------------------------------------------|------------------------------------------------------------------------------------------------|
|  |  |
| LOD-45-xxx
Return Shell
48"x24"x29"
CU:1.6 WT:57.2
List Price: \$300 | LOD-46-xxx
Return Shell
42"x20"x29"
CU:1.5 WT:46.2
List Price: \$250 |

BRIDGES

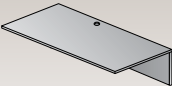
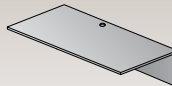
- | | |
|------------------------------------------------------------------------------------------|----------------------------------------------------------------------------------------------------------------|
|  |  |
| LOD-70-xxx
Bridge
48"x24"x29"
CU:1.6 WT:46.2
List Price: \$235 | LOD-71-xxx
Bridge
42"x20"x29"
CU:1.2 WT:37.4
List Price: \$195
<i>*Phase Out*</i> |

CREDENZAS

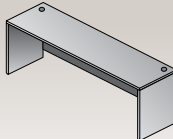
- | |
|--------------------------------------------------------------------------------------------------|
|  |
| LOD-43-xxx
Credenza Shell
71"x20"x29"
CU:2.4 WT:77.0
List Price: \$350 |

STORAGE & FILING

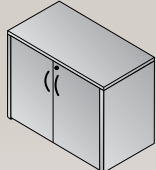
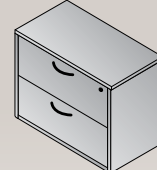
- | | |
|-------------------------------------------------------------------------------------------------------------|----------------------------------------------------------------------------------------------------------------------------|
|  |  |
| LOD-13-xxx
2-Door
Storage Cabinet
30"x20"x29"
CU:3.3 WT:80.3
List Price: \$420 | LOD-12-xxx
Lateral File
30"x20"x29"
CU:11.4 WT:103.4
List Price: \$805
<i>Ships Assembled</i> |

PEDESTAL

- | |
|-----------------------------------------------------------------------------------------------------------------------------------------------|
|  |
| LOD-76-xxx
Box File Hanging
Pedestal
15.5"x17.75"x18"
CU:3.5 WT:35.2
List Price: \$320
<i>Ships Assembled</i> |

HUTCHES

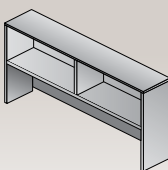
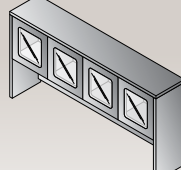
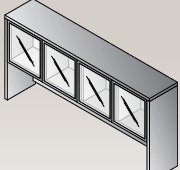
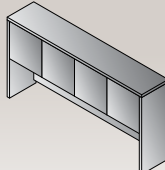
- | | | | |
|------------------------------------------------------------------------------------------------------------------------------------------------------------------------|---------------------------------------------------------------------------------------------------------------------------------------------------------|---------------------------------------------------------------------------------------------------------------------------------------------------------------|--------------------------------------------------------------------------------------------------------------------------------------------------|
|  |  |  |  |
| LOD-09-xxx
Open Overhead
(without Doors)
60"x14"x36"
CU:3.3 WT:83.6
List Price: \$395
<i>*Phase Out*</i>
CHY & ESP
not available | LODxxx-41
Overhead with Wood/
Glass Doors
71"x14"x36"
CU:4.9 WT:118
Consists of:
LOD-44H & NAP-4DC
List Price: \$735 | LODxxx-42
Overhead with
Aluminum/Glass
Doors
71"x14"x36"
CU:5.1 WT:114
Consists of:
LOD-44H & NAP-4DG
List Price: \$750 | LODxxx-44
Overhead with
Wood Doors
71"x14"x36"
CU:4.8 WT:119
Consists of:
LOD-44H & NAP-4DW
List Price: \$685 |

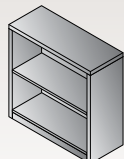
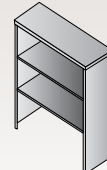
- | | |
|----------------------------------------------------------------------------------------------------|----------------------------------------------------------------------------------------------|
|  |  |
| LOD-55-xxx
2-Shelf Bookcase
30"x12"x36"
CU:1.8 WT:50.6
List Price: \$350 | LOD-53-xxx
Open Hutch
30"x12"x36"
CU:1.8 WT:55.0
List Price: \$275 |

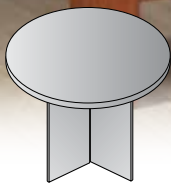

NAP-27-CHY
NAP-27-ESP
NAP-27-URB
LOD-27-CNC
 Round Table
 42" Dia. x 29"H
 CU: 5.4 WT: 94.8
List Price: \$595

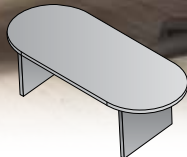

NAP-35-CHY
NAP-35-ESP
NAP-35-URB
LOD-35-CNC
 Conference Table
 71" x 35" x 29"
 CU: 6.7 WT: 138.9
List Price: \$690

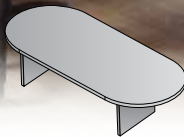

NAP-36-CHY
NAP-36-ESP
NAP-36-URB
LOD-36-CNC
 Conference Table
 95" x 44" x 29"
 CU: 10.8 WT: 189.6
List Price: \$895

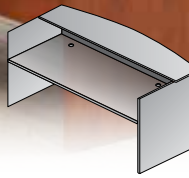

NAP-122-CHY
NAP-122-ESP
NAP-122-URB
LOD-122-CNC
 Reception Desk Shell
 71" x 30" / 36" x 42"
 CU: 8.3 WT: 207.2
List Price: \$850



NAP-123
Glass Floating Top
 Fits NAP122
 71" x 17.5" x 0.5"
 CU: 2.1 WT: 79.4
List Price: \$495

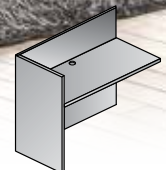

NAP-125-CHY
NAP-125-ESP
NAP-125-URB
LOD-125-CNC
 Reception Return Shell
 42" x 24" x 41"
 CU: 4.1 WT: 100.3
List Price: \$430

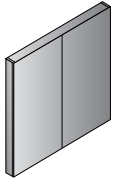

NAP-100-CHY
NAP-100-ESP
NAP-100-URB
 Presentation Board
 48" x 48"
 CU: 8.5 WT: 101.4
List Price: \$735
Ships Assembled

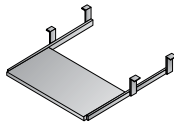

NAP-14-CHY
NAP-14-ESP
NAP-14-URB
LOD-14-BLK
 Keyboard Tray
 26" x 12"
 CU: 0.6 WT: 13.2
List Price: \$90

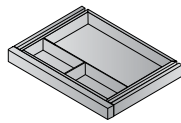

NAP-15-CHY
NAP-15-ESP
NAP-15-URB
LOD-15-BLK
 Center Drawer
 20" x 15"
 CU: 0.8 WT: 8.8
List Price: \$90

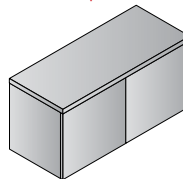

NAPWM36-CHY
NAPWM36-ESP
NAPWM36-URB
 Wall-Mount Overhead
 36" x 15" x 17"
 CU: 6.7 WT: 55
List Price: \$425
Ships Assembled

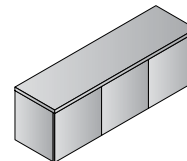

NAPWM48-CHY
NAPWM48-ESP
NAPWM48-URB
 Custom Fabric
 Tackboard
 48" x 15" x 17"
 CU: 8.8 WT: 70.4
List Price: \$535
Ships Assembled



NAPTB-3
 Tackboard for NAP42/44
 SON44, KEN42/44
 65" x 17.5"
 Black Fabric
 CU: 1.2 WT: 15
List Price: \$195
Tackboard
 Custom Fabric
 NAPTB_ ___
 (Specify Fabric)
Grade A \$250
Grade B \$280
Grade C \$310
Grade R \$340



LODURB-41: Overhead with Wood/Glass Doors

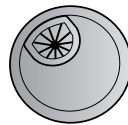

NAP-GM
 Metallic Grommets
 (5-Pack)
 2.5" x 2.5" x 1"
 CU: 0.02 WT: 0.05
List Price: \$95



NAP-PM
 Metallic Drawer Pulls
 (10-Pack)
 4" x 1" x 0.5"
 CU: 0.005 WT: 0.01
List Price: \$95



LK1-GC
 Lock Core with Keys
\$15 List
KC-GC Change Key
\$8 List
KM-GC Master Key
\$8 List



LODURB-42: Overhead with Aluminum/Glass Doors



LODURB-44: Overhead with Wood Doors

NOTE: NAPA items on this page feature matching wood grain laminates with Lodi products shown on previous page.

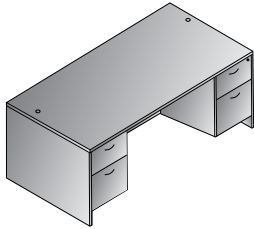

Double Pedestal Desk 71"x30"
LODxxx-TYP301
 10.8 cu. ft. 178.2 lbs.
 Consists of: LOD-101,76,76
\$1,130

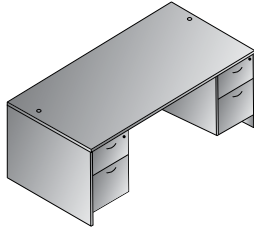

Double Pedestal Desk 71"x35"
LODxxx-TYP2
 11.2 cu. ft. 191.4 lbs.
 Consists of: LOD-01,76,76
\$1,155

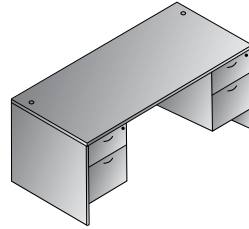

Double Pedestal Desk 66"x30"
LODxxx-TYP3
 10.3 cu. ft. 171.6 lbs.
 Consists of: LOD-02,76,76
\$1,085

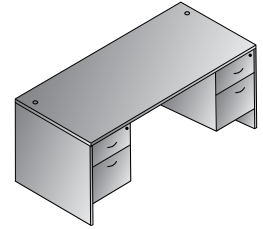

Double Pedestal Desk 60"x30"
LODxxx-TYP4
 10.0 cu. ft. 165 lbs.
 Consists of: LOD-03,76,76
\$1,055

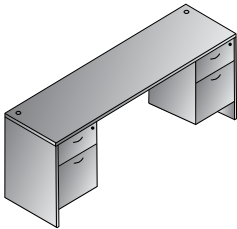

Double Pedestal Credenza 71"x20"
LODxxx-TYP5
 9.4 cu. ft. 147.4 lbs.
 Consists of: LOD-43,76,76
\$990

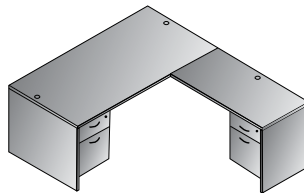

L-Shape Desk 71"x78"
LODxxx-TYP308
 12.4 cu. ft. 235.4 lbs.
 Consists of: LOD-101,76,45,76
\$1,430

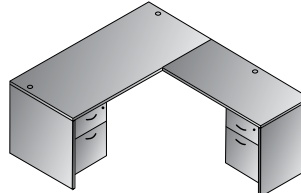

L-Shape 66"x78"
LODxxx-TYP9
 11.9 cu. ft. 228.8 lbs.
 Consists of: LOD-02,76,45,76
\$1,385

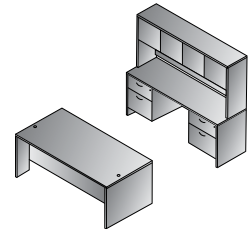

Executive Office
LODxxx-TYP311
 25.0 cu. ft. 444.6 lbs.
 Consists of: LOD-101,76,76,43, 76,76,44
 LOD44 consists of: LOD-44H,NAP-4DW
\$2,805

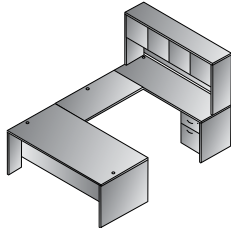

U Shape w/Hutch 71"x98"
LODxxx-TYP312
 19.6 cu. ft. 420.4 lbs.
 Consists of: LOD-101,76,70,43,76,44
 LOD44 consists of: LOD-44H,NAP-4DW
\$2,400

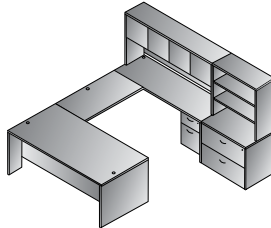

U Shape w/Hutch + Storage 101"x98"
LODxxx-TYP313
 32.8 cu. ft. 578.8 lbs.
 Consists of: LOD-101,76,70,43,76,44,12,53
 LOD44 consists of: LOD-44H,NAP-4DW
\$3,480

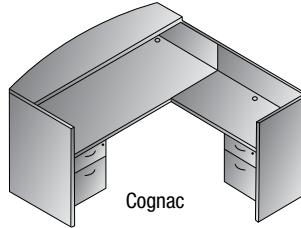

Reception Station 71"x78"x42"H
LODCNC-TYP19
 19.4 cu. ft. 377.9 lbs.
 Consists of: LOD-122,76,125,76
\$1,920
 For CHY, ESP & URB:
 Order Napa Components

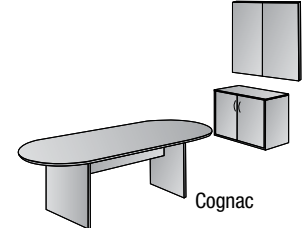

Conference Group 3-Pcs.
LODCNC-TYP20
 22.6 cu. ft. 371.3 lbs.
 Consists of: LOD-36,13,100
\$2,185
 For CHY, ESP & URB:
 Order Napa Components

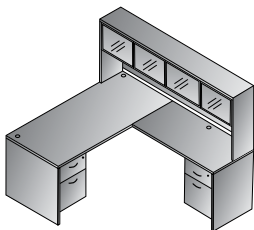

L-Shape w/Hutch 66"x72"
LODxxx-TYP31
 16.5 cu. ft. 338.8 lbs.
 Consists of: LOD-02,76,46,76,41
 LOD41 consists of: LOD-44H,NAP-4DC
\$2,070

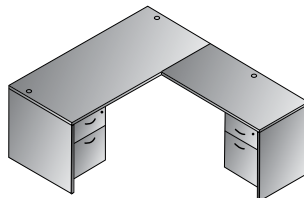

L-Shape 66"x72"
LODxxx-TYP32
 11.8 cu. ft. 217.8 lbs.
 Consists of: LOD-02,76,46,76
\$1,335

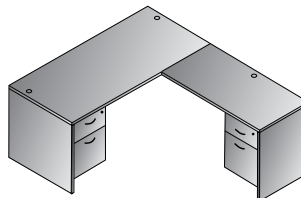

L-Shape 60"x72"
LODxxx-TYP34
 11.5 cu. ft. 211.2 lbs.
 Consists of: LOD-03,76,46,76
\$1,305

Finish Key
CHY - Cherry
CNC - Cognac
ESP - Espresso
URB - Urban Walnut

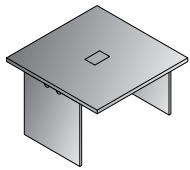

EXP-228-xxx
48"x48"
Table Component
47.2"x47.2"x29.1"
CU:5 WT:123.5
List Price: **\$750**

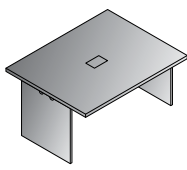

EXP-229-xxx
60"x48"
Table Component
59.1"x47.2"x29.1"
CU:5.3 WT:143.3
List Price: **\$850**

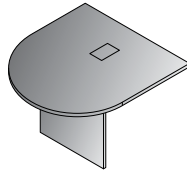

EXP-230-xxx
48"x48" Bullet Top
Component
47.2"x47.2"x29.1"
CU:4.3 WT:92.6
List Price: **\$700**

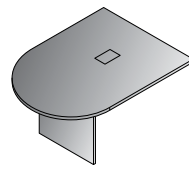

EXP-231-xxx
60"x48" Bullet Top
Component
59.1"x47.2"x29.1"
CU:6.6 WT:110.2
List Price: **\$800**

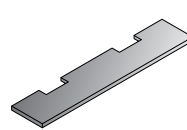

EXP-232-xxx
Stretcher for NAP230
2 qty.
55.1"x11.4"x1"
CU:0.7 WT:19.8
List Price: **\$145**

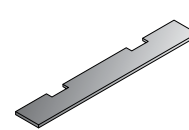

EXP-233-xxx
Stretcher for NAP231
2 qty.
78.7"x11.4"x1"
CU:0.9 WT:26.5
List Price: **\$180**

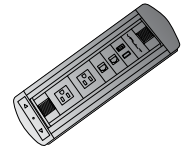

EXP-POW1
Power/Data/
HDMI Unit
5.25"x3"x1.25"
CU:0.4 WT:5.0
List Price: **\$950**



EXPCHY-TYP12R
Racetrack Table with 529-3R2N1F2 chairs

EXP-POW1
Power Data/HDMI Unit

Configuration Guide



30' Racetrack Table
EXPxxx-TYP30R

\$5,000
34.5 cu.ft. 793.7 lbs.
Consists of:
(4) qty. EXP-229
(2) qty. EXP-231



28' Racetrack Table
EXPxxx-TYP28R

\$4,800
33.8 cu.ft. 754.0 lbs.
Consists of:
(2) qty. EXP-228
(2) qty. EXP-229
(2) qty. EXP-231

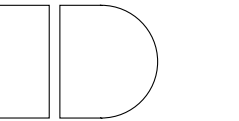

26' Racetrack Table
EXPxxx-TYP26R

\$4,600
33.1 cu.ft. 714.3 lbs.
Consists of:
(4) qty. EXP-228
(2) qty. EXP-231

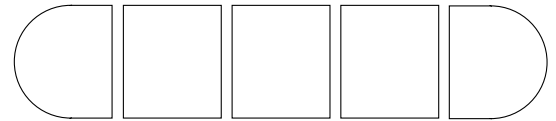

24' Racetrack Table
EXPxxx-TYP24R

\$4,050
28.8 cu.ft. 630.5 lbs.
Consists of:
(1) qty. EXP-228
(2) qty. EXP-229
(2) qty. EXP-231

22' Racetrack Table
EXPxxx-TYP22R

\$3,850
28.1 cu.ft. 590.8 lbs.
Consists of:
(3) qty. EXP-228
(2) qty. EXP-231



20' Racetrack Table
EXPxxx-TYP20R

\$3,300
23.9 cu.ft. 507.1 lbs.
Consists of:
(2) qty. EXP-229
(2) qty. EXP-231



18' Racetrack Table
EXPxxx-TYP18R

\$3,100
19.2 cu.ft. 471.8 lbs.
Consists of:
(2) qty. EXP-229
(2) qty. EXP-230



16' Racetrack Table
EXPxxx-TYP16R

\$2,900
18.2 cu.ft. 343.9 lbs.
Consists of:
(2) qty. EXP-228
(2) qty. EXP-230

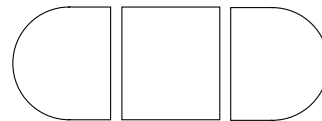

14' Racetrack Table
EXPxxx-TYP14R

\$2,350
18.2 cu.ft. 343.9 lbs.
Consists of:
(1) qty. EXP-228
(2) qty. EXP-231



12' Racetrack Table
EXPxxx-TYP12R

\$2,150
13.5 cu.ft. 308.6 lbs.
Consists of:
(1) qty. EXP-228
(2) qty. EXP-230

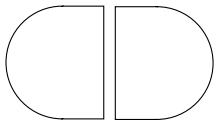

10' Racetrack Table
EXPxxx-TYP10R

\$1,780
14.2 cu.ft. 246.9 lbs.
Consists of:
(2) qty. EXP-231
(1) qty. EXP-233

8' Racetrack Table
EXPxxx-TYP8R

\$1,545
9.3 cu.ft. 205.0 lbs.
Consists of:
(2) qty. EXP-230
(1) qty. EXP-232

Finish Key

CHY - Cherry
ESP - Espresso



EXPESP-TYP12R

Racetrack Table with 13-V88N1WA chairs



LWS362448-URB

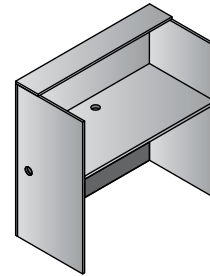

LWS362448-xxx
Laminate Workstation
36"x24"x48"
CU: 4.6 WT: 99.2
List Price: \$585

Available in:
ESP Espresso,
URB Urban Walnut

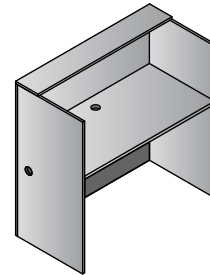

LWS482448-xxx
Laminate Workstation
48"x24"x48"
CU: 5.8 WT: 116.6
List Price: \$615

Available in:
CHY Cherry,
ESP Espresso,
URB Urban Walnut



LWS482448-ESP

Finish Key



CHY - Cherry



ESP - Espresso



URB - Urban Walnut

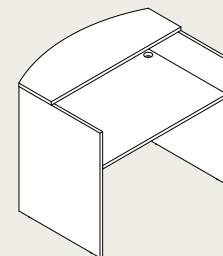

new
NAP-121-xxx
48" Reception Desk Shell
48"x32"x42"
CU: 6.4 WT: 164
List Price: \$745

Available in:
ESP Espresso
SGW Slate Grey

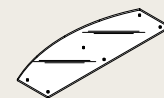

NAP-126
48"W Glass Top
*Fits NAP121ESP
48"x17.5"x48"
CU: 1.4 WT: 44
List Price: \$430

LBC361230-xxx 2-Shelf Laminate Bookcase with 1” Thick Shelves



	Finish	List
Overall Max: 36W x 12D x 30H 1 Adjustable Shelf, 1 Bottom Shelf Carton Wt: 60 lbs. Cube: 2.375 Carton: 38L x 36W x 3H UPS: No	Cherry (CHY)	\$295
	Espresso (ESP)	
	Mahogany (MAH)	
	Slate Grey (SGW) <small>new</small>	
	Cognac(CNC)	
	Urban Walnut (URB)	
	Maple (MPL)	

LBC361248-xxx 3-Shelf Laminate Bookcase with 1” Thick Shelves



	Finish	List
Overall Max: 36W x 12D x 48H 2 Adjustable Shelves, 1 Bottom Shelf Carton Wt: 88 lbs. Cube: 3.29 Carton: 50L x 38W x 3H UPS: No	Cherry (CHY)	\$395
	Espresso (ESP)	
	Mahogany (MAH)	
	Slate Grey (SGW) <small>new</small>	
	Cognac(CNC)	
	Urban Walnut (URB)	
	Maple (MPL)	

LBC361260-xxx 4-Shelf Laminate Bookcase with 1” Thick Shelves



	Finish	List
Overall Max: 36W x 12D x 60H 2 Adjustable Shelves, 1 Fixed, 1 Bottom Shelf Carton Wt: 108 lbs. Cube: 4.024 Carton: 61L x 38W x 3H UPS: No	Cherry (CHY)	\$490
	Espresso (ESP)	
	Mahogany (MAH)	
	Slate Grey (SGW) <small>new</small>	
	Cognac(CNC)	
	Urban Walnut (URB)	
	Maple (MPL)	

LBC361272-xxx 5-Shelf Laminate Bookcase with 1” Thick Shelves



	Finish	List
Overall Max: 36W x 12D x 72H 3 Adjustable Shelves, 1 Fixed, 1 Bottom Shelf Carton Wt: 130 lbs. Cube: 4.816 Carton: 73L x 38W x 3H UPS: No	Cherry (CHY)	\$575
	Espresso (ESP)	
	Mahogany (MAH)	
	Slate Grey (SGW) <small>new</small>	
	Cognac(CNC)	
	Urban Walnut (URB)	
	Maple (MPL)	

LBC361284-xxx 6-Shelf Laminate Bookcase with 1” Thick Shelves



	Finish	List
Overall Max: 36W x 12D x 84H 4 Adjustable Shelves, 1 Fixed, 1 Bottom Shelf Carton Wt: 151 lbs. Cube: 5.6 Carton: 85L x 38W x 3H UPS: No	Cherry (CHY)	\$645
	Espresso (ESP)	
	Mahogany (MAH)	
	Slate Grey (SGW) <small>new</small>	
	Cognac(CNC)	
	Urban Walnut (URB)	
	Maple (MPL)	

LBCSHF-xxx Extra 1” Thick Shelf for 36Wx12D Laminate Bookcases



	Finish	List
Overall Max: 36W x 12D x 1H Carton Wt: 10 lbs. Cube: 0.486 Carton: 35L x 12W x 2H UPS: Yes	Cherry (CHY)	\$48
	Espresso (ESP)	
	Mahogany (MAH)	
	Slate Grey (SGW) <small>new</small>	
	Cognac(CNC)	
	Urban Walnut (URB)	
	Maple (MPL)	



CHY - Cherry
In Stock: NJ & CA

ESP - Espresso
In Stock: NJ & CA

MAH - Mahogany
In Stock: NJ & CA

URB - Urban Walnut
In Stock: NJ & CA

SGW - Slate Grey
In Stock: NJ & CA

CNC - Cognac
In Stock: NJ

MPL - Maple
In Stock: NJ



Ascend II features top quality electric height adjustable workstations, coordinating with OSP systems, casegoods and table offering. Standard features include push-button height adjustment, 3-position programmable memory handset and anti-collision with sensitivity adjustment. Width-adjustable bases accommodate 48"-72" wide x 24" deep tops. Optional 30" deep feet. Simple assembly. Meets UL962 and ANSI/BIFMA.

TOP COLORS



Base (without top)	Height Range	Load Capacity	High/Low Position
A2EB322	25.5"	250 lb.	50" / 24.5"
A2EB333	25.5"	325 lb.	50" / 24.5"
A2EB222	17.3"	220 lb.	44.5" / 27.2"



Urban Walnut (U)



Slate Grey (S)



Espresso (E)

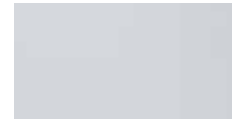

Grey (G)



Cherry (C)

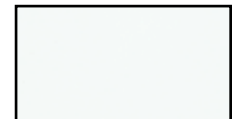

White (W)



Mahogany (M)



Maple (P)

Tops

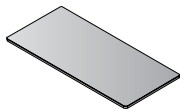

842T26-X
Table Top 72"x24"
CU: 1.9 WT: 44
List: **\$410**

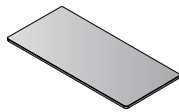

842T25-x
Table Top 60"x24"
CU: 1.6 WT: 36
List: **\$360**

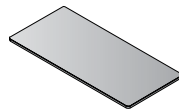

842T24-x
Table Top 48"x24"
CU: 1.3 WT: 28
List: **\$310**



842T3060-x
Table Top 60"x30"
CU: 2.5 WT: 50.7
List: **\$425**

Bases

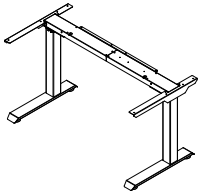

A2EB322-xx
3-Stage/2-Leg
CU: 3.0 WT: 77
List: **\$1,475**

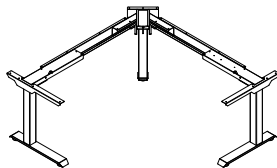

A2EB333-xx
3-Stage/3-Leg
CU: 3.3 WT: 110
List: **\$2,375**

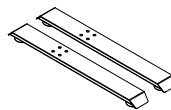

A2FEET30-x
Feet for 30"D Tops
(set of 2)
CU: 0.25 WT: 11.0
List: **\$165**

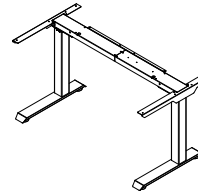

A2EB222-x
2-Stage/2-Leg
CU: 3.0 WT: 77
List: **\$1,375**

BASE COLORS



White (WH)

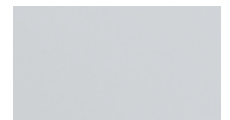

Silver (SV)

Bases are TAA Compliant

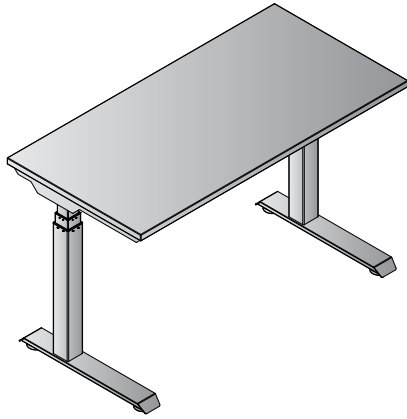

3-Stage 48" x 24"
 Electric Height Adjustable Table
 CU: 4.3 (2 cartons) WT.: 105
List: \$1,785

Typical#	List	Description	TOP	List	BASE	List
A322448SVC	\$1785	Cherry Top/Silver Base	842T24-C	\$310	A2EB322-SV	\$1475
A322448SVE	\$1785	Espresso Top/Silver Base	842T24-E	\$310	A2EB322-SV	\$1475
A322448SVG	\$1785	Grey Top/Silver Base	842T24-G	\$310	A2EB322-SV	\$1475
A322448SVM	\$1785	Mahogany Top/Silver Base	842T24-M	\$310	A2EB322-SV	\$1475
A322448SVP	\$1785	Maple Top/Silver Base	842T24-P	\$310	A2EB322-SV	\$1475
A322448SVS	\$1785	Slate Grey Top/Silver Base	842T24-S	\$310	A2EB322-SV	\$1475
A322448SVU	\$1785	Urban Walnut Top/Silver Base	842T24-U	\$310	A2EB322-SV	\$1475
A322448SW	\$1785	White Top/Silver Base	842T24-W	\$310	A2EB322-SV	\$1475
A322448WHC	\$1785	Cherry Top/White Base	842T24-C	\$310	A2EB322-WH	\$1475
A322448WHE	\$1785	Espresso Top/White Base	842T24-E	\$310	A2EB322-WH	\$1475
A322448WHG	\$1785	Grey Top/White Base	842T24-G	\$310	A2EB322-WH	\$1475
A322448WHM	\$1785	Mahogany Top/White Base	842T24-M	\$310	A2EB322-WH	\$1475
A322448WHP	\$1785	Maple Top/White Base	842T24-P	\$310	A2EB322-WH	\$1475
A322448WHS	\$1785	Slate Grey Top/White Base	842T24-S	\$310	A2EB322-WH	\$1475
A322448WHU	\$1785	Urban Walnut Top/White Base	842T24-U	\$310	A2EB322-WH	\$1475
A322448WHW	\$1785	White Top/White Base	842T24-W	\$310	A2EB322-WH	\$1475

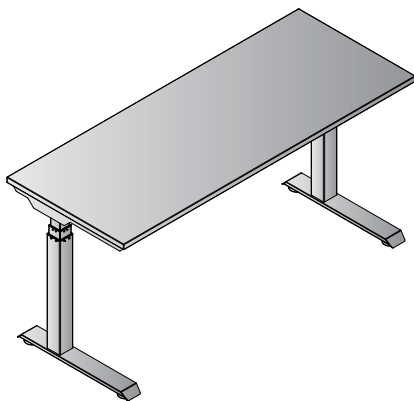

3-Stage 60" x 24"
 Electric Height Adjustable Table
 CU: 4.6 (2 cartons) WT.: 113
List: \$1,835

Typical#	List	Description	TOP	List	BASE	List
A322460SVC	\$1835	Cherry Top/Silver Base	842T25-C	\$360	A2EB322-SV	\$1475
A322460SVE	\$1835	Espresso Top/Silver Base	842T25-E	\$360	A2EB322-SV	\$1475
A322460SVG	\$1835	Grey Top/Silver Base	842T25-G	\$360	A2EB322-SV	\$1475
A322460SVM	\$1835	Mahogany Top/Silver Base	842T25-M	\$360	A2EB322-SV	\$1475
A322460SVP	\$1835	Maple Top/Silver Base	842T25-P	\$360	A2EB322-SV	\$1475
A322460SVS	\$1835	Slate Grey Top/Silver Base	842T25-S	\$360	A2EB322-SV	\$1475
A322460SVU	\$1835	Urban Walnut Top/Silver Base	842T25-U	\$360	A2EB322-SV	\$1475
A322460SW	\$1835	White Top/Silver Base	842T25-W	\$360	A2EB322-SV	\$1475
A322460WHC	\$1835	Cherry Top/White Base	842T25-C	\$360	A2EB322-WH	\$1475
A322460WHE	\$1835	Espresso Top/White Base	842T25-E	\$360	A2EB322-WH	\$1475
A322460WHG	\$1835	Grey Top/White Base	842T25-G	\$360	A2EB322-WH	\$1475
A322460WHM	\$1835	Mahogany Top/White Base	842T25-M	\$360	A2EB322-WH	\$1475
A322460WHP	\$1835	Maple Top/White Base	842T25-P	\$360	A2EB322-WH	\$1475
A322460WHS	\$1835	Slate Grey Top/White Base	842T25-S	\$360	A2EB322-WH	\$1475
A322460WHU	\$1835	Urban Walnut Top/White Base	842T25-U	\$360	A2EB322-WH	\$1475
A322460WHW	\$1835	White Top/White Base	842T25-W	\$360	A2EB322-WH	\$1475

Bases are TAA Compliant

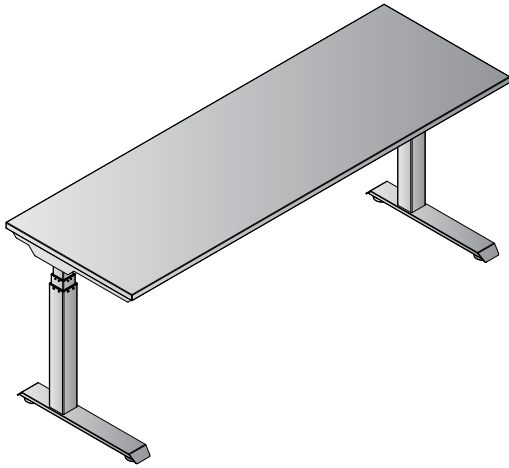

3-Stage 72" x 24"
Electric Height Adjustable Table
CU: 4.9 (2 cartons) WT.:121
List: \$1,885

Typical#	List	Description	TOP	List	BASE	List
A322472SVC	\$1885	Cherry Top/Silver Base	842T26-C	\$410	A2EB322-SV	\$1475
A322472SVE	\$1885	Espresso Top/Silver Base	842T26-E	\$410	A2EB322-SV	\$1475
A322472SVG	\$1885	Grey Top/Silver Base	842T26-G	\$410	A2EB322-SV	\$1475
A322472SVM	\$1885	Mahogany Top/Silver Base	842T26-M	\$410	A2EB322-SV	\$1475
A322472SVP	\$1885	Maple Top/Silver Base	842T26-P	\$410	A2EB322-SV	\$1475
A322472SVS	\$1885	Slate Grey Top/Silver Base	842T26-S	\$410	A2EB322-SV	\$1475
A322472SVU	\$1885	Urban Walnut Top/Silver Base	842T26-U	\$410	A2EB322-SV	\$1475
A322472SWW	\$1885	White Top/Silver Base	842T26-W	\$410	A2EB322-SV	\$1475
A322472WHC	\$1885	Cherry Top/White Base	842T26-C	\$410	A2EB322-WH	\$1475
A322472WHE	\$1885	Espresso Top/White Base	842T26-E	\$410	A2EB322-WH	\$1475
A322472WHG	\$1885	Grey Top/White Base	842T26-G	\$410	A2EB322-WH	\$1475
A322472WHM	\$1885	Mahogany Top/White Base	842T26-M	\$410	A2EB322-WH	\$1475
A322472WHP	\$1885	Maple Top/White Base	842T26-P	\$410	A2EB322-WH	\$1475
A322472WHS	\$1885	Slate Grey Top/White Base	842T26-S	\$410	A2EB322-WH	\$1475
A322472WHU	\$1885	Urban Walnut Top/White Base	842T26-U	\$410	A2EB322-WH	\$1475
A322472WHW	\$1885	White Top/White Base	842T26-W	\$410	A2EB322-WH	\$1475

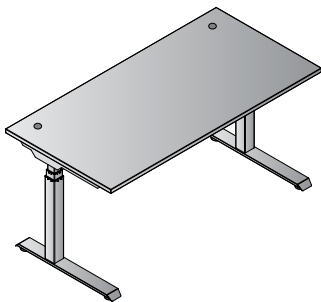

3-Stage 60" x 30"
Electric Height Adjustable Table
CU: 5.8 (3 cartons) WT.: 138.7
List: \$2,065

Typical#	List	Description	TOP	List	BASE	List	BASE	List
A323060SVC	\$2065	Cherry Top/Silver Base	842T3060-C	\$425	A2EB322-SV	\$1475	A2FEET30-SV	\$165
A323060SVE	\$2065	Espresso Top/Silver Base	842T3060-E	\$425	A2EB322-SV	\$1475	A2FEET30-SV	\$165
A323060SVG	\$2065	Grey Top/Silver Base	842T3060-G	\$425	A2EB322-SV	\$1475	A2FEET30-SV	\$165
A323060SVM	\$2065	Mahogany Top/Silver Base	842T3060-M	\$425	A2EB322-SV	\$1475	A2FEET30-SV	\$165
A323060SVP	\$2065	Maple Top/Silver Base	842T3060-P	\$425	A2EB322-SV	\$1475	A2FEET30-SV	\$165
A323060SVS	\$2065	Slate Grey Top/Silver Base	842T3060-S	\$425	A2EB322-SV	\$1475	A2FEET30-SV	\$165
A323060SVU	\$2065	Urban Walnut Top/Silver Base	842T3060-U	\$425	A2EB322-SV	\$1475	A2FEET30-SV	\$165
A323060SWW	\$2065	White Top/Silver Base	842T3060-W	\$425	A2EB322-SV	\$1475	A2FEET30-SV	\$165
A323060WHC	\$2065	Cherry Top/White Base	842T3060-C	\$425	A2EB322-WH	\$1475	A2FEET30-WH	\$165
A323060WHE	\$2065	Espresso Top/White Base	842T3060-E	\$425	A2EB322-WH	\$1475	A2FEET30-WH	\$165
A323060WHG	\$2065	Grey Top/White Base	842T3060-G	\$425	A2EB322-WH	\$1475	A2FEET30-WH	\$165
A323060WHM	\$2065	Mahogany Top/White Base	842T3060-M	\$425	A2EB322-WH	\$1475	A2FEET30-WH	\$165
A323060WHP	\$2065	Maple Top/White Base	842T3060-P	\$425	A2EB322-WH	\$1475	A2FEET30-WH	\$165
A323060WHS	\$2065	Slate Grey Top/White Base	842T3060-S	\$425	A2EB322-WH	\$1475	A2FEET30-WH	\$165
A323060WHU	\$2065	Urban Walnut Top/White Base	842T3060-U	\$425	A2EB322-WH	\$1475	A2FEET30-WH	\$165
A323060WHW	\$2065	White Top/White Base	842T3060-W	\$425	A2EB322-WH	\$1475	A2FEET30-WH	\$165

Bases are TAA Compliant

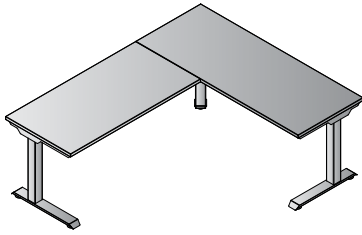

3-Stage 60'' x 72''
 Electric Height Adjustable L-Shape
 CU: 6.2 (3 cartons) WT.:174
List: \$3,045

Typical#	List	Description	TOP	List	TOP	List	BASE	List
A336072SVC	\$3045	Cherry Top/Silver Base	842T25-C	\$360	842T24-C	\$310	A2EB333-SV	\$2375
A336072SVE	\$3045	Espresso Top/Silver Base	842T25-E	\$360	842T24-E	\$310	A2EB333-SV	\$2375
A336072SVG	\$3045	Grey Top/Silver Base	842T25-G	\$360	842T24-G	\$310	A2EB333-SV	\$2375
A336072SVM	\$3045	Mahogany Top/Silver Base	842T25-M	\$360	842T24-M	\$310	A2EB333-SV	\$2375
A336072SVP	\$3045	Maple Top/Silver Base	842T25-P	\$360	842T24-P	\$310	A2EB333-SV	\$2375
A336072SVS	\$3045	Slate Grey Top/Silver Base	842T25-S	\$360	842T24-S	\$310	A2EB333-SV	\$2375
A336072SVU	\$3045	Urban Walnut Top/Silver Base	842T25-U	\$360	842T24-U	\$310	A2EB333-SV	\$2375
A336072SWW	\$3045	White Top/Silver Base	842T25-W	\$360	842T24-W	\$310	A2EB333-SV	\$2375
A336072WHC	\$3045	Cherry Top/White Base	842T25-C	\$360	842T24-C	\$310	A2EB333-WH	\$2375
A336072WHE	\$3045	Espresso Top/White Base	842T25-E	\$360	842T24-E	\$310	A2EB333-WH	\$2375
A336072WHG	\$3045	Grey Top/White Base	842T25-G	\$360	842T24-G	\$310	A2EB333-WH	\$2375
A336072WHM	\$3045	Mahogany Top/White Base	842T25-M	\$360	842T24-M	\$310	A2EB333-WH	\$2375
A336072WHP	\$3045	Maple Top/White Base	842T25-P	\$360	842T24-P	\$310	A2EB333-WH	\$2375
A336072WHS	\$3045	Slate Grey Top/White Base	842T25-S	\$360	842T24-S	\$310	A2EB333-WH	\$2375
A336072WHU	\$3045	Urban Walnut Top/White Base	842T25-U	\$360	842T24-U	\$310	A2EB333-WH	\$2375
A336072WHW	\$3045	White Top/White Base	842T25-W	\$360	842T24-W	\$310	A2EB333-WH	\$2375

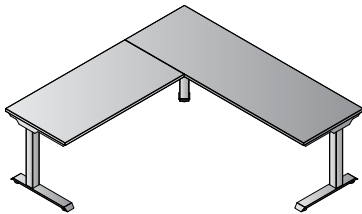

3-Stage 72'' x 72''
 Electric Height Adjustable L-Shape
 CU: 6.5 (3 cartons) WT.:182
List: \$3,095

Typical#	List	Description	TOP	List	TOP	List	BASE	List
A337272SVC	\$3095	Cherry Top/Silver Base	842T26-C	\$410	842T24-C	\$310	A2EB333-SV	\$2375
A337272SVE	\$3095	Espresso Top/Silver Base	842T26-E	\$410	842T24-E	\$310	A2EB333-SV	\$2375
A337272SVG	\$3095	Grey Top/Silver Base	842T26-G	\$410	842T24-G	\$310	A2EB333-SV	\$2375
A337272SVM	\$3095	Mahogany Top/Silver Base	842T26-M	\$410	842T24-M	\$310	A2EB333-SV	\$2375
A337272SVP	\$3095	Maple Top/Silver Base	842T26-P	\$410	842T24-P	\$310	A2EB333-SV	\$2375
A337272SVS	\$3095	Slate Grey Top/Silver Base	842T26-S	\$410	842T24-S	\$310	A2EB333-SV	\$2375
A337272SVU	\$3095	Urban Walnut Top/Silver Base	842T26-U	\$410	842T24-U	\$310	A2EB333-SV	\$2375
A337272SWW	\$3095	White Top/Silver Base	842T26-W	\$410	842T24-W	\$310	A2EB333-SV	\$2375
A337272WHC	\$3095	Cherry Top/White Base	842T26-C	\$410	842T24-C	\$310	A2EB333-WH	\$2375
A337272WHE	\$3095	Espresso Top/White Base	842T26-E	\$410	842T24-E	\$310	A2EB333-WH	\$2375
A337272WHG	\$3095	Grey Top/White Base	842T26-G	\$410	842T24-G	\$310	A2EB333-WH	\$2375
A337272WHM	\$3095	Mahogany Top/White Base	842T26-M	\$410	842T24-M	\$310	A2EB333-WH	\$2375
A337272WHP	\$3095	Maple Top/White Base	842T26-P	\$410	842T24-P	\$310	A2EB333-WH	\$2375
A337272WHS	\$3095	Slate Grey Top/White Base	842T26-S	\$410	842T24-S	\$310	A2EB333-WH	\$2375
A337272WHU	\$3095	Urban Walnut Top/White Base	842T26-U	\$410	842T24-U	\$310	A2EB333-WH	\$2375
A337272WHW	\$3095	White Top/White Base	842T26-W	\$410	842T24-W	\$310	A2EB333-WH	\$2375

⚙ Bases are TAA Compliant

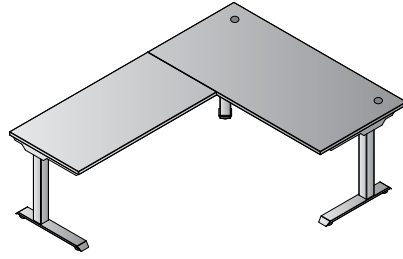

3-Stage 60'' x 78''

Electric Height Adjustable

L-Shape

CU: 7.4 (4 cartons) WT.:199.7

List: **\$3,275**

Typical#	List	Description	TOP	List	TOP	List	BASE	List	BASE	List
A336078SVC	\$3275	Cherry Top/Silver Base	842T3060-C	\$425	842T24-C	\$310	A2EB333-SV	\$2375	A2FEET30-SV	\$165
A336078SVE	\$3275	Espresso Top/Silver Base	842T3060-E	\$425	842T24-E	\$310	A2EB333-SV	\$2375	A2FEET30-SV	\$165
A336078SVG	\$3275	Grey Top/Silver Base	842T3060-G	\$425	842T24-G	\$310	A2EB333-SV	\$2375	A2FEET30-SV	\$165
A336078SVM	\$3275	Mahogany Top/Silver Base	842T3060-M	\$425	842T24-M	\$310	A2EB333-SV	\$2375	A2FEET30-SV	\$165
A336078SVP	\$3275	Maple Top/Silver Base	842T3060-P	\$425	842T24-P	\$310	A2EB333-SV	\$2375	A2FEET30-SV	\$165
A336078SVS	\$3275	Slate Grey Top/Silver Base	842T3060-S	\$425	842T24-S	\$310	A2EB333-SV	\$2375	A2FEET30-SV	\$165
A336078SVU	\$3275	Urban Walnut Top/Silver Base	842T3060-U	\$425	842T24-U	\$310	A2EB333-SV	\$2375	A2FEET30-SV	\$165
A336078SWW	\$3275	White Top/Silver Base	842T3060-W	\$425	842T24-W	\$310	A2EB333-SV	\$2375	A2FEET30-SV	\$165
A336078WHC	\$3275	Cherry Top/White Base	842T3060-C	\$425	842T24-C	\$310	A2EB333-WH	\$2375	A2FEET30-WH	\$165
A336078WHE	\$3275	Espresso Top/White Base	842T3060-E	\$425	842T24-E	\$310	A2EB333-WH	\$2375	A2FEET30-WH	\$165
A336078WHG	\$3275	Grey Top/White Base	842T3060-G	\$425	842T24-G	\$310	A2EB333-WH	\$2375	A2FEET30-WH	\$165
A336078WHM	\$3275	Mahogany Top/White Base	842T3060-M	\$425	842T24-M	\$310	A2EB333-WH	\$2375	A2FEET30-WH	\$165
A336078WHP	\$3275	Maple Top/White Base	842T3060-P	\$425	842T24-P	\$310	A2EB333-WH	\$2375	A2FEET30-WH	\$165
A336078WHS	\$3275	Slate Grey Top/White Base	842T3060-S	\$425	842T24-S	\$310	A2EB333-WH	\$2375	A2FEET30-WH	\$165
A336078WHU	\$3275	Urban Walnut Top/White Base	842T3060-U	\$425	842T24-U	\$310	A2EB333-WH	\$2375	A2FEET30-WH	\$165
A336078WHW	\$3275	White Top/White Base	842T3060-W	\$425	842T24-W	\$310	A2EB333-WH	\$2375	A2FEET30-WH	\$165

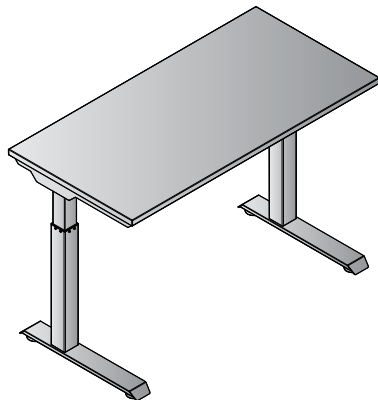

2-Stage 48'' x 24''

Electric Height Adjustable Table

CU: 4.3 (2 cartons) WT.:105

List: **\$1,685**

Typical#	List	Description	TOP	List	BASE	List
A222448SVC	\$1685	Cherry Top/Silver Base	842T24-C	\$310	A2EB222-SV	\$1375
A222448SVE	\$1685	Espresso Top/Silver Base	842T24-E	\$310	A2EB222-SV	\$1375
A222448SVG	\$1685	Grey Top/Silver Base	842T24-G	\$310	A2EB222-SV	\$1375
A222448SVM	\$1685	Mahogany Top/Silver Base	842T24-M	\$310	A2EB222-SV	\$1375
A222448SVP	\$1685	Maple Top/Silver Base	842T24-P	\$310	A2EB222-SV	\$1375
A222448SVS	\$1685	Slate Grey Top/Silver Base	842T24-S	\$310	A2EB222-SV	\$1375
A222448SVU	\$1685	Urban Walnut Top/Silver Base	842T24-U	\$310	A2EB222-SV	\$1375
A222448SWW	\$1685	White Top/Silver Base	842T24-W	\$310	A2EB222-SV	\$1375
A222448WHC	\$1685	Cherry Top/White Base	842T24-C	\$310	A2EB222-WH	\$1375
A222448WHE	\$1685	Espresso Top/White Base	842T24-E	\$310	A2EB222-WH	\$1375
A222448WHG	\$1685	Grey Top/White Base	842T24-G	\$310	A2EB222-WH	\$1375
A222448WHM	\$1685	Mahogany Top/White Base	842T24-M	\$310	A2EB222-WH	\$1375
A222448WHP	\$1685	Maple Top/White Base	842T24-P	\$310	A2EB222-WH	\$1375
A222448WHS	\$1685	Slate Grey Top/White Base	842T24-S	\$310	A2EB222-WH	\$1375
A222448WHU	\$1685	Urban Walnut Top/White Base	842T24-U	\$310	A2EB222-WH	\$1375
A222448WHW	\$1685	White Top/White Base	842T24-W	\$310	A2EB222-WH	\$1375

Ascend II - Electric Height Adjustable Tables

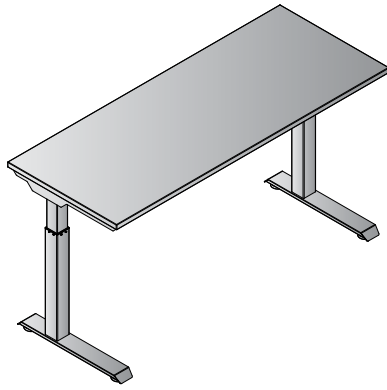

2-Stage 60" x 24"
Electric Height Adjustable Table
CU: 4.6 (2 cartons) WT.:113
List: \$1,735

Typical#	List	Description	TOP	List	BASE	List
A222460SVC	\$1735	Cherry Top/Silver Base	842T25-C	\$360	A2EB222-SV	\$1375
A222460SVE	\$1735	Espresso Top/Silver Base	842T25-E	\$360	A2EB222-SV	\$1375
A222460SVG	\$1735	Grey Top/Silver Base	842T25-G	\$360	A2EB222-SV	\$1375
A222460SVM	\$1735	Mahogany Top/Silver Base	842T25-M	\$360	A2EB222-SV	\$1375
A222460SVP	\$1735	Maple Top/Silver Base	842T25-P	\$360	A2EB222-SV	\$1375
A222460SVS	\$1735	Slate Grey Top/Silver Base	842T25-S	\$360	A2EB222-SV	\$1375
A222460SVU	\$1735	Urban Walnut Top/Silver Base	842T25-U	\$360	A2EB222-SV	\$1375
A222460SWW	\$1735	White Top/Silver Base	842T25-W	\$360	A2EB222-SV	\$1375
A222460WHC	\$1735	Cherry Top/White Base	842T25-C	\$360	A2EB222-WH	\$1375
A222460WHE	\$1735	Espresso Top/White Base	842T25-E	\$360	A2EB222-WH	\$1375
A222460WHG	\$1735	Grey Top/White Base	842T25-G	\$360	A2EB222-WH	\$1375
A222460WHM	\$1735	Mahogany Top/White Base	842T25-M	\$360	A2EB222-WH	\$1375
A222460WHP	\$1735	Maple Top/White Base	842T25-P	\$360	A2EB222-WH	\$1375
A222460WHS	\$1735	Slate Grey Top/White Base	842T25-S	\$360	A2EB222-WH	\$1375
A222460WHU	\$1735	Urban Walnut Top/White Base	842T25-U	\$360	A2EB222-WH	\$1375
A222460WHW	\$1735	White Top/White Base	842T25-W	\$360	A2EB222-WH	\$1375

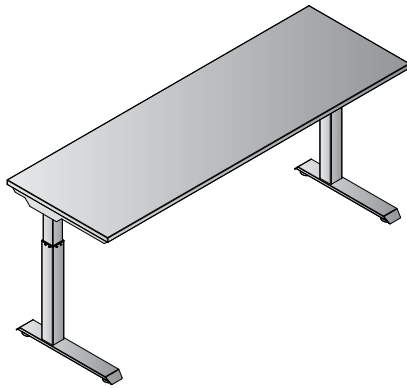

2-Stage 72" x 24"
Electric Height Adjustable Table
CU: 4.9 (2 cartons) WT.:121
List: \$1,785

Typical#	List	Description	TOP	List	BASE	List
A222472SVC	\$1785	Cherry Top/Silver Base	842T26-C	\$410	A2EB222-SV	\$1375
A222472SVE	\$1785	Espresso Top/Silver Base	842T26-E	\$410	A2EB222-SV	\$1375
A222472SVG	\$1785	Grey Top/Silver Base	842T26-G	\$410	A2EB222-SV	\$1375
A222472SVM	\$1785	Mahogany Top/Silver Base	842T26-M	\$410	A2EB222-SV	\$1375
A222472SVP	\$1785	Maple Top/Silver Base	842T26-P	\$410	A2EB222-SV	\$1375
A222472SVS	\$1785	Slate Grey Top/Silver Base	842T26-S	\$410	A2EB222-SV	\$1375
A222472SVU	\$1785	Urban Walnut Top/Silver Base	842T26-U	\$410	A2EB222-SV	\$1375
A222472SWW	\$1785	White Top/Silver Base	842T26-W	\$410	A2EB222-SV	\$1375
A222472WHC	\$1785	Cherry Top/White Base	842T26-C	\$410	A2EB222-WH	\$1375
A222472WHE	\$1785	Espresso Top/White Base	842T26-E	\$410	A2EB222-WH	\$1375
A222472WHG	\$1785	Grey Top/White Base	842T26-G	\$410	A2EB222-WH	\$1375
A222472WHM	\$1785	Mahogany Top/White Base	842T26-M	\$410	A2EB222-WH	\$1375
A222472WHP	\$1785	Maple Top/White Base	842T26-P	\$410	A2EB222-WH	\$1375
A222472WHS	\$1785	Slate Grey Top/White Base	842T26-S	\$410	A2EB222-WH	\$1375
A222472WHU	\$1785	Urban Walnut Top/White Base	842T26-U	\$410	A2EB222-WH	\$1375
A222472WHW	\$1785	White Top/White Base	842T26-W	\$410	A2EB222-WH	\$1375

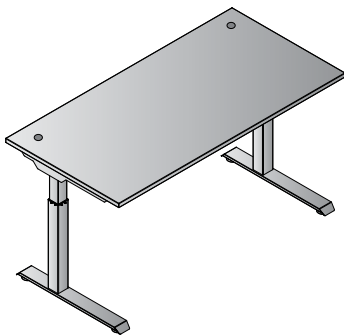

2-Stage 60" x 30"
Electric Height Adjustable Table
CU: 5.8 (3 cartons)
WT.:138.7
List: \$1,965

Typical#	List	Description	TOP	List	BASE	List	BASE	List
A223060SVC	\$1965	Cherry Top/Silver Base	842T3060-C	\$425	A2EB222-SV	\$1375	A2FEET30-SV	\$165
A223060SVE	\$1965	Espresso Top/Silver Base	842T3060-E	\$425	A2EB222-SV	\$1375	A2FEET30-SV	\$165
A223060SVG	\$1965	Grey Top/Silver Base	842T3060-G	\$425	A2EB222-SV	\$1375	A2FEET30-SV	\$165
A223060SVM	\$1965	Mahogany Top/Silver Base	842T3060-M	\$425	A2EB222-SV	\$1375	A2FEET30-SV	\$165
A223060SVP	\$1965	Maple Top/Silver Base	842T3060-P	\$425	A2EB222-SV	\$1375	A2FEET30-SV	\$165
A223060SVS	\$1965	Slate Grey Top/Silver Base	842T3060-S	\$425	A2EB222-SV	\$1375	A2FEET30-SV	\$165
A223060SVU	\$1965	Urban Walnut Top/Silver Base	842T3060-U	\$425	A2EB222-SV	\$1375	A2FEET30-SV	\$165
A223060SWW	\$1965	White Top/Silver Base	842T3060-W	\$425	A2EB222-SV	\$1375	A2FEET30-SV	\$165
A223060WHC	\$1965	Cherry Top/White Base	842T3060-C	\$425	A2EB222-WH	\$1375	A2FEET30-WH	\$165
A223060WHE	\$1965	Espresso Top/White Base	842T3060-E	\$425	A2EB222-WH	\$1375	A2FEET30-WH	\$165
A223060WHG	\$1965	Grey Top/White Base	842T3060-G	\$425	A2EB222-WH	\$1375	A2FEET30-WH	\$165
A223060WHM	\$1965	Mahogany Top/White Base	842T3060-M	\$425	A2EB222-WH	\$1375	A2FEET30-WH	\$165
A223060WHP	\$1965	Maple Top/White Base	842T3060-P	\$425	A2EB222-WH	\$1375	A2FEET30-WH	\$165
A223060WHS	\$1965	Slate Grey Top/White Base	842T3060-S	\$425	A2EB222-WH	\$1375	A2FEET30-WH	\$165
A223060WHU	\$1965	Urban Walnut Top/White Base	842T3060-U	\$425	A2EB222-WH	\$1375	A2FEET30-WH	\$165
A223060WHW	\$1965	White Top/White Base	842T3060-W	\$425	A2EB222-WH	\$1375	A2FEET30-WH	\$165

⚙️ Bases are TAA Compliant



shown: HB6025-3 Base with 842T25-C



Urban Walnut (U)



Slate Grey (S)



Cherry (C)



Espresso (E)

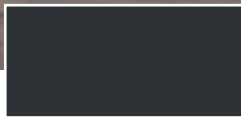

Black (3)

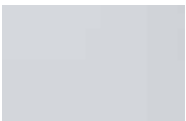

Grey (G)



Mahogany (M)



Titanium (7)



Maple (P)



White (W)



White (1)

TOP COLORS

BASE COLORS

⚙️ Bases are TAA Compliant



PHAT Pneumatic Height Adjustable Tables

Sit & stand throughout your workday to keep your body and mind in motion. New **PHAT Table** (Pneumatic Height Adjustable Tables) worksurfaces adjust from 30.25" to 43.25", a 13" range, with a single lever. Included black locking casters provide more on-the-go capability. Heavyweight bases include dual-pneumatic power and driveshaft-synchronized operation. Fully enclosed center channel conceals components. Tops and Bases sold, packed and shipped individually.

PHAT Tables: Pneumatic Height Adjustable Tables



White Top/White Base

48" x 24" Pneumatic Height Adjustable Table with Black Locking Casters

CU: 3.1 (2 cartons) WT.: 95

List: \$1,210

⚙️ Bases are TAA Compliant

Typical#	Description	TOP	List	BASE	List
PHAT2448C1	Cherry Top/White Base	842T24-C	\$310	HB6024-1	\$900
PHAT2448E1	Espresso Top/White Base	842T24-E	\$310	HB6024-1	\$900
PHAT2448G1	Grey Top/White Base	842T24-G	\$310	HB6024-1	\$900
PHAT2448M1	Mahogany Top/White Base	842T24-M	\$310	HB6024-1	\$900
PHAT2448P1	Maple Top/White Base	842T24-P	\$310	HB6024-1	\$900
PHAT2448S1	Slate Grey Top/White Base	842T24-S	\$310	HB6024-1	\$900
PHAT2448U1	Urban Walnut Top/White Base	842T24-U	\$310	HB6024-1	\$900
PHAT2448W1	White Top/White Base	842T24-W	\$310	HB6024-1	\$900
PHAT2448C3	Cherry Top/Black Base	842T24-C	\$310	HB6024-3	\$900
PHAT2448E3	Espresso Top/Black Base	842T24-E	\$310	HB6024-3	\$900
PHAT2448G3	Grey Top/Black Base	842T24-G	\$310	HB6024-3	\$900
PHAT2448M3	Mahogany Top/Black Base	842T24-M	\$310	HB6024-3	\$900
PHAT2448P3	Maple Top/Black Base	842T24-P	\$310	HB6024-3	\$900
PHAT2448S3	Slate Grey Top/Black Base	842T24-S	\$310	HB6024-3	\$900
PHAT2448U3	Urban Walnut Top/Black Base	842T24-U	\$310	HB6024-3	\$900
PHAT2448W3	White Top/Black Base	842T24-W	\$310	HB6024-3	\$900
PHAT2448C7	Cherry Top/Titanium Base	842T24-C	\$310	HB6024-7	\$900
PHAT2448E7	Espresso Top/Titanium Base	842T24-E	\$310	HB6024-7	\$900
PHAT2448G7	Grey Top/Titanium Base	842T24-G	\$310	HB6024-7	\$900
PHAT2448M7	Mahogany Top/Titanium Base	842T24-M	\$310	HB6024-7	\$900
PHAT2448P7	Maple Top/Titanium Base	842T24-P	\$310	HB6024-7	\$900
PHAT2448S7	Slate Grey Top/Titanium Base	842T24-S	\$310	HB6024-7	\$900
PHAT2448U7	Urban Walnut Top/Titanium Base	842T24-U	\$310	HB6024-7	\$900
PHAT2448W7	White Top/Titanium Base	842T24-W	\$310	HB6024-7	\$900

CU: 1.3 WT: 30 CU: 1.8 WT: 65



Cherry Top/Titanium Base

60" x 24" Pneumatic Height Adjustable Table with Black Locking Casters

CU: 3.8 (2 cartons) WT.: 107

List: \$1,310

⚙️ Bases are TAA Compliant

PHAT2460C1	Cherry Top/White Base	842T25-C	\$360	HB6025-1	\$950
PHAT2460E1	Espresso Top/White Base	842T25-E	\$360	HB6025-1	\$950
PHAT2460G1	Grey Top/White Base	842T25-G	\$360	HB6025-1	\$950
PHAT2460M1	Mahogany Top/White Base	842T25-M	\$360	HB6025-1	\$950
PHAT2460P1	Maple Top/White Base	842T25-P	\$360	HB6025-1	\$950
PHAT2460S1	Slate Grey Top/White Base	842T25-S	\$360	HB6025-1	\$950
PHAT2460U1	Urban Walnut Top/White Base	842T25-U	\$360	HB6025-1	\$950
PHAT2460W1	White Top/White Base	842T25-W	\$360	HB6025-1	\$950
PHAT2460C3	Cherry Top/Black Base	842T25-C	\$360	HB6025-3	\$950
PHAT2460E3	Espresso Top/Black Base	842T25-E	\$360	HB6025-3	\$950
PHAT2460G3	Grey Top/Black Base	842T25-G	\$360	HB6025-3	\$950
PHAT2460M3	Mahogany Top/Black Base	842T25-M	\$360	HB6025-3	\$950
PHAT2460P3	Maple Top/Black Base	842T25-P	\$360	HB6025-3	\$950
PHAT2460S3	Slate Grey Top/Black Base	842T25-S	\$360	HB6025-3	\$950
PHAT2460U3	Urban Walnut Top/Black Base	842T25-U	\$360	HB6025-3	\$950
PHAT2460W3	White Top/Black Base	842T25-W	\$360	HB6025-3	\$950
PHAT2460C7	Cherry Top/Titanium Base	842T25-C	\$360	HB6025-7	\$950
PHAT2460E7	Espresso Top/Titanium Base	842T25-E	\$360	HB6025-7	\$950
PHAT2460G7	Grey Top/Titanium Base	842T25-G	\$360	HB6025-7	\$950
PHAT2460M7	Mahogany Top/Titanium Base	842T25-M	\$360	HB6025-7	\$950
PHAT2460P7	Maple Top/Titanium Base	842T25-P	\$360	HB6025-7	\$950
PHAT2460S7	Slate Grey Top/Titanium Base	842T25-S	\$360	HB6025-7	\$950
PHAT2460U7	Urban Walnut Top/Titanium Base	842T25-U	\$360	HB6025-7	\$950
PHAT2460W7	White Top/Titanium Base	842T25-W	\$360	HB6025-7	\$950

CU: 1.6 WT: 37 CU: 2.2 WT: 107

Casegoods IN STOCK



Maple Top/Black Base

Typical#	Description	TOP	List	BASE	List
PHAT2472C1	\$1410 Cherry Top/White Base	842T26-C	\$410	HB6026-1	\$1000
PHAT2472E1	\$1410 Espresso Top/White Base	842T26-E	\$410	HB6026-1	\$1000
PHAT2472G1	\$1410 Grey Top/White Base	842T26-G	\$410	HB6026-1	\$1000
PHAT2472M1	\$1410 Mahogany Top/White Base	842T26-M	\$410	HB6026-1	\$1000
PHAT2472P1	\$1410 Maple Top/White Base	842T26-P	\$410	HB6026-1	\$1000
PHAT2472S1	\$1410 Slate Grey Top/White Base	842T26-S	\$410	HB6026-1	\$1000
PHAT2472U1	\$1410 Urban Walnut Top/White Base	842T26-U	\$410	HB6026-1	\$1000
PHAT2472W1	\$1410 White Top/White Base	842T26-W	\$410	HB6026-1	\$1000
PHAT2472C3	\$1410 Cherry Top/Black Base	842T26-C	\$410	HB6026-3	\$1000
PHAT2472E3	\$1410 Espresso Top/Black Base	842T26-E	\$410	HB6026-3	\$1000
PHAT2472G3	\$1410 Grey Top/Black Base	842T26-G	\$410	HB6026-3	\$1000
PHAT2472M3	\$1410 Mahogany Top/Black Base	842T26-M	\$410	HB6026-3	\$1000
PHAT2472P3	\$1410 Maple Top/Black Base	842T26-P	\$410	HB6026-3	\$1000
PHAT2472S3	\$1410 Slate Grey Top/Black Base	842T26-S	\$410	HB6026-3	\$1000
PHAT2472U3	\$1410 Urban Walnut Top/Black Base	842T26-U	\$410	HB6026-3	\$1000
PHAT2472W3	\$1410 White Top/Black Base	842T26-W	\$410	HB6026-3	\$1000
PHAT2472C7	\$1410 Cherry Top/Titanium Base	842T26-C	\$410	HB6026-7	\$1000
PHAT2472E7	\$1410 Espresso Top/Titanium Base	842T26-E	\$410	HB6026-7	\$1000
PHAT2472G7	\$1410 Grey Top/Titanium Base	842T26-G	\$410	HB6026-7	\$1000
PHAT2472M7	\$1410 Mahogany Top/Titanium Base	842T26-M	\$410	HB6026-7	\$1000
PHAT2472P7	\$1410 Maple Top/Titanium Base	842T26-P	\$410	HB6026-7	\$1000
PHAT2472S7	\$1410 Slate Grey Top/Titanium Base	842T26-S	\$410	HB6026-7	\$1000
PHAT2472U7	\$1410 Urban Walnut Top/Titanium Base	842T26-U	\$410	HB6026-7	\$1000
PHAT2472W7	\$1410 White Top/Titanium Base	842T26-W	\$410	HB6026-7	\$1000

72" x 24" Pneumatic Height Adjustable Table with Black Locking Casters
 CU: 4.6 (2 cartons) WT.: 118
List: \$1,410

⚙️ Bases are TAA Compliant

CU: 1.9 WT: 44 CU: 2.7 WT: 74



White Top/White Base

Grey Top/Titanium Base

Cherry Top/Titanium Base

Maple Top/Black Base



HB4GLIDE
 Floor Glides (set of 4)
 Carton Wt: 1 Cube: 0.195
 Designed For: PHAT & HAT Tables
List Price: \$25 (set of 4)



Transform your work surface into a healthier, more productive sit/stand desk

- 16.5" Adjustment Range
- Dual-Pneumatic Lift
- Tension Adjustment
- Dual Handles
- Locks in 8 Positions
- Supports 33 lbs.
- Fits 24" D Work Surfaces, Including Returns, Bridges and Credenzas
- Integrated Tablet Holder and Cord Management
- Keyboard Surface 28.25" W x 10" D
- Work Surface 36" W x 22" D

Multiposition Desk Riser DR3622-xxx
 36.25"W x 26.5"D x 6.75" - 16.5"H
\$950
 6.78 cu.ft. 53 lbs.
 Carton: 41L x 26W x 11H



White (-WH)



Black (-BK)

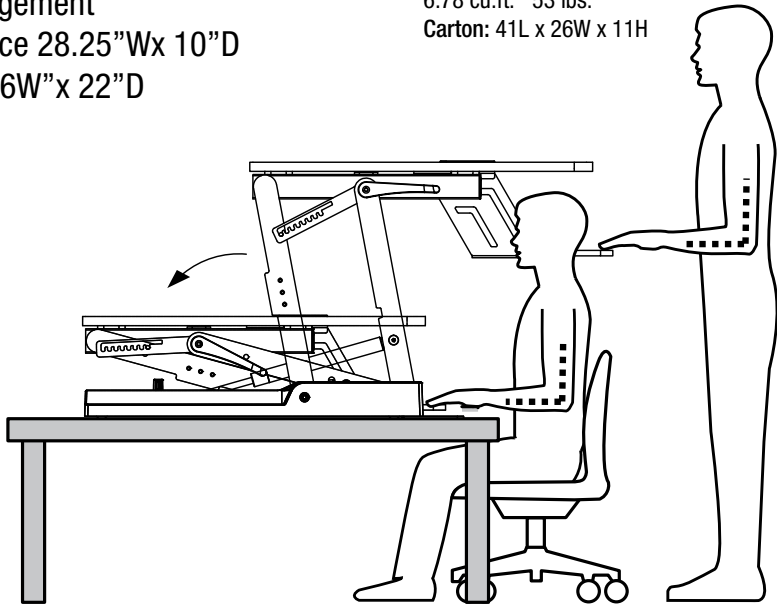



Cherry (CHY)



Mahogany (MAH)



Espresso (ESP)

NAPA MULTI-POSITION DESK RISER

- 16.75" adjustment range
- 10 position height adjustment
- Dual handles
- Spring-assist lift
- Supports up to 33 lbs.
- No assembly required
- Available in Cherry (CHY), Mahogany (MAH), Espresso (ESP) and Urban Walnut (URB)
- Patent No. US 9,681,746
- Worksurface: 35"W x 20"D
- Keyboard Platform: 26"W x 13"D

NAP3529-xxx
 35.5W x 29D x 16.75H
\$775



Urban Walnut (URB)

Folding/Nesting Training Tables

24 Color Combinations



Nesting Chairs
shown on pages 125 and 169.

84224BP Table
EM51022N Chair



TOP COLORS

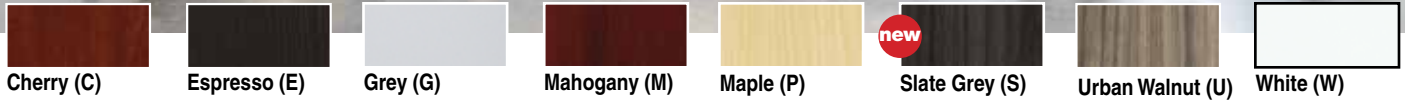

BASE COLORS



Folding. Nesting. Mobile.

Flip-Top Training Tables allow quick setup and change of table configurations to address any event. Easily convert from training to classroom to conference room configuration. Tables also fold/nest for space savings when not in use.



One-touch flip mechanism can be activated from either end of the table. Top locks into position when upright or horizontal.

All-steel frames feature modesty panel and full-length top support. Each includes (4) oversize locking casters designed for use on all floors.

Tops are 1" thick laminate with smooth, impact-resistant PVC edges. Underside includes metal inserts for included ganging clips.

Comprehensive selection of folding/nesting chairs available.

Ganging Feature



Easy-to-reach, easy-to-secure Ganging Clips are included with each base. Thin-profile design is barely visible when installed. Located near table edges/corners for ease of use.

Tops

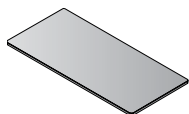

842T26-x
Table Top
72"x24"
CU:1.9 WT:44
List Price: **\$410**

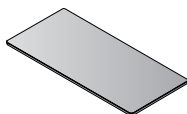

842T25-x
Table Top
60"x24"
CU:1.6 WT:36
List Price: **\$360**

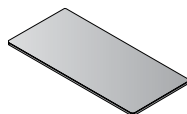

842T24-x
Table Top
48"x24"
CU:1.3 WT:28
List Price: **\$310**

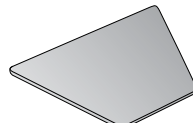

842TPZ24-x
Trapezoid Table Top
46.5"x20.5" w/24" Connecting Sides
CU:1.2 WT:22.0
List Price: **\$295**
**Not available in W, E, S or U*

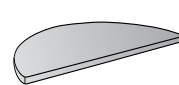

842THR24-x
Half-Round Table Top
48"x24"
CU:1.2 WT:26.2
List Price: **\$295**
**Not available in W, E, S or U*

Bases

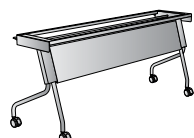

842FM6-x
6' Frame
CU:4.5 WT:51
List Price: **\$500**



842FM5-x
5' Frame
CU:3.7 WT:46
List Price: **\$460**



842FM4-x
4' Frame
CU:2.9 WT:41
List Price: **\$420**



842FMPZHR4-x
Frame for Trapezoid and Half-Round Tops
CU:2.4 WT:35.3
List Price: **\$375**
**Not available in White*



842GK1
Extra Ganging Kit
Brackets (2)
Thumb screws (4)
List Price: **\$10**

Folding/Nesting Training Tables



72" x 24" x 29.5" Tables

CU: 6.4 WT.: 95



Maple Top/Black Base



White Top/Titanium Base



new

Urban Walnut Top / White Base

Typical	List	Description	TOP	List	BASE	List
84226BC	\$910	Cherry Top / Black Base	842T26-C	\$410	842FM6-B	\$500
84226BE	\$910	Espresso Top / Black Base	842T26-E	\$410	842FM6-B	\$500
84226BG	\$910	Grey Top / Black Base	842T26-G	\$410	842FM6-B	\$500
84226BM	\$910	Mahogany Top / Black Base	842T26-M	\$410	842FM6-B	\$500
84226BP	\$910	Maple Top / Black Base	842T26-P	\$410	842FM6-B	\$500
84226BS	\$910	Slate Grey Top / Black Base	842T26-S	\$410	842FM6-B	\$500
84226BU	\$910	Urban Walnut Top / Black Base	842T26-U	\$410	842FM6-B	\$500
84226BW	\$910	White Top / Black Base	842T26-W	\$410	842FM6-B	\$500
84226TC	\$910	Cherry Top / Titanium Base	842T26-C	\$410	842FM6-T	\$500
84226TE	\$910	Espresso Top / Titanium Base	842T26-E	\$410	842FM6-T	\$500
84226TG	\$910	Grey Top / Titanium Base	842T26-G	\$410	842FM6-T	\$500
84226TM	\$910	Mahogany Top / Titanium Base	842T26-M	\$410	842FM6-T	\$500
84226TP	\$910	Maple Top / Titanium Base	842T26-P	\$410	842FM6-T	\$500
84226TS	\$910	Slate Grey Top / Titanium Base	842T26-S	\$410	842FM6-T	\$500
84226TU	\$910	Urban Walnut Top / Titanium Base	842T26-U	\$410	842FM6-T	\$500
84226TW	\$910	White Top / Titanium Base	842T26-W	\$410	842FM6-T	\$500
84226WC	\$910	Cherry Top / White Base	842T26-C	\$410	842FM6-W	\$500
84226WE	\$910	Espresso Top / White Base	842T26-E	\$410	842FM6-W	\$500
84226WG	\$910	Grey Top / White Base	842T26-G	\$410	842FM6-W	\$500
84226WM	\$910	Mahogany Top / White Base	842T26-M	\$410	842FM6-W	\$500
84226WP	\$910	Maple Top / White Base	842T26-P	\$410	842FM6-W	\$500
84226WS	\$910	Slate Grey Top / White Base	842T26-S	\$410	842FM6-W	\$500
84226WU	\$910	Urban Walnut Top / White Base	842T26-U	\$410	842FM6-W	\$500
84226WW	\$910	White Top / White Base	842T26-W	\$410	842FM6-W	\$500

60" x 24" x 29.5" Tables

CU: 5.3 WT.: 82



Maple Top/Black Base



Cherry Top/Titanium Base

84225BC	\$820	Cherry Top / Black Base	842T25-C	\$360	842FM5-B	\$460
84225BE	\$820	Espresso Top / Black Base	842T25-E	\$360	842FM5-B	\$460
84225BG	\$820	Grey Top / Black Base	842T25-G	\$360	842FM5-B	\$460
84225BM	\$820	Mahogany Top / Black Base	842T25-M	\$360	842FM5-B	\$460
84225BP	\$820	Maple Top / Black Base	842T25-P	\$360	842FM5-B	\$460
84225BS	\$820	Slate Grey Top / Black Base	842T25-S	\$360	842FM5-B	\$460
84225BU	\$820	Urban Walnut Top / Black Base	842T25-U	\$360	842FM5-B	\$460
84225BW	\$820	White Top / Black Base	842T25-W	\$360	842FM5-B	\$460
84225TC	\$820	Cherry Top / Titanium Base	842T25-C	\$360	842FM5-T	\$460
84225TE	\$820	Espresso Top / Titanium Base	842T25-E	\$360	842FM5-T	\$460
84225TG	\$820	Grey Top / Titanium Base	842T25-G	\$360	842FM5-T	\$460
84225TM	\$820	Mahogany Top / Titanium Base	842T25-M	\$360	842FM5-T	\$460
84225TP	\$820	Maple Top / Titanium Base	842T25-P	\$360	842FM5-T	\$460
84225TS	\$820	Slate Grey Top / Titanium Base	842T25-S	\$360	842FM5-T	\$460
84225TU	\$820	Urban Walnut Top / Titanium Base	842T25-U	\$360	842FM5-T	\$460
84225TW	\$820	White Top / Titanium Base	842T25-W	\$360	842FM5-T	\$460
84225WC	\$820	Cherry Top / White Base	842T25-C	\$360	842FM5-W	\$460
84225WE	\$820	Espresso Top / White Base	842T25-E	\$360	842FM5-W	\$460
84225WG	\$820	Grey Top / White Base	842T25-G	\$360	842FM5-W	\$460
84225WM	\$820	Mahogany Top / White Base	842T25-M	\$360	842FM5-W	\$460
84225WP	\$820	Maple Top / White Base	842T25-P	\$360	842FM5-W	\$460
84225WS	\$820	Slate Grey Top / White Base	842T25-S	\$360	842FM5-W	\$460
84225WU	\$820	Urban Walnut Top / White Base	842T25-U	\$360	842FM5-W	\$460
84225WW	\$820	White Top / White Base	842T25-W	\$360	842FM5-W	\$460

⚙️ Bases are TAA Compliant

48" x 24" x 29.5" Tables

CU: 4.2 WT.: 69



Espresso Top/
Titanium Base



nesting in
White Top/
Titanium Base

Typical	List	Description	TOP	List	BASE	List
84224BC	\$730	Cherry Top / Black Base	842T24-C	\$310	842FM4-B	\$420
84224BE	\$730	Espresso Top / Black Base	842T24-E	\$310	842FM4-B	\$420
84224BG	\$730	Grey Top / Black Base	842T24-G	\$310	842FM4-B	\$420
84224BM	\$730	Mahogany Top / Black Base	842T24-M	\$310	842FM4-B	\$420
84224BP	\$730	Maple Top / Black Base	842T24-P	\$310	842FM4-B	\$420
84224BS	\$730	Slate Grey Top / Black Base	842T24-S	\$310	842FM4-B	\$420
84224BU	\$730	Urban Walnut Top / Black Base	842T24-U	\$310	842FM4-B	\$420
84224BW	\$730	White Top / Black Base	842T24-W	\$310	842FM4-B	\$420
84224TC	\$730	Cherry Top / Titanium Base	842T24-C	\$310	842FM4-T	\$420
84224TE	\$730	Espresso Top / Titanium Base	842T24-E	\$310	842FM4-T	\$420
84224TG	\$730	Grey Top / Titanium Base	842T24-G	\$310	842FM4-T	\$420
84224TM	\$730	Mahogany Top / Titanium Base	842T24-M	\$310	842FM4-T	\$420
84224TP	\$730	Maple Top / Titanium Base	842T24-P	\$310	842FM4-T	\$420
84224TS	\$730	Slate Grey Top / Titanium Base	842T24-S	\$310	842FM4-T	\$420
84224TU	\$730	Urban Walnut Top / Titanium Base	842T24-U	\$310	842FM4-T	\$420
84224TW	\$730	White Top / Titanium Base	842T24-W	\$310	842FM4-T	\$420
84224WC	\$730	Cherry Top / White Base	842T24-C	\$310	842FM4-W	\$420
84224WE	\$730	Espresso Top / White Base	842T24-E	\$310	842FM4-W	\$420
84224WG	\$730	Grey Top / White Base	842T24-G	\$310	842FM4-W	\$420
84224WM	\$730	Mahogany Top / White Base	842T24-M	\$310	842FM4-W	\$420
84224WP	\$730	Maple Top / White Base	842T24-P	\$310	842FM4-W	\$420
84224WS	\$730	Slate Grey Top / White Base	842T24-S	\$310	842FM4-W	\$420
84224WU	\$730	Urban Walnut Top / White Base	842T24-U	\$310	842FM4-W	\$420
84224WW	\$730	White Top / White Base	842T24-W	\$310	842FM4-W	\$420

Trapezoid Tables

46.5" x 20.5" x 29.5"

CU: 3.6 WT.: 57.3



Grey Top/
Titanium Base

Typical	List	Description	TOP	List	BASE	List
842PZ24BC	\$670	Cherry Top / Black Base	842TPZ24-C	\$295	842FMPZHR4-B	\$375
842PZ24BG	\$670	Grey Top / Black Base	842TPZ24-G	\$295	842FMPZHR4-B	\$375
842PZ24BM	\$670	Mahogany Top / Black Base	842TPZ24-M	\$295	842FMPZHR4-B	\$375
842PZ24BP	\$670	Maple Top / Black Base	842TPZ24-P	\$295	842FMPZHR4-B	\$375
842PZ24TC	\$670	Cherry Top / Titanium Base	842TPZ24-C	\$295	842FMPZHR4-T	\$375
842PZ24TG	\$670	Grey Top / Titanium Base	842TPZ24-G	\$295	842FMPZHR4-T	\$375
842PZ24TM	\$670	Mahogany Top / Titanium Base	842TPZ24-M	\$295	842FMPZHR4-T	\$375
842PZ24TP	\$670	Maple Top / Titanium Base	842TPZ24-P	\$295	842FMPZHR4-T	\$375

Half-Round Tables

48" x 24" x 29.5"

CU: 3.6 WT.: 51.5



Grey Top/
Titanium Base

Typical	List	Description	TOP	List	BASE	List
842HR24BC	\$670	Cherry Top / Black Base	842THR24-C	\$295	842FMPZHR4-B	\$375
842HR24BG	\$670	Grey Top / Black Base	842THR24-G	\$295	842FMPZHR4-B	\$375
842HR24BM	\$670	Mahogany Top / Black Base	842THR24-M	\$295	842FMPZHR4-B	\$375
842HR24BP	\$670	Maple Top / Black Base	842THR24-P	\$295	842FMPZHR4-B	\$375
842HR24TC	\$670	Cherry Top / Titanium Base	842THR24-C	\$295	842FMPZHR4-T	\$375
842HR24TG	\$670	Grey Top / Titanium Base	842THR24-G	\$295	842FMPZHR4-T	\$375
842HR24TM	\$670	Mahogany Top / Titanium Base	842THR24-M	\$295	842FMPZHR4-T	\$375
842HR24TP	\$670	Maple Top / Titanium Base	842THR24-P	\$295	842FMPZHR4-T	\$375

⚙️ Bases are TAA Compliant



Multipurpose PACE modular components create training, class and computer room tables. Unique U-shaped conference tables also available. Tops are 1-1/8" thick laminate with 3mm PVC edges and available support bars. Choose T-arc or Post legs with levelers in Black or Metallic finish. Add-on casters available. Metal-to-metal fastening allows quick, easy assembly and reconfiguration. Laminate colors match Napa series casegoods.



Finish Key



MAH Mahogany Top



GRY Grey Top



MAH
Mahogany Modesty Panel



CHA
Charcoal Grey Modesty Panel

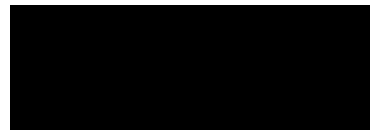

BLK Black Legs

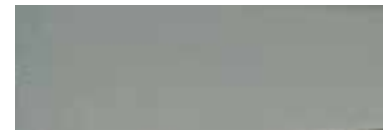

MET Metallic Legs

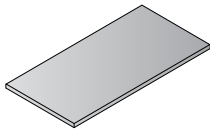

PAC-RCT4824-GRY
Rectangular Top
48"x 24"
CU: 1.5 WT: 35.3
List Price: **\$230**

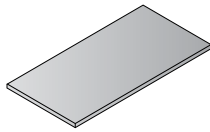

PAC-RCT4824-MAH
Rectangular Top
48"x 24"
CU: 1.5 WT: 35.3
List Price: **\$230**

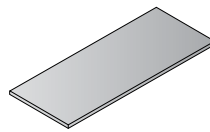

PAC-RCT6024-GRY
Rectangular Top
60"x 24"
CU: 1.8 WT: 41.9
List Price: **\$300**

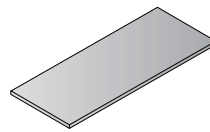

PAC-RCT6024-MAH
Rectangular Top
60"x 24"
CU: 1.8 WT: 41.9
List Price: **\$300**

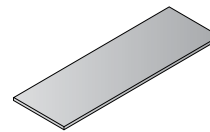

PAC-RCT7224-GRY
Rectangular Top
72"x 24"
CU: 2.2 WT: 50.7
List Price: **\$375**

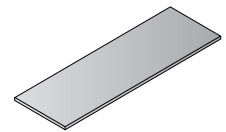

PAC-RCT7224-MAH
Rectangular Top
72"x 24"
CU: 2.2 WT: 50.7
List Price: **\$375**

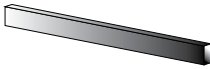

PAC-SB4
Support Bar
For 48" Top
CU: 0.05 WT: 0.75
List Price: **\$49**

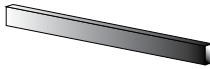

PAC-SB5
Support Bar
For 60" Top
CU: 0.06 WT: 1.25
List Price: **\$60**

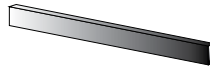

PAC-SB6
Support Bar
For 72" Top
CU: 0.07 WT: 1.50
List Price: **\$70**

Support Bars

- * Order with all PACE Rectangular Tops
- * Provides increased weight support and stability
- * Center on underside of Top; mount with supplied wood screws
- * Powder-coated steel construction
- * Black only



PAC-LEGTARC-MET
T-Arc Leg
CU: 1.9 WT: 13.2
List Price: **\$235**



PAC-LEGTARC-BLK
T-Arc Leg
CU: 1.9 WT: 13.2
List Price: **\$235**

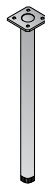

PAC-LEGPOST-MET
Post Leg
CU: 0.4 WT: 8.8
List Price: **\$90**
Includes adjustable leg leveler
Leg adjusts 28.5"H - 30"H



PAC-LEGPOST-BLK
Post Leg
CU: 0.4 WT: 8.8
List Price: **\$90**
Includes adjustable leg leveler
Leg adjusts 28.5"H - 30"H

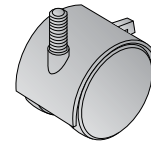

PAC-4CASTER
Set of 4 Casters
for Post Legs
CU: 0.01 WT: 2.2
List Price: **\$22**
Post Legs with Casters are 29.5"H

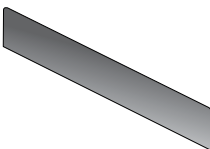

PAC-PS4
Privacy Screen
For 48" Top
CU: 0.2 WT: 10.0
List Price: **\$295**

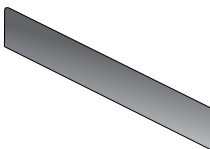

PAC-PS5
Privacy Screen
For 60" Top
CU: 0.3 WT: 12.5
List Price: **\$335**

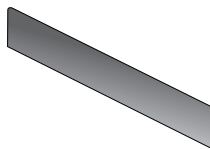

PAC-PS6
Privacy Screen
For 72" Top
CU: 0.4 WT: 15.0
List Price: **\$375**

Privacy Screens

- * Use with PAC-RCT rectangular tops
- * Adds visual privacy (14" H)
- * Tackable surface
- * Black fabric
- * Includes metallic mounting hardware

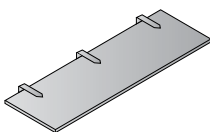

PAC-MOD48-CHA
Modesty Panel
for 48" Top
CU: 0.8 WT: 13.2
List Price: **\$160**

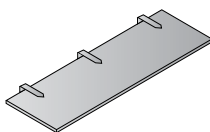

PAC-MOD48-MAH
Modesty Panel
for 48" Top
CU: 0.8 WT: 13.2
List Price: **\$160**

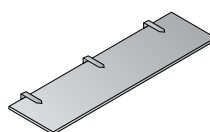

PAC-MOD60-CHA
Modesty Panel
for 60" Top
CU: 1.1 WT: 15.4
List Price: **\$190**

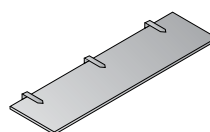

PAC-MOD60-MAH
Modesty Panel
for 60" Top
CU: 1.1 WT: 15.4
List Price: **\$190**

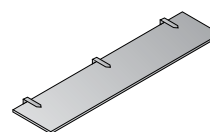

PAC-MOD72-CHA
Modesty Panel
for 72" Top
CU: 1.3 WT: 17.6
List Price: **\$215**

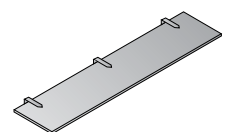

PAC-MOD72-MAH
Modesty Panel
for 72" Top
CU: 1.3 WT: 17.6
List Price: **\$215**

Note: Modesty Panels are optional.

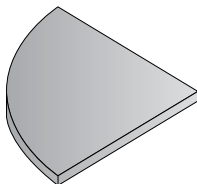

PAC-QRT2424-GRY
Quarter Round Top
24"x 24"
CU: 0.8 WT: 17.6
List Price: **\$160**

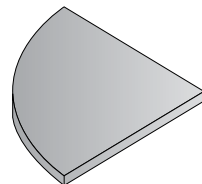

PAC-QRT2424-MAH
Quarter Round Top
24"x 24"
CU: 0.8 WT: 17.6
List Price: **\$160**

All items priced individually.



Top & T-Arc Legs



Top, Modesty Panel & T-Arc Legs



Top & Post Legs



Top, Modesty Panel & Post Legs

4' Table - 48" x 24"

PAC-TT48A ___ / ___
List Price \$700
 Cu. Ft: 5.3 Wt: 61.7
 Consists of:
 PAC-RCT4824 ___
 PAC-LEGTARC ___ (2 qty.)

PAC-TT48AM ___ / ___
List Price \$860
 Cu. Ft: 6.1 Wt: 74.9
 Consists of:
 PAC-RCT4824 ___
 PAC-MOD48 ___
 PAC-LEGTARC ___ (2 qty.)

PAC-TT48P ___ / ___
List Price \$590
 Cu. Ft: 3.1 Wt: 70.5
 Consists of:
 PAC-RCT4824 ___
 PAC-LEGPOST ___ (4 qty.)

PAC-TT48PM ___ / ___
List Price \$750
 Cu. Ft: 3.9 Wt: 83.7
 Consists of:
 PAC-RCT4824 ___
 PAC-MOD48 ___
 PAC-LEGPOST ___ (4 qty.)

5' Table - 60" x 24"

PAC-TT60A ___ / ___
List Price \$830
 Cu. Ft: 5.6 Wt: 69.5
 Consists of:
 PAC-RCT6024 ___
 PAC-LEGTARC ___ (2 qty.)
 PAC-SB5

PAC-TT60AM ___ / ___
List Price \$1,020
 Cu. Ft: 6.8 Wt: 85.0
 Consists of:
 PAC-RCT6024 ___
 PAC-MOD60 ___
 PAC-LEGTARC ___ (2 qty.)
 PAC-SB5

PAC-TT60P ___ / ___
List Price \$720
 Cu. Ft: 3.5 Wt: 78.4
 Consists of:
 PAC-RCT6024 ___
 PAC-LEGPOST ___ (4 qty.)
 PAC-SB5

PAC-TT60PM ___ / ___
List Price \$910
 Cu. Ft: 4.6 Wt: 93.8
 Consists of:
 PAC-RCT6024 ___
 PAC-MOD60 ___
 PAC-LEGPOST ___ (4 qty.)
 PAC-SB5

6' Table - 72" x 24"

PAC-TT72A ___ / ___
List Price \$915
 Cu. Ft: 6.0 Wt: 79.6
 Consists of:
 PAC-RCT7224 ___
 PAC-LEGTARC ___ (2 qty.)
 PAC-SB6

PAC-TT72AM ___ / ___
List Price \$1,130
 Cu. Ft: 7.4 Wt: 97.2
 Consists of:
 PAC-RCT7224 ___
 PAC-MOD72 ___
 PAC-LEGTARC ___ (2 qty.)
 PAC-SB6

PAC-TT72P ___ / ___
List Price \$805
 Cu. Ft: 3.9 Wt: 87.4
 Consists of:
 PAC-RCT7224 ___
 PAC-LEGPOST ___ (4 qty.)
 PAC-SB6

PAC-TT72PM ___ / ___
List Price \$1,020
 Cu. Ft: 5.2 Wt: 105
 Consists of:
 PAC-RCT7224 ___
 PAC-MOD72 ___
 PAC-LEGPOST ___ (4 qty.)
 PAC-SB6

Finish Key (Tops)



MAH - Mahogany GRY - Grey

Finish Key (Legs)



BLK - Black MET - Metallic Legs

Finish Key (Modesty Panels)



MAH - Mahogany CHA - Charcoal

Order Example

PAC-TT48AMAH/BLK

Top: MAH Mahogany

Legs: BLK Black

new

White & Silver 36" W Lateral Files



All OSP METAL units are built with heavy-gauge steel, MIG & TIG welding and powdercoat finishes for long-lasting quality and durability. Lateral files and pedestals are factory-assembled with premium features and limited lifetime warranty. Choose from multiple colors.



P Putty

G Light Grey

C Charcoal

B Black

Lateral Files 36" & 42" Wide

- 2, 3, 4 & 5-drawer all-metal files
- 6 color options
- Side-to-side Letter, Legal & A4 filing
- Full-extension, steel ball-bearing drawer slides
- Safety interlock allows only one drawer to open at a time
- Integrated full-width pull design for easy opening of drawers
- Random-keyed, core-removable locks with replacement cores in multiple numbers available for customized security
- Adjustable leg levelers
- Complies with ANSI/BIFMA standards covering 21 different testing sections
- Optional front-to-back filing rails (LF100)



WH White

SV Silver

Pedestals 22" D

- Closed Top pedestals (PTC) include counterweight and casters, two are locking
- Open Top pedestals include 1"-adjustable glides
- Front-to-back Letter & side-to-side Legal filing with full extension drawers
- Black metal drawers with high sides and ball-bearing suspensions
- Optional casters (PCASTER) and adjustable glides (PGLIDE)
- Complies with ANSI/BIFMA standards

All Metal Files, Pedestals and Storage Cabinets have achieved GREENGUARD Certification



LF236-x 36" Wide 2-Drawer Lateral File with Core-Removeable Lock & Adjustable Glides



	Finish	List
Overall Max: 36W x 20D x 28H	B Black	\$775
Drawer: 32.25W x 15.75D x 9.5H	C Charcoal	
Carton Wt: 133 lbs.	G Light Grey	
Cube: 14.66	P Putty	
Options: Front to Back Rails (LF 100)	SV Silver <small>new</small>	
Note: Drawer Weight Capacity: 64 lbs.	WH White <small>new</small>	
UPS: No	Ships Fully Assembled	

LF336-x 36" Wide 3-Drawer Lateral File with Core-Removeable Lock & Adjustable Glides



	Finish	List
Overall Max: 36W x 20D x 40H	B Black	\$1125
Drawer: 32.25W x 15.75D x 9.5H	C Charcoal	
Carton Wt: 168 lbs.	G Light Grey	
Cube: 19.83	P Putty	
Options: Front to Back Rails (LF 100)	SV Silver <small>new</small>	
Note: Drawer Weight Capacity: 64 lbs.	WH White <small>new</small>	
UPS: No	Ships Fully Assembled	

LF436-x 36" Wide 4-Drawer Lateral File with Core-Removeable Lock & Adjustable Glides



	Finish	List
Overall Max: 36W x 20D x 52H	B Black	\$1360
Drawer: 32.25W x 15.75D x 9.5H	C Charcoal	
Carton Wt: 191 lbs.	G Light Grey	
Cube: 25.64	P Putty	
Options: Front to Back Rails (LF 100)	SV Silver <small>new</small>	
Note: Drawer Weight Capacity: 64 lbs.	WH White <small>new</small>	
UPS: No	Ships Fully Assembled	

LF536-x 36" Wide 5-Drawer Lateral File with Core-Removeable Lock, Adjustable Glides & Top Drawer with Open Sides



	Finish	List
Overall Max: 36W x 20D x 64H	B Black	\$1865
Drawer: 32.25W x 15.75D x 9.5H	C Charcoal	
Carton Wt: 246 lbs.	G Light Grey	
Cube: 31.93	P Putty	
Options: Front to Back Rails (LF 100)	SV Silver <small>new</small>	
Note: Drawer Weight Capacity: 64 lbs.	WH White <small>new</small>	
UPS: No	Ships Fully Assembled	

LF242-x 42" Wide 2-Drawer Lateral File with Core-Removeable Lock & Adjustable Glides



	Finish	List
Overall Max: 42W x 20D x 28H	B Black	\$850
Drawer: 40.25W x 15.75D x 9.5H	C Charcoal	
Carton Wt: 152 lbs.	G Light Grey	
Cube: 16.24	P Putty	
Options: Front to Back Rails (LF 100)		
Note: Drawer Weight Capacity: 76 lbs.		
UPS: No	Ships Fully Assembled	

LF342-x 42" Wide 3-Drawer Lateral File with Core-Removeable Lock & Adjustable Glides



	Finish	List
Overall Max: 42W x 20D x 40H	B Black	\$1250
Drawer: 40.25W x 15.75D x 9.5H	C Charcoal	
Carton Wt: 180 lbs.	G Light Grey	
Cube: 22.96	P Putty	
Options: Front to Back Rails (LF 100)		
Note: Drawer Weight Capacity: 76 lbs.		
UPS: No	Ships Fully Assembled	

⚙️ All items are TAA Compliant

Metal IN STOCK

All Metal Files, Pedestals and Storage Cabinets have achieved GREENGUARD Certification



LF442-x 42" Wide 4-Drawer Lateral File with Core-Removeable Lock & Adjustable Glides



	Finish	List
Overall Max: 42W x 20D x 52H	B Black	\$1515
Drawer: 40.25W x 15.75D x 9.5H	C Charcoal	
Carton Wt: 220 lbs.	G Light Grey	
Cube: 29.68	P Putty	
Options: Front to Back Rails (LF 100)		
Note: Drawer Weight Capacity: 76 lbs.		
UPS: No		
	Ships Fully Assembled	

LF542-x 42" Wide 5-Drawer Lateral File with Core-Removeable Lock, Adjustable Glides & Top Drawer with Open Sides



	Finish	List
Overall Max: 42W x 20D x 64H	B Black	\$2065
Drawer: 40.25W x 15.75D x 9.5H	C Charcoal	
Carton Wt: 261 lbs.	G Light Grey	
Cube: 36.97	P Putty	
Options: Front to Back Rails (LF 100)		
Note: Drawer Weight Capacity: 76 lbs.		
UPS: No		
	Ships Fully Assembled	

PTC22FF-x 22" Closed Top Pedestal with Casters - File/File, Counter Weight Included



	Finish	List
Overall Max: 14.75W x 21.75D x 27.75H	B Black	\$430
Drawer: 18D	M Med Tone	
	G Light Grey	
Carton Wt: 57 lbs.	P Putty	
Cube: 6.33	SV Silver <small>new</small>	
Options: N/A	WH White <small>new</small>	
UPS: No		
	Requires Caster Attachment	

PTO22FF-x 22" Open Top Pedestal with Adjustable Glides - File/File



	Finish	List
Overall Max: 14.75W x 21.75D x 27.75H	B Black	\$415
Drawer: 18D	M Med Tone	
	G Light Grey	
Carton Wt: 57 lbs.	P Putty	
Cube: 6.33	SV Silver <small>new</small>	
Options: Casters for Open Top Pedestal (PCASTER)	WH White <small>new</small>	
UPS: No		
	Requires Leveler Attachment	

PTC22BBF-x 22" Closed Top Pedestal with Casters - Box/Box/File, Counter Weight Included



	Finish	List
Overall Max: 14.75W x 21.75D x 27.75H	B Black	\$430
Drawer: 18D	M Med Tone	
	G Light Grey	
Carton Wt: 64 lbs.	P Putty	
Cube: 6.33	SV Silver <small>new</small>	
Options: N/A	WH White <small>new</small>	
UPS: No		
	Requires Caster Attachment	

PTO22BBF-x 22" Open Top Pedestal with Adjustable Glides - Box/Box/File



	Finish	List
Overall Max: 14.75W x 21.75D x 27.75H	B Black	\$415
Drawer: 18D	M Med Tone	
	G Light Grey	
Carton Wt: 64 lbs.	P Putty	
Cube: 6.33	SV Silver <small>new</small>	
Options: Casters for Open Top Pedestal (PCASTER)	WH White <small>new</small>	
UPS: No		
	Requires Leveler Attachment	

All items are TAA Compliant



All Metal Files, Pedestals and Storage Cabinets have achieved GREENGUARD Certification

Metal IN STOCK

ST423618-x 42" High Storage Cabinet with 1 Adjustable Shelf



	Finish	List
Overall Max: 36W x 18D x 42H	B Black	\$500
	C Charcoal	
	G Light Grey	
	P Putty	
Carton Wt: 81 lbs.		
Cube: 3.7		
Options: Extra Shelves (STSHF18)		
UPS: No	Assembly Required	

ST723618-x 72" High Storage Cabinet with 4 Adjustable Shelves



	Finish	List
Overall Max: 36W x 18D x 72H	B Black	\$725
	C Charcoal	
	G Light Grey	
	P Putty	
Carton Wt: 137 lbs.		
Cube: 6.5		
Options: Extra Shelves (STSHF18)		
UPS: No	Assembly Required	

BXPMC22BF-GY Mobile File with Cushion



	Fabric	List
Overall Max: 15.6W x 21.8D x 21.9H	Icon Black	\$450
	Grade A	\$485
	Grade B	\$500
	Grade C	\$535
	Grade R	\$560
Carton: 16.33W x 24.25D x 21.85H		
Carton Wt: 44 lbs. UPS Wt: 45 lbs		
Cube: 5.2		
COM: 1 yard		
UPS: Yes	Ships Fully Assembled	

Option	Description	List Price
LF-LK1	Lock Core + 2 Keys	\$9
LF-LK2	Lock Housing, Core + 2 Keys - Lateral Files & Mobile (PTC) Pedestals	\$15
PED-LK2	Lock Housing, Core + 2 Keys Fixed (PTO) Pedestals & Metal Desks	\$15
LF-KM	Master Key	\$8
LF-KC	Change Key	\$8
LF-KB	Blank Key	\$8
LF100	Front to Back Rails (set of 2)	\$15
LF120	Drawer Sides Cover Rails (set of 2)	\$15
STSHF18	Extra Shelves (set of 2)	\$100
PCASTER	Casters for Pedestals (set of 4)	\$12
PGLIDE	Adjustable Glides for Pedestals (set of 4)	\$9
PED-BDD	Drawer Divider for Box Drawers	\$15
PCONV	Convert Open Top Pedestal to Mobile/Closed Top Pedestal (Specify Color)	\$100

Storage Units

- 270-degree opening doors
- 80 lb. shelf capacity
- Includes lock
- Optional additional shelves (STSHR-18)
- Requires assembly



All items are TAA Compliant

Metal IN STOCK

All Metal Files, Pedestals and Storage Cabinets have achieved GREENGUARD Certification



Kenwood

Wood Characteristics

- Select hardwood veneers book-matched
- Light cherry over cherry veneer
- Mahogany over hardwood veneer
- Coordinating veneer vertical surfaces

Design Details

- Fluted wood edges
- Common grain direction on tops of all components of L and U workstations
- Coordinating drawer interiors
- All-metal drawer pulls

Construction

- Kenwood features 1-1/8" tops; 1" end panels; 5/8" modesty panels

- All desk, return, bridge and credenza shells assemble with metal fasteners
- Pedestals ship assembled
- Additional pre-assembled units include KEN-10, 12, 52 & 100

Office

- Contour shapes include P-top and bullet desks; curved corner desks and credenzas; tables
- P-top desks, curved corner desks and credenzas are handed (left/right); plan accordingly
- Returns/bridges 36", 42" & 48" widths
- Lateral file and combo file pedestals
- Pedestals include single-key locking, five-sided drawer boxes, pre-installed filing hardware for legal/letter filing and full-extension, ball-bearing drawer slides
- Center drawer & keyboard tray

Conference

- Racetrack tables 6', 8', 10', 12' & 14' with 1-1/8" thick tops and half-cylinder bases
- 42" & 48" Round tables with full-cylinder base
- Complementing presentation board, conference credenza, etc.

Reception

- Reception desk and return feature 41" high end and modesty panels
- Reception desk includes bow front transaction counter
- Optional return transaction counter (KEN124)

Sonoma

Wood Characteristics

- Select hardwood veneers book-matched
- Solid hardwood edges
- Cherry finish with medium sheen

Design Details

- Radius wood edges on tops and modesty panels
- Compound radius corners on tops
- Common grain direction on tops of all components of L and U workstations
- Fingerpull design drawer fronts
- Coordinating wood drawer interiors

Construction

- Sonoma features 1-1/8" tops and end panels;

5/8" modesty panels

- All shells assemble with metal fasteners
- Pedestals ship assembled
- Additional pre-assembled units include SON-10, 12, 52, 100, 108 & 109

Office

- Contour shapes include P-top and bullet desks; curved corner desks and credenzas; tables
- P-top desks, curved corner desks and credenzas are handed (left/right); plan accordingly
- Returns/bridges 36", 42" and 48" widths
- Lateral file and combo file pedestals
- Pedestals include single-key locking, five-sided drawer boxes, pre-installed filing hardware for legal/letter filing and full-extension, ball-bearing

drawer slides

- 2, 3 and 4-drawer lateral files with pre-installed metal filing hardware and anti-tilt feature
- Center drawer & keyboard tray

Conference

- Racetrack tables 6', 8', 10', 12' & 14' with 2"-thick tops and half-cylinder bases
- 42" & 48" Round tables with full-cylinder base
- Complementing presentation board, conference credenza, etc.

Reception

- Reception desk and return feature 41" high end and modesty panels
- Reception desk includes bow front transaction counter
- Optional return transaction counter (SON124)

Townsend

Wood Characteristics

- American Walnut veneers on horizontal and vertical surfaces
- Parquet veneer design on worksurfaces
- Book-matched veneer on vertical surfaces

Finishes

- Royal Cherry with satin polyurethane finish

Design Details

- 3" thick tops with multi-step, shaped wood edges
- Solid hardwood picture-frame molding on pedestals and modesty panels
- Shaped veneer base trim on pedestals and modesty panels
- Decorative pilaster moldings on pedestals
- Double-rossette, antique brass drawer pulls

Construction

- 3" thick tops with multi-step, shaped wood edges
- All tops and pedestals are handed (left/right)

- Metal-to-metal connection of tops to pedestals
- Quick-connect mechanical fastener connection of modesty panels to pedestals
- Two-piece false pedestal; front integrated with modesty panel; end ships with full pedestal
- Desk pedestals box/box/file; ship assembled
- Return/Credenza pedestals file/file; ship assembled
- Additional pre-assembled units: TOW12 & TOW13
- Ship in two cartons: TOW84 72" Hutch & TOW59 48" Round Table

Features

- Integrated, felt-lined center drawer on all desk tops
- Keyboard Tray included with all bridges, returns and double pedestal credenzas
- Matching drawer interiors
- Felt-lined box drawers
- Full-extension file drawers with legal/letter filing
- Single-key locking located on inside of pedestals; front-locking lateral file and storage cabinet
- Wire management on tops and modesty panels of returns, bridge and credenzas

- Vertical heights 75" (30"H worksurfaces; 45"H hutches)
- Bookcase features 1" thick shelves; 4 adjustable, 2 fixed
- Hutch cabinets include 2 adjustable shelves and wood-frame glass door
- Hutch shelves are adjustable, 3 positions within a 5" range
- Hutch includes wire passage at worksurface and light valance
- Open Hutch fits both lateral file and storage cabinet

Conference

- 6', 8', 10' & 12' rectangular & 48" round tables
- Choice of Queen Anne or leg/pedestal base
- Queen Anne bases require assembly
- Queen Anne tables assemble without stretchers

Reception

- Reception unit (Tow-126) fits 72"x36" desks
- Features matching top/edge design as worksurfaces

Mendocino

Wood Characteristics

- Cherry tops feature book-matched American Cherry veneer
- Mahogany tops featured figured veneer
- All tops included contrasting black route line
- Lumber-banded hardwood edges with multistep, reverse-bevel design
- Coordinating veneer vertical surfaces

Finishes

- Satin Cherry or Mahogany

Design Details

- Shaped, floor-level wood trim on all pedestals
- Metal drawer pulls in brushed nickel

Construction

- Mendocino features 1 11/16" tops and 3/4" modesty panels.
- Metal-to-metal connection of tops and pedestals
- False pedestals required in connection corners of L and U shape configurations
- All pedestals ship assembled

Office

- Legal-width drawers on 72" & 84" desks
- Pedestals include single-key locking, pre-installed filing hardware for legal/letter filing and full-extension, ball-bearing drawer slides
- False pedestals required in connection corners of L and U shape configurations

- 79" vertical storage heights
- Center drawer & keyboard tray

Conference

- Racetrack tables 8', 10' & 12' with 1 1/8" thick tops and half-cylinder bases
- 48" Round table with full-cylinder base
- Bases feature floor-level wood trim

Reception

- Reception Main (MEN127) designed to fit 72x36 rectangular desk (MEN01)
- Reception Return (MEN128) designed to fit 48x24 return (MEN45)

Tuxedo

Materials

- Slate Grey or Dark Roast thermally-fused laminates
- Impact-resistant PVC edges
- Black laminate drawer interiors

Design Details

- Floating top design with angled edges
- Silver finish reveal and angled base trim
- Silver, solid-metal drawer pulls
- Silver electric/USB power units standard
- Inset modesty panels with aluminum frame and frosted glass

Construction

- 1-1/4"-thick tops
- Pedestals built with 4 full-finished sides and pre-installed base trim; ship fully assembled

- Breakfront modesty panels on desks with cam lock attachment
- Bridges & Returns pre-drilled for included electric/USB power unit
- Bridges & Returns require attachment of silver reveal and base trim
- Returns are left/right handed
- Hutches require assembly

Office

- Desktops include 2 black metal grommets
- Returns & Bridge include worksurface-height power unit with dual-electric, dual-USB plug-ins (silver finish)
- Bridge features curved cockpit style top
- Hutches feature 6 paper shelves; integrated cord-drop at base of back panel; and choice of wood or glass/aluminum doors

- Storage credenzas available with any combination of lateral file (12NT), multiframe (69NT) and storage cabinet (13NT) modules
- Pedestals include single-key locking, five-sided drawers, pre-installed metal filing hardware and full-extension, ball-bearing file drawers

Conference

- All table Tops include worksurface-height power unit with dual-electric, dual-USB plug-ins (silver finish)
- Table Bases ship assembled with cutout at top and grommet near bottom for wire management
- Table Bases are hollow top-to-bottom to accommodate floor power
- Square and rectangular tables can be created with modular table components
- Round table also available

Napa

Materials

- Scratch-resistant, textured thermally fused laminate surfaces with particleboard core
- Impact-resistant 3mm PVC edges
- Slate Grey, Urban Walnut, Espresso, Cherry, Mahogany & Maple
- Has achieved Greenguard Certification
- ANSI/BIFMA standards

Design Details

- Tri-groove edge design
- Black metal pulls; optional metallic finish pulls
- Metallic finish pulls standard on Espresso
- Full or 3/4 height hanging pedestals
- Matching drawer interiors

Construction

- Napa features 1-1/8" tops and end panels; 5/8" modesty panels

- All desk, return, bridge and credenza shells assemble with metal fasteners
- Pedestals ship assembled Additional pre-assembled units include NAP10, 12, 100, 109, 152, WM36 & WM48

Office

- Contour shaped worksurfaces: bullet desk; curved corner bullet desks; curved corner bow front desks; and curved corner credenzas
- All curved corner desks and credenzas are handed (left/right); plan accordingly
- Returns/bridges 36", 42" & 48" widths
- Wire management grommets on all worksurfaces
- Pedestals include single-key locking, five-sided drawer boxes, pre-installed filing hardware for legal/letter filing and full-extension, ball-bearing

drawer slides

- Combo file pedestal available
- 2 and 4-drawer lateral files with pre-installed metal filing hardware and anti-tilt feature
- Center drawer & keyboard tray

Conference

- Racetrack tables 6', 8', 10' & 12'
- 42" & 47" Round tables with X base
- All tables with 1.5"-thick tops and legs
- Complementing presentation board and storage cabinet

Reception

- Reception desk and return feature 41" high end and modesty panels
- Reception desk includes bow front transaction counter

Lodi

Materials

- Scratch-resistant, thermally fused laminate surfaces
- Impact-resistant PVC edges
- Cherry, Espresso & Urban Walnut matching laminate to Napa
- Urban Walnut with wood-grain embossed finish

Design Details

- Tri-groove reeded edge design
- Black metal pulls standard; optional metallic pulls (NAP-PM)
- Black grommets standard; optional metallic grommets (NAP-GM)
- Matching drawer interiors
- Hutch with choice of glass/aluminum, glass/wood or all-wood doors

Construction

- 1"-thick tops with 3mm PVC edgebanding
- 3/4"-thick end panels and 5/8"-thick modesty panels
- 3/4 modesty panels and pedestals
- All desk, return, bridge and credenza shells assemble with metal fasteners
- Pedestal ships assembled; screw into end panel and top

Features

- All desks, returns, bridges and credenzas can be installed left or right
- Wire management standard on worksurfaces
- Hutches with integrated 2" cord-drop at base of back panels
- 3/4 pedestals include single-key locking, five-sided drawers, pre-installed metal filing hardware and full-extension, ball-bearing file drawers

- Napa mobile pedestals in Cherry, Espresso and Urban Walnut fit Lodi desk shells

Lodi Complimentary Items

Reference the Lodi Complimentary Items page for coordinating Napa items.

- Napa conference tables feature 1.5"-thick tops and legs
- Other Napa units feature 1-1/8"-thick tops
- Select conference and reception furnishings, wall-mount overheads and several accessories:
 - NAPTB-3 Tackboard fits LOD41, LOD42 & LOD44 hutches
 - NAP14 Keyboard Tray
 - NAP15 Center Drawer
 - LK1-GC Replacement Lock Cores; KM-GC master and KC-GC change keys

ASCEND II

Materials

- Scratch-resistant, 1"-thick thermally fused laminate tops
- Impact-resistant 2mm PVC edges
- Steel bases with powdercoat finish

Design Details

- Bases in Silver & White
- Tops in Cherry, Espresso, Grey, Mahogany, Maple, Slate Grey, Urban Walnut & White
- 4', 5' and 6' x 24"D Tops
- 30" x 60" top; add A2FEET30 for 30"D tops

Construction

- Columns 2.75" x 2.75" with 1.5mm thick steel
- 22.8" deep, slope-style feet
- Width-adjustable center channel to accommodate 48"-72" tops
- 22.8" deep top supports

Features

- Handset with 3 programmable positions
- Anti-collision with sensitivity adjustment
- 36mm/s 0-100 lb. load, 32mm/s 100+ lb. load
- Sound level under 45DB without load
- Push-button adjustment
- 6' electrical cord
- UL962
- 5-year warranty

30"D Tops

- For 30"D tops, add optional A2FEET30 (set of 2)

Base (without top)	Height Range	Load Capacity	High/Low Position
A2EB322	25.5"	250 lb.	50" / 24.5"
A2EB333	25.5"	325 lb.	50" / 24.5"
A2EB222	17.3"	220 lb.	44.5" / 27.2"

PHAT

Materials

- Scratch-resistant thermally fused laminate surfaces with particleboard core
- Impact-resistant 2mm PVC edges
- 3" square steel column legs, 14 gauge steel
- Steel center and end supports, 14 gauge steel
- Black plastic 2.5" diameter, locking casters

Design Details

- Tops in Cherry, Espresso, Grey, Mahogany, Maple, Slate Grey, Urban Walnut & White
- Bases in Black, Titanium & White
- 4', 5' & 6'W x 24"D tables
- 30" x 60" tops available for 5' base
- Optional adjustable-height floor glides (HB4GLIDE)

Construction

- 1" thick tops with 2mm PVC edgebanding
- Tops and Bases sold, packed and shipped separately
- Simple assembly required
- Easy-roll, 2.5" diameter locking casters
- Stationary weight capacity 200 lbs.

Training Tables Folding/Nesting

Materials

- Scratch-resistant, thermally fused laminate surfaces
- Impact-resistant 2mm PVC edges
- Metal frame with powdercoat finish

- Legs made with 28mm-diameter steel tube; 2.3mm thick
- Modesty panel 22 gauge steel

Design Details

- Tops in Cherry, Espresso, Grey, Mahogany, Maple, Slate Grey, Urban Walnut & White
- Titanium & Black frames

- Modesty panel with decorative dot pattern
- 4', 5' & 6' x 24"D tables

Construction

- 1" tops with 2mm PVC edgebanding
- Tops and Frames sold/packed/shipped separately
- Simple assembly required
- 2.5" easy-roll, locking casters

Pace

Materials

- Scratch-resistant, textured thermally fused laminate surfaces with particleboard core
- Impact-resistant 3mm PVC edges

Design Details

- Mahogany & Fog/Charcoal Grey laminates with smooth PVC edges

- T-Arc and Post Legs with Black or Metallic powdercoat finish
- Optional modesty panels

Construction

- 1-1/8" tops and 5/8" modesty panels with metal inserts
- All components sold and packed/shipped individually

Training/Class/Computer

- 4', 5' & 6' tops @ 24" deep
- All tops feature metal inserts for Leg and Modesty Panel attachment
- Legs ship with levelers; optional casters available



PRO X 996
SERIES

Shown: 99662C-30
with HR33B Headrest

pro·line II®

Pro•Line II® is engineered for comfort, durability, and style. With a vast assortment of chairs and work space furnishings, this collection delivers flexible office solutions at an impressive price point.

pro·line II *Big & Tall and ProX996 Series*



★ **39200** Big and Tall Deluxe High Back Bonded Leather Executive Chair with Padded Flip Arms
Overall Size: 30W x 33.5D x 49H
Seat: 25.25W x 23.5D x 6T **Back:** 23.25W x 31H x 6T **Seat Range:** 20-24
Arms to Floor: 27.75 **Carton Wt:** 69 **UPS Wt:** 82 **COM:** N/A
Carton: 32L x 29W x 18H **Cube:** 9.6 **Options:** CG50, SW70
Features: 1, 4, 8, 9 **Control:** Locking Tilt
Notes:

Fabric	Updated List Price
Bonded Leather	775.00
Big & Tall 400 lbs.	



★ **39203** Big and Tall Deluxe High Back Black Fabric Executive Chair with Padded Flip Arms
Overall Size: 30W x 33.5D x 49H
Seat: 25.25W x 23.5D x 6T **Back:** 23.25W x 31H x 6T **Seat Range:** 20-24
Arms to Floor: 27.75 **Carton Wt:** 69 **UPS Wt:** 82 **COM:** N/A
Carton: 32L x 29W x 18H **Cube:** 9.6 **Options:** CG50, SW70
Features: 1, 4, 8, 9 **Control:** Locking Tilt
Notes:

Fabric	Updated List Price
Black Fabric	775.00
Big & Tall 400 lbs.	



★ **69220C-EC3** Big and Tall Mesh Back Black Bonded Leather Executive Chair with Adjustable Lumbar, and 2-Way Adjustable Flip Arms w/3-Position Adjustable Height
Overall Size: 28.75W x 28.75D x 41.75-45.75H
Seat: 23.5W x 22D x 6T **Back:** 22W x 29.75H **Seat Range:** 18-22
Arms to Floor: 28 **Carton Wt:** 86 **UPS Wt:** 86 **COM:** N/A
Carton: 30L x 27W x 18H **Cube:** 8.03 **Options:** CG50, SW70
Features: 1, 4, 8, 9 **Control:** Locking Tilt
Notes: Memory Foam Seat.

Fabric	Updated List Price
-EC3 Chrome/Black	775.00
Big & Tall 400 lbs.	



★ **69226-EC3** Big and Tall Mesh Back Black Bonded Leather Executive Chair with Adjustable Lumbar, and 2-Way Adjustable Flip Arms w/3-Position Adjustable Height
Overall Size: 28.75W x 28.75D x 41.75-45.75H
Seat: 23.5W x 22D x 6T **Back:** 22W x 29.75H **Seat Range:** 18-22
Arms to Floor: 28 **Carton Wt:** 68 **UPS Wt:** 79 **COM:** N/A
Carton: 30L x 27W x 20H **Cube:** 9.37 **Options:** CG50, SW70
Features: 1, 4, 8, 9 **Control:** Locking Tilt
Notes: Memory Foam Seat.

Fabric	Updated List Price
-EC3 Silver/Black	750.00
Big & Tall 400 lbs.	



★ **69227-3M** Big and Tall Mesh Back Black Mesh Seat Executive Chair with Adjustable Lumbar, and 2-Way Adjustable Flip Arms w/3-Position Adjustable Height
Overall Size: 28.75W x 28.75D x 41.75-45.75H
Seat: 23.5W x 22D x 6T **Back:** 22W x 29.75H **Seat Range:** 18-22
Arms to Floor: 28 **Carton Wt:** 68 **UPS Wt:** 79 **COM:** N/A
Carton: 30L x 27W x 20H **Cube:** 9.37 **Options:** CG50, SW70
Features: 1, 4, 8, 9 **Control:** Locking Tilt
Notes: Memory Foam Seat.

Fabric	Updated List Price
-3M Titanium/Black Mesh	750.00
A	800.00
B	842.00
C	888.00
R	935.00
Big & Tall 400 lbs.	



ProX996 Series



★ **99661W** Breathable White Vertical Mesh Back with Adjustable Back, Dual Steel Frame Post, Height & Width Adjustable Arms, and Polished Aluminum Base
Overall Size: 25.75W x 25.75D x 44-47H
Seat: 20.25W x 17.25D x 2T **Back:** 20W x 29.25H **Seat Range:** 19-22
Arms to Floor: 25.75 **Carton Wt:** 65 **UPS Wt:** 76 **COM:** 0.75 yd
Carton: 35L x 26W x 17H **Cube:** 8.95 **Options:** CG50, SW70
Features: 1, 4, 8, 9, 15 **Control:** 2-to-1 Synchro Tilt with 3-Position Lock
Notes: Optional Adjustable HR31W Headrest. Patent Pending. 300 lbs. Weight Limit.
Seat Slider

Fabric	List Price
Polished Aluminum/5811 Steel	895.00
	940.00
(Seat Only)	

PRO X 996 SERIES



shown: 99667T-5811



★ **99662C** Breathable Black Vertical Mesh Back with Adjustable Back, Dual Steel Frame Post, Height & Width Adjustable Arms, and Polished Aluminum Base

⚙️ **Overall Size:** 25.25W x 25.5D x 41.5-44.75H
Seat: 20.55W x 19.5D x 2T **Back:** 20W x 24H **Seat Range:** 18.5-21.75
Arms to Floor: 26 **Carton Wt:** 65 **UPS Wt:** 76 **COM:** N/A
Carton: 35L x 26W x 17H **Cube:** 8.95 **Options:** CG50, SW70
Features: 1, 4, 8, 9, 15 **Control:** 2-to-1 Synchro Tilt with 3-Position Lock
Notes: Optional Adjustable HR33B Headrest. Patent Pending. 300 lbs. Weight Limit.

Seat Slider

Fabric	List Price
Polished Aluminum/-30 Coal FreeFlex®	850.00
-R107 Dillon Black	
 (Seat Only)	895.00



★ **99663B** Breathable Black Vertical Mesh Back with Adjustable Back, Dual Steel Frame Post, Height & Width Adjustable Arms, and Black Finish Base

⚙️ **Overall Size:** 25.75W x 25.75D x 44-47H
Seat: 20.25W x 17.25D x 2T **Back:** 20W x 29.25H **Seat Range:** 19-22
Arms to Floor: 25.75 **Carton Wt:** 65 **UPS Wt:** 76 **COM:** N/A
Carton: 35L x 26W x 17H **Cube:** 8.95 **Options:** CG50, SW70
Features: 1, 4, 8, 9, 15 **Control:** 2-to-1 Synchro Tilt with 3-Position Lock
Notes: Optional Adjustable HR33B Headrest. Patent Pending. 300 lbs. Weight Limit.

Seat Slider

Fabric	List Price
Polished Black/-30 Coal FreeFlex®	850.00
 (Seat Only)	895.00



★ **99666S** Breathable Silver Vertical Mesh Back with Adjustable Back, Dual Steel Frame Post, Height & Width Adjustable Arms, and Silver Finish Base

⚙️ **Overall Size:** 25.75W x 25.75D x 44-47H
Seat: 20.25W x 17.25D x 2T **Back:** 20W x 29.25H **Seat Range:** 19-22
Arms to Floor: 25.75 **Carton Wt:** 65 **UPS Wt:** 76 **COM:** N/A
Carton: 35L x 26W x 17H **Cube:** 8.95 **Options:** CG50, SW70
Features: 1, 4, 8, 9, 15 **Control:** 2-to-1 Synchro Tilt with 3-Position Lock
Notes: Optional Adjustable HR36S Headrest. Patent Pending. 300 lbs. Weight Limit.

Seat Slider

Fabric	List Price
Silver/-30 Coal FreeFlex®	850.00
 (Seat Only)	895.00



★ **99667T** Breathable Silver Vertical Mesh Back with Adjustable Back, Dual Steel Frame Post, Height & Width Adjustable Arms, and Titanium Finish Base

⚙️ **Overall Size:** 25.75W x 25.75D x 44-47H
Seat: 20.25W x 17.25D x 2T **Back:** 20W x 29.25H **Seat Range:** 19-22
Arms to Floor: 25.75 **Carton Wt:** 65 **UPS Wt:** 76 **COM:** N/A
Carton: 35L x 26W x 17H **Cube:** 8.95 **Options:** CG50, SW70
Features: 1, 4, 8, 9, 15 **Control:** 2-to-1 Synchro Tilt with 3-Position Lock
Notes: Optional Adjustable HR36S Headrest. Patent Pending. 300 lbs. Weight Limit.

Seat Slider

Fabric	List Price
Titanium/5811 Steel	850.00
 (Seat Only)	895.00

PRO X 996 SERIES

adjustable height back

breathable vertical mesh back

self-adjusting lumbar support

height and width adjustable padded arms

steel frame post

2-to-1 synchro tilt mechanism with 3-position lock

seat slider

heavy duty aluminum coated base



optional headrest available (HR31W, HR33B, HR36S)

*patent pending



★ **HR36S Silver Headrest, HR33B Black Headrest, HR31W White Headrest**
(Headrests Fit 9966 Series Chairs only)

Overall Size: 11.75W x 3.25D x 6.25H

Carton Wt: 3 UPS Wt: 5 COM: N/A
Carton: 12L x 12W x 7H Cube: 0.58

Notes: Headrests for 99661W, 99662C, 99663B, 99666S, and 99667T

HR31W fits 99661W

HR33B fits 99662C and 99663B

HR36S fits 99666S and 99667T

Fabric	List Price
Silver	55.00
Black	
White	



★ **SPX23590C** High Back Manager's Faux Leather Chair with Chrome Arms, and Chrome Base. Includes Removable Arm Sleeves.
Overall Size: 28.25W x 29.75D x 41.75 - 45.5H
Seat: 20.5W x 19.25D x 3.5T **Back:** 20.5W x 24.75H x 3.5T **Seat Range:** 19-22.75
Arms to Floor: 25.75 **Carton Wt:** 36 **UPS Wt:** 48 **COM:** N/A
Carton: 27L x 26W x 14H **Cube:** 5.68 **Options:** CG50, SW70
Features: 1, 4, 5, 8, 9 **Control:** Locking Tilt
Notes: ★ NJ In-Stock: -U6 and -U11

Fabric	Updated List Price
Faux Leather -U1 Espresso -U6 Black -U9 Red -U11 White -U42 Charcoal Grey	535.00



★ **SPX23591C** Mid Back Manager's Faux Leather Chair with Chrome Arms, and Chrome Base. Includes Removable Arm Sleeves.
Overall Size: 25.25W x 24.5D x 37.25 - 41H
Seat: 20.5W x 19.25D x 3.5T **Back:** 20.5W x 19.75H x 3.5T **Seat Range:** 19-22.75
Arms to Floor: 25.75 **Carton Wt:** 34 **UPS Wt:** 41 **COM:** N/A
Carton: 25L x 24W x 14H **Cube:** 4.86 **Options:** CG50, SW70
Features: 1, 4, 5, 8, 9 **Control:** Locking Tilt
Notes: ★ NJ In-Stock: -U6 and -U11

Fabric	Updated List Price
Faux Leather -U1 Espresso -U6 Black -U9 Red -U11 White -U42 Charcoal Grey	480.00



★ **SPX23592C** Armless Mid Back Manager's Faux Leather Chair with Chrome Base
Overall Size: 25.25W x 23.5D x 37 - 40.75H
Seat: 20W x 19D x 2T **Back:** 19W x 15.5H x 2T **Seat Range:** 18.5-22.25
Arms to Floor: N/A **Carton Wt:** 29 **UPS Wt:** 76 **COM:** N/A
Carton: 26L x 25W x 24H **Cube:** 9.02 **Options:** CG50, SW70
Features: 1, 4, 5, 8, 9 **Control:** Locking Tilt
Notes: ★ NJ In-Stock: -U6 and -U11

Fabric	Updated List Price
Faux Leather -U1 Espresso -U6 Black -U9 Red -U11 White -U42 Charcoal Grey	425.00



★ **SPX23595C** Guest Faux Leather Chair with Chrome Arms, Matching Sleeves and Chrome Sled Base. Includes Removable Arm Sleeves.
Overall Size: 23.25W x 24.25D x 37.75H
Seat: 20W x 18D x 3.5T **Back:** 19.75W x 18.75H x 4.5T **Seat Range:** 19.75
Arms to Floor: 26 **Carton Wt:** 31 **UPS Wt:** 42 **COM:** N/A
Carton: 27L x 21W x 15H **Cube:** 4.92 **Options:** N/A
Features: N/A **Control:** N/A
Notes: ★ NJ In-Stock: -U6 and -U11

Fabric	Updated List Price
Faux Leather -U1 Espresso -U6 Black -U9 Red -U11 White -U42 Charcoal Grey	455.00



★ **7270** Deluxe High Back Executive White Leather Chair with Polished Aluminum Base and Padded Polished Aluminum Arms
Overall Size: 25W x 26.25D x 45-47.25H
Seat: 19.75W x 18.5D x 4T **Back:** 19.75W x 26.5H x 4T **Seat Range:** 18.5-20.75
Arms to Floor: 26.5 **Carton Wt:** 57 **UPS Wt:** 62 **COM:** N/A
Carton: 35L x 26W x 14D **Cube:** 7.37 **Options:** CG50, SW70
Features: 1, 4, 6, 8, 9 **Control:** Mid Pivot Knee Tilt
Notes: Dual Wheel Carpet Casters

Fabric	List Price
White Top Grain Leather	695.00



★ **7271** Deluxe Mid Back Executive White Leather Chair with Polished Aluminum Base and Padded Polished Aluminum Arms
Overall Size: 24.75W x 26.75D x 38.75-41.5H
Seat: 20.25W x 18.75D x 4T **Back:** 18.75W x 20.25H x 4T **Seat Range:** 18-20.5
Arms to Floor: 26 **Carton Wt:** 53 **UPS Wt:** 59 **COM:** N/A
Carton: 31L x 26W x 15H **Cube:** 7.0 **Options:** CG50, SW70
Features: 1, 4, 6, 8, 9 **Control:** Mid Pivot Knee Tilt
Notes: Dual Wheel Carpet Casters

Fabric	List Price
White Top Grain Leather	650.00



★ 7275 Deluxe Mid Back Visitor's White Leather Chair with Chrome Base and Padded Polished Aluminum Arms
 Overall Size: 25.75W x 27.25D x 37.25H
 Seat: 21W x 20D x 3.5T Back: 20W x 21H x 3.5T Seat Range: 18.5 Fixed
 Arms to Floor: 27 Carton Wt: 52 UPS Wt: 58 COM: N/A
 Carton: 31L x 24W x 16H Cube: 6.88 Options: N/A
 Features: N/A Control: N/A
 Notes:

Fabric	List Price
White Top Grain Leather	595.00



★ 8200 Deluxe High Back Executive Leather Chair with Polished Aluminum Base and Padded Polished Aluminum Arms
 Overall Size: 25W x 26.25D x 45-47.25H
 Seat: 19.75W x 18.5D x 4T Back: 19.75W x 26.5H x 4T Seat Range: 18.5-20.75
 Arms to Floor: 26.5 Carton Wt: 57 UPS Wt: 62 COM: N/A
 Carton: 35L x 26W x 14D Cube: 7.37 Options: CG50, SW70
 Features: 1, 4, 6, 8, 9 Control: Mid Pivot Knee Tilt
 Notes: Dual Wheel Carpet Casters

Fabric	List Price
Black Top Grain Leather	695.00



★ 8201 Deluxe Mid Back Executive Leather Chair with Polished Aluminum Base and Padded Polished Aluminum Arms
 Overall Size: 24.75W x 26.75D x 38.75-41.5H
 Seat: 20.25W x 18.75D x 4T Back: 18.75W x 20.25H x 4T Seat Range: 18-20.5
 Arms to Floor: 26 Carton Wt: 53 UPS Wt: 59 COM: N/A
 Carton: 31L x 26W x 15H Cube: 7.0 Options: CG50, SW70
 Features: 1, 4, 6, 8, 9 Control: Mid Pivot Knee Tilt
 Notes: Dual Wheel Carpet Casters

Fabric	List Price
Black Top Grain Leather	650.00



★ 8205 Deluxe Mid Back Leather Visitor's Chair with Chrome Base and Padded Polished Aluminum Arms
 Overall Size: 25.75W x 27.25D x 37.25H
 Seat: 21W x 20D x 3.5T Back: 20W x 21H x 3.5T Seat Range: 18.5 Fixed
 Arms to Floor: 28.25 Carton Wt: 52 UPS Wt: 54 COM: N/A
 Carton: 28L x 23W x 17H Cube: 6.33 Options: N/A
 Features: N/A Control: N/A
 Notes:

Fabric	List Price
Black Top Grain Leather	595.00

8500's



★ 8500 Deluxe High Back Executive Leather Chair with Steel Base Covered with Mahogany Finish Wood and Padded Mahogany Finish Wood Arms
 Overall Size: 26.5W x 31.5D x 46.25H
 Seat: 21.5W x 22D x 5T Back: 21.5W x 26.5H x 5T Seat Range: 19.75-22.5
 Arms to Floor: 28 Carton Wt: 61 UPS Wt: 67 COM: N/A
 Carton: 34L x 27W x 15H Cube: 7.96 Options: CG50, SW70
 Features: 1, 4, 6, 8, 9 Control: Deluxe Mid Pivot Knee Tilt
 Notes: Dual Wheel Carpet Casters

Fabric	Updated List Price
Black Top Grain Leather	785.00



★ 8501 Deluxe Mid Back Executive Leather Chair with Steel Base Covered with Mahogany Finish Wood and Padded Mahogany Finish Wood Arms
 Overall Size: 26.5W x 31.5D x 42H
 Seat: 21.5W x 22D x 5T Back: 20W x 22H x 3.5T Seat Range: 19.75-22.5
 Arms to Floor: 28 Carton Wt: 58 UPS Wt: 58 COM: N/A
 Carton: 30L x 26W x 15H Cube: 6.77 Options: CG50, SW70
 Features: 1, 4, 6, 8, 9 Control: Deluxe Mid Pivot Knee Tilt
 Notes: Dual Wheel Carpet Casters

Fabric	Updated List Price
Black Top Grain Leather	745.00



★ **8505** Deluxe Mid Back Visitor's Leather Chair with Mahogany Finish

Overall Size: 26.5W x 31.5D x 38.75H
Seat: 21.5W x 22D x 5T **Back:** 20W x 22H x 3.5T **Seat Range:** 18.5 Fixed
Arms to Floor: 28 **Carton Wt:** 44 **UPS Wt:** 54 **COM:** N/A
Carton: 28L x 23W x 17H **Cube:** 6.33 **Options:** N/A
Features: N/A **Control:** N/A
Notes:

Fabric	Updated List Price
Black Top Grain Leather	585.00

Executive Ergonomic



★ **54666** Multi Shift Ergonomic Chair with 2-to-1 Control, Seat Slider, 2-Way Adjustable Arms and Titanium Finish Aluminum Base. 24/7 High Intensity Use Chair.

Overall Size: 27.75W x 27D x 41.5H
Seat: 20W x 18.5D x 3.75T **Back:** 18.5W x 19.5H x 3.75T **Seat Range:** 19.25 -22.5
Arms to Floor: 26 **Carton Wt:** 59 **UPS Wt:** 59 **COM:** N/A
Carton: 29L x 26W x 15H **Cube:** 6.54 **Features:** 1, 3, 4, 7, 8, 9, 15
Control: 3 Position Locking 2-to-1 Synchro Tilt with Seat Slider
Notes: Increased Foam Density for Added Durability.

Fabric	List Price
-231 Black Icon	475.00
Seat Slider	



★ **8511** High Back Ergonomic Chair with Multi-Function Control, Seat Slider, Ratchet Back, 2-Way Adjustable Arms and Titanium Finish Aluminum Base

Overall Size: 28.25W x 24D x 44.75H
Seat: 21.25W x 19D x 4T **Back:** 20W x 24.25H x 3.5T **Seat Range:** 18.5-22
Arms to Floor: 25 **Carton Wt:** 63 **UPS Wt:** 63 **COM:** 1.75 yds
Carton: 27L x 26W x 16H **Cube:** 6.5 **Options:** CG50, SW70
Features: 1, 2, 4, 8, 13, 15 **Control:** Multi-Function with Seat Slider
Notes: Oversized Dual Wheel Carpet Casters. ★ -231 Only Available in NJ

Fabric	List Price
A	538.00
B	566.00
C	596.00
R	628.00



★ **8512** Mid Back Ergonomic Chair with Multi-Function Control, Seat Slider, Ratchet Back, 2-Way Adjustable Arms and Titanium Finish Aluminum Base

Overall Size: 27.25W x 24D x 42.5H
Seat: 21.25W x 19D x 4T **Back:** 19.75W x 22H x 3.5T **Seat Range:** 18.5-22
Arms to Floor: 25 **Carton Wt:** 63 **UPS Wt:** 55 **COM:** 1.5 yds
Carton: 27L x 26W x 16H **Cube:** 6.5 **Options:** CG50, SW70
Features: 1, 2, 4, 8, 13, 15 **Control:** Multi-Function with Seat Slider
Notes: Oversized Dual Wheel Carpet Casters. ★ NJ In-Stock: -231

Fabric	List Price
A	510.00
B	536.00
C	564.00
R	595.00

ProGrid® Series



⚙️ **2817** ProGrid® Mesh Back Armless Task Chair with Padded Fabric Seat, Ratchet Back and Pneumatic Control

Overall Size: 24W x 24D x 39.75H
Seat: 19.75W x 18D x 3T **Back:** 19W x 19H **Seat Range:** 17-22
Arms to Floor: N/A **Carton Wt:** 29 **UPS Wt:** 37 **COM:** 0.75 yd
Carton: 24L x 24W x 13H **Cube:** 4.33 **Options:** CG50, SW70, 04 Arms
Features: 1, 2, 4 **Control:** Pneumatic
Notes: Dual Wheel Carpet Casters

Fabric	List Price
-30 Coal FreeFlex®	275.00
A	290.00
B	305.00
C	320.00
R	355.00



⚙️ **28174** ProGrid® Mesh Back Task Chair with Padded Fabric Seat, Adjustable Arms, Ratchet Back and Pneumatic Control

Overall Size: 26.5W x 25.25D x 39H
Seat: 19.75W x 18D x 3T **Back:** 19W x 19H **Seat Range:** 17-22
Arms to Floor: 26 **Carton Wt:** 29 **UPS Wt:** 37 **COM:** 0.75 yd
Carton: 24L x 24W x 13H **Cube:** 4.33 **Options:** CG50, SW70
Features: 1, 2, 4 **Control:** Pneumatic
Notes: Dual Wheel Carpet Casters. 2817 with 04 Arms.

Fabric	List Price
-30 Coal FreeFlex®	340.00
A	355.00
B	370.00
C	385.00
R	420.00



★ **96610** ProGrid® Mesh Back Task Chair with Padded Fabric Seat, Adjustable Arms, Sliding Arm Pads, Seat Slider, Ratchet Back and Pneumatic Control
 Overall Size: 26.5W x 23.5D x 35-38.5H
 Seat: 20W x 18.5D x 1T Back: 19.25W x 19.75H Seat Range: 19-22.5
 Arms to Floor: 25.5 Carton Wt: 53 UPS Wt: 53 COM: 0.75 yd
 Carton: 27L x 25W x 14H Cube: 5.4 Options: CG50, SW70
 Features: 1, 4, 12, 15 Control: Self Adjusting
 Notes: Dual Wheel Carpet Casters. ★ NJ In-Stock: -30
 Seat Slider

Fabric	List Price
-30 Coal FreeFlex®	425.00
A	450.00
B	475.00
C	500.00
R	545.00



★ **2902** Ergonomic Task Chair with ProGrid® Mesh Back, Padded Fabric Seat and Multi-Task Control
 Overall Size: 25W x 25D x 39.75H
 Seat: 19.5W x 18.5D x 2.5T Back: 17.5W x 16.5H Seat Range: 18-23.5
 Arms to Floor: N/A Carton Wt: 33 UPS Wt: 40 COM: 0.5 yd
 Carton: 24L x 24W x 14H Cube: 4.66 Options: CG50, SW70, 04 Arms
 Features: 1, 2, 4, 10 Control: Multi-Task
 Notes: Dual Wheel Carpet Casters. ★ NJ In-Stock: -30

Fabric	List Price
-30 Coal FreeFlex®	290.00
A	305.00
B	320.00
C	335.00
R	375.00



★ **29024** Ergonomic Task Chair with ProGrid® Mesh Back, Padded Fabric Seat, Adjustable Arms and Multi-Task Control
 Overall Size: 25.75W x 25D x 39.75H
 Seat: 19.5W x 18.5D x 2.5T Back: 17.5W x 16.5H Seat Range: 18-23.5
 Arms to Floor: 25.5 Carton Wt: 40 UPS Wt: 40 COM: 0.5 yd
 Carton: 24L x 24W x 14H Cube: 4.66 Options: CG50, SW70
 Features: 1, 2, 4, 10 Control: Multi-Task
 Notes: Dual Wheel Carpet Casters. 2902 with 04 Arms.
 ★ NJ In-Stock: -30

Fabric	List Price
-30 Coal FreeFlex®	400.00
A	430.00
B	445.00
C	460.00
R	485.00



★ **98341** Ergonomic Task Chair with ProGrid® Mesh Back and Ratchet Back Height Adjustment without Arms and Dual Function Control
 Overall Size: 20W x 25.75D x 40.5H
 Seat: 20W x 18.5D x 3T Back: 19W x 19.5H Seat Range: 17-20.5
 Arms to Floor: N/A Carton Wt: 41 UPS Wt: 43 COM: 0.5 yd
 Carton: 25L x 25W x 14H Cube: 5.06 Options: CG50, SW70
 Features: 1, 2, 4, 11 Control: Dual Function
 Notes: Dual Wheel Carpet Casters. ★ NJ In-Stock: -30

Fabric	List Price
-30 Coal FreeFlex®	320.00
A	335.00
B	350.00
C	370.00
R	395.00



★ **98344** Ergonomic Task Chair with ProGrid® Mesh Back and Ratchet Back Height Adjustment, Adjustable Arms and Dual Function Control
 Overall Size: 25.5W x 25.75D x 40.5H
 Seat: 20W x 18.5D x 3T Back: 19W x 19.5H Seat Range: 17-20.5
 Arms to Floor: 25.5 Carton Wt: 48 UPS Wt: 50 COM: 0.5 yd
 Carton: 25L x 25W x 15H Cube: 5.42 Options: CG50, SW70
 Features: 1, 2, 4, 11 Control: Dual Function
 Notes: Dual Wheel Carpet Casters. ★ NJ In-Stock: -30

Fabric	List Price
-30 Coal FreeFlex®	405.00
A	420.00
B	435.00
C	455.00
R	480.00



★ **511342AL** Grey ProGrid® Mesh High Back Chair with Seat Slider, Adjustable Arms with Depth Adjustable Pads and Polished Aluminum Base
 Overall Size: 26.5W x 27.75D x 42H
 Seat: 20W x 19.5D x 3T Back: 20W x 21H Seat Range: 17.5-21.5
 Arms to Floor: 25.25 Carton Wt: 51 UPS Wt: 52 COM: N/A
 Carton: 29L x 26W x 13H Cube: 5.67 Options: SW392, HRX52
 Features: 1, 3, 4, 7, 8, 9, 15 Control: 3 Position Locking 2-to-1 Synchro Tilt
 Notes: Oversized Dual Wheel Carpet Casters
 With Headrest use Model #511342ALHRX52
 Seat Slider

Fabric	Updated List Price
Grey ProGrid® Back and Grey Fabric Seat	665.00



★ **511343AT** Black ProGrid® Mesh High Back Chair with Seat Slider, Adjustable Arms with Depth Adjustable Pads and Aluminum Base with Titanium Finish

Overall Size: 26.25W x 26D x 38-42.25H
Seat: 19.25W x 19.5D x 2.5T **Back:** 18.75W x 21.75H **Seat Range:** 17.5-21.5
Arms to Floor: 25 **Carton Wt:** 53 **UPS Wt:** 53 **COM:** 0.75 yd
Carton: 30L x 25W x 13H **Cube:** 5.64 **Options:** SW392, HRX53
Features: 1, 3, 4, 7, 8, 9, 15 **Control:** 3 Position Locking 2-to-1 Synchro Tilt
Notes: Oversized Dual Wheel Carpet Casters
With Headrest use Model #511343ATHRX53

Seat Slider

Fabric Black ProGrid® Back and Black Fabric Seat	Updated List Price 665.00
A	710.00
B	748.00
C	788.00
R	840.00



HRX52 Grey ProGrid® Headrest **HRX53** Black ProGrid® Headrest
(Headrests Fit 511342AL and 511343AT Chairs only)

★ **Overall Size:** 12.5W x 7D x 9H
Pad Size: 12.5W x 6.25H x 1T
Carton Wt: 2 **UPS Wt:** 4 **COM:** N/A
Carton: 13L x 10W x 6H **Cube:** 0.45

Notes: To Order Chair with Headrest , Use Model #'s 511342ALHRX52 for Grey or 511343ATHRX53 for Black

Fabric Black or Grey ProGrid®	Updated List Price 55.00
--------------------------------------------	------------------------------------



80885AL ProGrid® Mesh Back Manager's Chair with Flip Arms, Mesh Fabric Seat, Self Adjusting Control and Polished Aluminum Base

Overall Size: 26.5W x 25.25D x 41.75H
Seat: 20W x 18D x 3T **Back:** 19.75W x 21H **Seat Range:** 19-22.75
Arms to Floor: 29.5 **Carton Wt:** 42 **UPS Wt:** 46 **COM:** N/A
Carton: 28L x 24W x 14H **Cube:** 5.44 **Options:** SW392
Features: 1, 4, 8, 9, 14 **Control:** Self Adjusting Synchro Tilt
Notes: Dual Wheel Carpet Casters

Fabric -3 Black Mesh Seat with ProGrid® Back	Updated List Price 525.00
--------------------------------------------------------------	-------------------------------------



★ **92553** ProGrid® Mesh Back Manager's Chair with Height Adjustable Arms, Ratchet Back and Fabric Seat

⚙️ **Overall Size:** 27W x 25D x 42H
Seat: 20W x 18.75D x 3T **Back:** 19.5W x 20.75H **Seat Range:** 19.5-20.75
Arms to Floor: 25.75 **Carton Wt:** 44 **UPS Wt:** 44 **COM:** 0.75 yds
Carton: 25L x 25W x 14H **Cube:** 5.06 **Options:** CG50, SW70
Features: 1, 4, 7,8 **Control:** 2-to-1 Synchro Tilt
Notes: Nylon Base

NEW

Fabric -30 Coal FreeFlex®	List Price 375.00
A	395.00
B	415.00
C	438.00
R	485.00



★ **92343** ProGrid® Mesh Back Manager's Chair with 3-Way Adjustable Arms, Ratchet Back and Fabric Seat

⚙️ **Overall Size:** 26.5W x 25.25D x 39H
Seat: 20.25W x 19D x 3.5T **Back:** 19W x 16.75H **Seat Range:** 18.25-22
Arms to Floor: 25.5 **Carton Wt:** 50 **UPS Wt:** 50 **COM:** 0.75 yds
Carton: 25L x 25W x 14H **Cube:** 5.06 **Options:** CG50, SW70
Features: 1, 4, 11 **Control:** Dual Function
Notes: Dual Wheel Carpet Casters

Fabric -30 Coal FreeFlex®	List Price 400.00
A	415.00
B	435.00
C	460.00
R	495.00



★ **92893** ProGrid® Mesh Back Manager's Chair with 3-Way Adjustable Arms, Ratchet Back, Seat Slider and Fabric Seat

⚙️ **Overall Size:** 26.5W x 25.25D x 39H
Seat: 20.25W x 19D x 3.5T **Back:** 19W x 16.75H **Seat Range:** 18.25-22
Arms to Floor: 25.5 **Carton Wt:** 50 **UPS Wt:** 48 **COM:** 0.75 yds
Carton: 26L x 25W x 15H **Cube:** 5.64 **Options:** CG50, SW70
Features: 1, 3, 4, 13, 15 **Control:** Multi-Function w/Seat Slider
Notes: Dual Wheel Carpet Casters

Seat Slider

Fabric -30 Coal FreeFlex®	List Price 425.00
A	440.00
B	465.00
C	490.00
R	525.00



95672 and 95673 Seats are available in Fun Color Mesh Fabrics (Seat Only)



★ **95672** ProGrid® White Mesh High Back Chair with 2-Way Adjustable Arms, Ratchet Back, Deluxe 2-to-1 Synchro Tilt Control and Seat Slider
 Overall Size: 25.5W x 23.25D x 43 - 48.75H
 Seat: 20.25W x 20.75D x 3T Back: 20W x 27H Seat Range: 19.75 - 23
 Arms to Floor: 26.5 Carton Wt: 56 UPS Wt: 56 COM: 0.75 yds
 Carton: 29L x 25W x 15H Cube: 6.29 Options: CG50, SW70
 Features: 1, 2, 3, 4, 7, 8, 9, 15 Control: 3 Position Locking 2-to-1 Synchro Tilt
 Notes: Oversized Dual Wheel Carpet Casters
 Seat Slider

Fabric	List Price
ProGrid® Back and -5882 Dove Ivory Fabric Seat	550.00
(Seat only)	575.00



★ **95673** ProGrid® White Mesh Mid Back Chair with 2-Way Adjustable Arms, Ratchet Back, Deluxe 2-to-1 Synchro Tilt Control and Seat Slider
 Overall Size: 25.75W x 24.75D x 37.75 - 44H
 Seat: 20.5W x 20.25D x 3.5T Back: 19.5W x 19.75H Seat Range: 19-22.5
 Arms to Floor: 26.25 Carton Wt: 54 UPS Wt: 54 COM: 0.75 yds
 Carton: 27L x 25W x 14H Cube: 5.46 Options: CG50, SW70
 Features: 1, 2, 3, 4, 7, 8, 9, 15 Control: 3 Position Locking 2-to-1 Synchro Tilt
 Notes: Oversized Dual Wheel Carpet Casters
 Seat Slider

Fabric	List Price
ProGrid® Back and -5882 Dove Ivory Fabric Seat	525.00
(Seat only)	550.00



★ **8810W** ProGrid® Mesh Back with Padded Fabric Seat Visitor's Chair with Arms and White Finish Frame
 Overall Size: 25W x 25D x 37H
 Seat: 18.5W x 18D x 2.5T Back: 19.5W x 19.75H Seat Range: 19 Fixed
 Arms to Floor: 26.75 Carton Wt: 26 UPS Wt: 42 COM: .5 yds
 Carton: 34L x 23W x 11H Cube: 4.97 Options: SW72
 Features: N/A Control: N/A
 Notes:

Fabric	List Price
Fun Colors	290.00
(Seat only)	



8840W ProGrid® Mesh Back with Padded Fabric Seat Visitor's Chair with Arms, Casters and White Finish Frame
Overall Size: 25W x 24.5D x 36.75H
Seat: 18.5W x 18D x 2.5T **Back:** 19.5W x 18.5H **Seat Range:** 19 Fixed
Arms to Floor: 26.75 **Carton Wt:** 26 **UPS Wt:** 42 **COM:** .5 yds
Carton: 34L x 23W x 11H **Cube:** 4.97 **Options:** N/A
Features: N/A **Control:** N/A
Notes:

Fabric	List Price
Fun Colors	300.00



95512 ProGrid® Checkered Mesh Back with Adjustable Lumbar Support, 2-Way Adjustable Arms, Ratchet Back and Self Adjusting Mechanism
Overall Size: 26.25W x 27.5D x 36.5 - 40H
Seat: 20.25W x 19.75D x 3.25T **Back:** 19.75W x 19.5H **Seat Range:** 18.5-22
Arms to Floor: 25.5 **Carton Wt:** 51 **UPS Wt:** 53 **COM:** 0.75 yds
Carton: 29L x 25W x 13H **Cube:** 5.45 **Options:** CG50, SW70
Features: 1, 2, 4, 5, 9, 12 **Control:** Self Adjusting, Locking Tilt
Notes: Dual Wheel Carpet Casters.

Fabric	List Price
-30 Coal FreeFlex®	500.00
A	525.00
B	550.00
C	580.00
R	625.00
Self Adjusting Mechanism	



92583 ProGrid® Mesh Drafting Chair with Adjustable Footring and Dual Wheel Locking Carpet Casters
Overall Size: 27W x 24.75D x 41-50H
Seat: 20.5W x 19.25D **Back:** 19.75W x 19.75H **Seat Range:** 24.25-33.5
Arms to Floor: N/A **Carton Wt:** 45 **UPS Wt:** 50 **COM:** 0.5 yds
Carton: 27L x 26W x 14H **Cube:** 5.68 **Options:** CG50, SW70
Features: 1, 3, 4 **Control:** Pneumatic Height
Notes:

Fabric	List Price
-30 Coal FreeFlex®	425.00
A	450.00
B	475.00
C	500.00
R	550.00



90662 ProGrid® Mesh High Back Chair with 3-Way Adjustable Arms, 3 Position Locking 2-to-1 Synchro Tilt Control and Seat Slider
Overall Size: 26.5W x 27D x 43.5H
Seat: 20.25W x 19D x 3.5T **Back:** 19W x 22.25H **Seat Range:** 18.25-22
Arms to Floor: 25.5 **Carton Wt:** 51 **UPS Wt:** 55 **COM:** 0.75 yds
Carton: 31L x 26W x 14H **Cube:** 6.53 **Options:** CG50, SW70
Features: 1, 3, 4, 7, 8, 9, 15 **Control:** 3 Position Locking 2-to-1 Synchro Tilt
Notes: Dual Wheel Carpet Casters
Seat Slider

Fabric	List Price
-30 Coal FreeFlex®	425.00
A	440.00
B	465.00
C	490.00
R	525.00



92892 ProGrid® Mesh High Back Chair with 3-Way Adjustable Arms, Seat Slider, Multi-Function Control and Fixed Back
Overall Size: 26W x 29D x 42H
Seat: 21W x 19.5D x 3T **Back:** 19.5W x 23H **Seat Range:** 18.25-22
Arms to Floor: 25.5 **Carton Wt:** 57 **UPS Wt:** 57 **COM:** 0.75 yds
Carton: 31L x 25W x 13H **Cube:** 5.83 **Options:** CG50, SW70
Features: 1, 3, 4, 13, 15 **Control:** Multi-Function with Fixed Back
Notes: Dual Wheel Carpet Casters
Seat Slider

Fabric	List Price
-30 Coal FreeFlex®	460.00
A	480.00
B	505.00
C	530.00
R	570.00



93720 ProGrid® Mesh High Back Chair with 3-Way Adjustable Arms, Seat Slider and Synchro Control with Infinite Lock and Titanium Finish Aluminum Base
Overall Size: 27.75W x 27.25D x 44.25H
Seat: 20W x 18.5D **Back:** 21.25W x 23.25H **Seat Range:** 19.5-21.75
Arms to Floor: 26.25 **Carton Wt:** 64 **UPS Wt:** 71 **COM:** N/A
Carton: 37L x 26W x 15H **Cube:** 8.35 **Options:** CG50, SW70
Features: 1, 3, 4, 7, 8, 9, 15 **Control:** Synchro with Seat Slider
Notes: Dual Wheel Carpet Casters
Seat Slider

Fabric	List Price
ProGrid® Seat and Back	650.00

pro·line II® ProGrid® Series/Deluxe Stacking Chairs



★ 97720 ProGrid® Mesh High Back Chair with Fabric Seat, 3-Way Adjustable Arms, Seat Slider and Synchro Control with Infinite Lock and Titanium Finish Base

Overall Size: 27W x 25.75D x 46H
 Seat: 20.5W x 19.5D x 3.25T Back: 21.5W x 25.5H Seat Range: 18-20.75
 Arms to Floor: 25.75 Carton Wt: 67 UPS Wt: 71 COM: N/A
 Carton: 37L x 26W x 15H Cube: 8.35 Options: CG50, SW70
 Features: 1, 3, 4, 7, 8, 9, 15 Control: Synchro with Seat Slider
 Notes: Dual Wheel Carpet Casters. Cal 133 Compliant.

Seat Slider

Fabric	List Price
-30 Coal FreeFlex®	575.00
A	595.00
B	625.00
C	650.00
R	705.00



★ 97728 ProGrid® Mesh High Back Chair with Bonded Leather Seat, 3-Way Adjustable Arms, Seat Slider & Synchro Control with Infinite Lock and Titanium Finish Base

Overall Size: 28.5W x 24.5D x 43.5H
 Seat: 20.5W x 19D x 3.25T Back: 21.5W x 24.5H Seat Range: 18-20.25
 Arms to Floor: 24.75 Carton Wt: 59 UPS Wt: 71 COM: N/A
 Carton: 37L x 26W x 15H Cube: 8.35 Options: CG50, SW70
 Features: 1, 3, 4, 7, 8, 9, 15 Control: Synchro with Seat Slider
 Notes: Dual Wheel Carpet Casters

Seat Slider

Fabric	List Price
Bonded Leather -EC3 Black	595.00
-R105 Dillon Blue -R107 Dillon Black	595.00



★ 98346 ProGrid® Mesh Back Manager's Chair with Leather and Mesh Seat, 3-Way Adjustable Arms with Depth Adjustable Pads and Dual Function Control

Overall Size: 26.75W x 24.75D x 40.5H
 Seat: 20.5W x 19D x 3.5T Back: 19.75W x 20.5H Seat Range: 19-22.75
 Arms to Floor: 27 Carton Wt: 58 UPS Wt: 58 COM: N/A
 Carton: 25L x 25W x 15H Cube: 5.42 Options: CG50, SW70
 Features: 1, 4, 11 Control: Dual Function
 Notes: Dual Wheel Carpet Casters

Fabric	List Price
ProGrid® Back Black Leather and Mesh Fabric Seat	430.00



★ 85640 ProGrid® Mesh Back Visitor's Chair with Padded Fabric Seat, Contoured Arms, Casters and Titanium Finish Frame

Overall Size: 24.5W x 23.25D x 37.75H
 Seat: 17W x 19.75D x 2.25T Back: 19.75W x 20H Seat Range: 18.5 Fixed
 Arms to Floor: 26.75 Carton Wt: 24 UPS Wt: 40 COM: 0.75 yds
 Carton: 34L x 22W x 11H Cube: 4.76 Options: SW72
 Features: N/A Control: N/A
 Notes:

Fabric	List Price
-30 Coal FreeFlex®	260.00
A	275.00
B	290.00
C	305.00
R	330.00



★ 85670 ProGrid® Mesh Back Visitor's Chair with Padded Fabric Seat, Contoured Arms and Titanium Finish Frame

Overall Size: 24.5W x 23.25D x 37.75H
 Seat: 17W x 19.75D x 2.25T Back: 19.75W x 20H Seat Range: 18.5 Fixed
 Arms to Floor: 26.75 Carton Wt: 24 UPS Wt: 40 COM: 0.75 yds
 Carton: 34L x 22W x 11H Cube: 4.76 Options: N/A
 Features: N/A Control: N/A
 Notes:

Fabric	List Price
-30 Coal FreeFlex®	250.00
A	265.00
B	280.00
C	295.00
R	320.00



★ 84510 ProGrid® Mesh Back Visitor's Chair with Padded Fabric Seat, Contoured Arms and Titanium Finish Frame

Overall Size: 25.5W x 24D x 36.5H
 Seat: 18.5W x 19.5D x 3.25T Back: 20.75W x 21.75H Seat Range: 18.5 Fixed
 Arms to Floor: 26 Carton Wt: 23 UPS Wt: 39 COM: 0.7 yds
 Carton: 34L x 21W x 11H Cube: 4.54 Options: N/A
 Features: N/A Control: N/A
 Notes: Stacks with 84540

Fabric	List Price
-30 Coal FreeFlex®	290.00
A	305.00
B	320.00
C	335.00
R	360.00



★ **84540** ProGrid® Mesh Back Visitor's Chair with Padded Fabric Seat, Arms, Casters and Titanium Finish Frame

⚙️ **Overall Size:** 25.5W x 24D x 36.5H
Seat: 18.5W x 19.5D x 3.25T **Back:** 20.75W x 21.75H **Seat Range:** 18.5 Fixed
Arms to Floor: 26 **Carton Wt:** 23 **UPS Wt:** 39 **COM:** 0.7 yds
Carton: 34L x 21W x 11H **Cube:** 4.54 **Options:** SW72
Features: N/A **Control:** N/A
Notes: Stacks with w

Fabric -30 Coal FreeFlex®	List Price
A	315.00
B	330.00
C	345.00
R	370.00



★ **86724** ProGrid® Mesh Back Visitor's Chair with Padded Fabric Seat and Titanium Finish Frame

⚙️ **Overall Size:** 20.25W x 24D x 33.25H
Seat: 18W x 19D x 3T **Back:** 19W x 15H **Seat Range:** 17.25 Fixed
Arms to Floor: N/A **Carton Wt:** 19 **UPS Wt:** 25 **COM:** 0.75 yds
Carton: 27L x 21W x 9H **Cube:** 2.95 **Options:** N/A
Features: N/A **Control:** N/A
Notes: Stacking

Fabric -30 Coal FreeFlex®	List Price
A	210.00
B	220.00
C	235.00
R	253.00



★ **86725** ProGrid® Mesh Back Visitor's Chair with Padded Fabric Seat, Titanium Finish Sled Base

⚙️ **Overall Size:** 20.25W x 23.5D x 33H
Seat: 18W x 18.75D x 2.75T **Back:** 17.25W x 15H **Seat Range:** 18.75 Fixed
Arms to Floor: N/A **Carton Wt:** 23 **UPS Wt:** 26 **COM:** 0.75 yds
Carton: 27L x 22W x 9H **Cube:** 3.09 **Options:** N/A
Features: N/A **Control:** N/A
Notes: Stacking

Fabric -30 Coal FreeFlex®	List Price
A	230.00
B	240.00
C	255.00
R	295.00



★ **8455** Visitor's Chair with Ventilated Plastic Back and Black FreeFlex® -30 Seat with Chrome Sled Base

⚙️ **Overall Size:** 20.25W x 24D x 33.25H
Seat: 18.5W x 19D x 3T **Back:** 19W x 15H **Seat Range:** 17.75 Fixed
Weights: 248/65/35 **UPS Weights:** 100 (2-Pack Only)
Carton: 39L x 22W x 75H (20-Pack) 41L x 27W x 22H (4-Pack) 37L x 25W x 22H (2-Pack)
Cube: 37.23/14.09/11.77
Notes: Stacking and Ganging Sold in 20 Bulk pack w/Dolly, 4-Pack or 2-Pack

Fabric -30 Coal FreeFlex®	List Price
8455C20-30 (20 Pack w/Dolly)	2530.00
8455C4-30 (4-Pack)	540.00
8455C2-30 (2-Pack)	290.00



★ **82720** Upholstered Contour Back Armless Visitor's Chair with Titanium Finish Frame

⚙️ **Overall Size:** 20.5W x 22.25D x 33.75H
Seat: 18W x 19.5D x 2.5T **Back:** 19W x 16.5H x 1T **Seat Range:** 18.75 Fixed
Arms to Floor: N/A **Carton Wt:** 21 **UPS Wt:** 30 **COM:** 1.0 yds
Carton: 29L x 23W x 9H **Cube:** 3.47 **Options:** N/A
Features: N/A **Control:** N/A
Notes: Stacks with Models 82710 and 82740.

Fabric -30 Coal FreeFlex®	List Price
A	190.00
B	200.00
C	215.00
R	230.00



★ **82710** Upholstered Contour Back Visitor's Chair with Arms and Titanium Finish Frame

⚙️ **Overall Size:** 24.75W x 23.25D x 34H
Seat: 18.25W x 18.25D x 1.5T **Back:** 19W x 13.75H x .5T **Seat Range:** 19 Fixed
Arms to Floor: 27 **Carton Wt:** 22 **UPS Wt:** 30 **COM:** 1.0 yds
Carton: 32L x 21W x 9H **Cube:** 3.5 **Options:** N/A
Features: N/A **Control:** N/A
Notes: Stacks with Models 82720 and 82740.

Fabric -30 Coal FreeFlex®	List Price
A	205.00
B	215.00
C	230.00
R	245.00

pro·line II[®] Deluxe Stacking Chairs



★ **82740** Cal 133 Compliant Upholstered Seat and Back Visitor's Chair with Arms, Casters and Titanium Finish Frame
 Overall Size: 24.75W x 23.25D x 34H
 Seat: 18.25W x 18.25D x 1.5T Back: 19W x 13.75H x .5T Seat Range: 19 Fixed
 Arms to Floor: 27 Carton Wt: 20 UPS Wt: 33 COM: 1.0 yds
 Carton: 32L x 21W x 10H Cube: 3.88 Options: SW72
 Features: N/A Control: N/A
 Notes: Stacks with Models 82710 and 82720. ★ -30 Only Available in NJ

Fabric -30 Coal FreeFlex [®]	List Price
A	215.00
B	225.00
C	240.00
R	255.00



★ **86710** ProGrid[®] Mesh Back with Padded Fabric Seat Visitor's Chair with Arms and Titanium Finish Frame
 Overall Size: 25W x 23D x 34H
 Seat: 18W x 20D x 2T Back: 20W x 14.5H Seat Range: 18 Fixed
 Arms to Floor: 26.75 Carton Wt: 24 UPS Wt: 33 COM: .75 yds
 Carton: 32L x 21W x 10H Cube: 3.89 Options: N/A
 Features: N/A Control: N/A
 Notes: Stacks with Model 86740

Fabric -30 Coal FreeFlex [®]	List Price
A	215.00
B	225.00
C	240.00
R	255.00



★ **86740** ProGrid[®] Mesh Back with Padded Fabric Seat Visitor's Chair with Casters, Arms and Titanium Finish Frame
 Overall Size: 25W x 23D x 34H
 Seat: 18W x 20D x 2T Back: 20W x 14.5H Seat Range: 18 Fixed
 Arms to Floor: 26.75 Carton Wt: 20 UPS Wt: 33 COM: 0.75 yds
 Carton: 32L x 21W x 10H Cube: 3.89 Options: SW72
 Features: N/A Control: N/A
 Notes: Stacks with Models 82710 and 82720

Fabric -30 Coal FreeFlex [®]	List Price
A	225.00
B	235.00
C	250.00
R	265.00



★ **8610** Ventilated Plastic Wrap Around Back Visitor's Chair with Arms and Titanium Finish Frame
 Overall Size: 25W x 23D x 34H
 Seat: 18W x 20D x 2T Back: 20W x 14.5H Seat Range: 18 Fixed
 Arms to Floor: 26.75 Carton Wt: 19 UPS Wt: 33 COM: 0.75 yds
 Carton: 32L x 21W x 10H Cube: 3.89 Options: N/A
 Features: N/A Control: N/A
 Notes: Stacks with Models 8620 and 8640

Fabric -30 Coal FreeFlex [®]	List Price
A	195.00
B	205.00
C	220.00
R	235.00



★ **8620** Ventilated Plastic Wrap Around Back Armless Visitor's Chair with Titanium Finish Frame
 Overall Size: 20.5W x 23D x 34H
 Seat: 18W x 20D x 2T Back: 20W x 14.5H Seat Range: 18 Fixed
 Arms to Floor: N/A Carton Wt: 17 UPS Wt: 24 COM: 0.75 yds
 Carton: 26L x 21W x 9H Cube: 2.84 Options: N/A
 Features: N/A Control: N/A
 Notes: Stacks with Models 8610 and 8640

Fabric -30 Coal FreeFlex [®]	List Price
A	180.00
B	190.00
C	205.00
R	220.00



★ **8640** Ventilated Plastic Wrap Around Back Visitor's Chair with Arms, Casters and Titanium Finish Frame
 Overall Size: 25W x 23D x 34H
 Seat: 18W x 20D x 2T Back: 20W x 14.5H Seat Range: 18 Fixed
 Arms to Floor: 26.75 Carton Wt: 19 UPS Wt: 33 COM: 0.75 yds
 Carton: 32L x 21W x 10H Cube: 3.88 Options: SW72
 Features: N/A Control: N/A
 Notes: Stacks with Models 8610 and 8620

Fabric -30 Coal FreeFlex [®]	List Price
A	205.00
B	215.00
C	230.00
R	245.00



⚙️ **84230/84270 ProGrid® Checkered Mesh Back Folding Chair with Casters and Titanium or Black Finish Frame (2-Pack)**
 Overall Size: 26W x 23.25D x 36.5H
 Seat: 18W x 19D Back: 19W x 19H Seat Range: 19 Fixed
 Arms to Floor: 26.75 Carton Wt: 66 UPS Wt: 86 COM: 0.5 yds
 Carton: 27L x 27W x 24H Cube: 10.12 Options: SW72, CG60
 Features: N/A Control: N/A
 Notes:

Fabric	List Price
84230 Black Frame	
84270 Titanium Frame	
-30 Coal FreeFlex®	650.00
A	682.00
B	716.00
C	752.00
R	805.00



★ ⚙️ **84220 Deluxe ProGrid® Mesh Back Armless Folding Chair with Casters and Titanium Finish Frame (2-Pack)**
 Overall Size: 24W x 23.75D x 36.5H
 Seat: 18.25W x 19D x 2.5T Back: 21.5W x 20.75H Seat Range: 19.25 Fixed
 Arms to Floor: N/A Carton Wt: 56 UPS Wt: 65 COM: 0.75 yds
 Carton: 25L x 23W x 23H Cube: 7.65 Options: SW72, CG60
 Features: N/A Control: N/A
 Notes: Seat Folds up for Horizontal Nesting
 Sold in 2-Pack Only

Fabric	List Price
-30 Coal FreeFlex®	610.00
A	642.00
B	676.00
C	712.00
R	765.00



★ ⚙️ **84440 Deluxe ProGrid® Mesh Back Folding Chair with Arms, Casters and Titanium Finish Frame (2-Pack)**
 Overall Size: 24W x 23.75D x 36.5H
 Seat: 18.5W x 19D x 2.5T Back: 21.5W x 20.75H Seat Range: 19.25 Fixed
 Arms to Floor: 26.75 Carton Wt: 60 UPS Wt: 79 COM: 0.75 yds
 Carton: 26L x 26W x 24H Cube: 9.38 Options: SW72, CG60
 Features: N/A Control: N/A
 Notes: Seat Folds up for Horizontal Nesting
 Sold in 2-Pack Only

Fabric	List Price
-30 Coal FreeFlex®	650.00
A	682.00
B	716.00
C	752.00
R	805.00



★ ⚙️ **83220 Deluxe Ventilated Plastic Wrap Around Back Armless Folding Chair with Casters and Titanium Finish Frame (2-Pack)**
 Overall Size: 24.5W x 22D x 34H
 Seat: 18W x 19D x 2.5T Back: 18.5W x 14.25H Seat Range: 19.25 Fixed
 Arms to Floor: N/A Carton Wt: 55 UPS Wt: 62 COM: 0.75 yds
 Carton: 24L x 24W x 22H Cube: 7.33 Options: SW72, CG60
 Features: N/A Control: N/A
 Notes: Seat Folds up for Horizontal Nesting
 Sold in 2-Pack Only

Fabric	List Price
-30 Coal FreeFlex®	430.00
A	452.00
B	470.00
C	500.00
R	540.00



★ ⚙️ **84330 Ventilated Plastic Wrap Around Back Folding Chair with Arms, Casters and Titanium Finish Frame (2-Pack)**
 Overall Size: 24.5W x 22D x 34H
 Seat: 18W x 19D x 2.5T Back: 18.5W x 14.25H Seat Range: 19.25 Fixed
 Arms to Floor: 26.75 Carton Wt: 55 UPS Wt: 79 COM: 0.75 yds
 Carton: 26L x 26W x 24H Cube: 9.38 Options: SW72, CG60
 Features: N/A Control: N/A
 Notes: Seat Folds up for Horizontal Nesting
 Sold in 2-Pack Only. **Future Model Number Change: 84330R-30**

Fabric	List Price
-30 Coal FreeFlex®	470.00
A	492.00
B	516.00
C	540.00
R	580.00



★ **SW72 Soft Wheel Caster (set of 4)**
 ⚙️ **Carton Wt: 2 Cube: 0.2**
 🌿 **Designed For: 84540, 82740, 86740, 8640, 84220, 84230, 84270, 84440, 83220, and 84330**

List Price: 25.00 (set of 4)



⚙️ **CG60 Glides (Fixed Position - set of 4)**
 🌿 **Carton Wt: 2 Cube: 0.2**
 🌿 **Designed For: 84540, 82740, 86740, 8640, 84220, 84230, 84270, 84440, 83220, and 84330**

NEW

List Price: 25.00 (set of 4)



★ **SW70 Soft Wheel Caster (set of 5)**
 ⚙️ **Carton Wt: 2 Cube: 0.2**
 🌿 **Designed For: Most Work Smart & Space Chairs**
 🌿 **- See individual Chair Options**

List Price: 30.00 (set of 5)



⚙️ **81101 Deluxe ProGrid® Mesh Seat and Back Folding Chair with White Finish Frame (2-Pack)**
 🌿 **Overall Size: 20.25W x 22D x 34.25H**
Seat: 17.5W x 18.25D Back: 20.25W x 11H Seat Range: 17.75 Fixed
Arms to Floor: N/A Carton Wt: 30 UPS Weight: 37 COM: N/A
Carton: 45L x 21W x 8H Cube: 4.37 Options: N/A
Features: N/A Control: N/A
Notes: Sold in 2-Pack Only Gangable and Stackable. REPLACES Beige Frame. Patent# US D647,718 S

Fabric	List Price
ProGrid® Seat and Back	280.00 (2-Pack)
400 lbs.	



★ **81308 Deluxe ProGrid® Mesh Seat and Back Folding Chair with Black Finish Frame (2-Pack)**
 ⚙️ **Overall Size: 20.25W x 22D x 34.25H**
 🌿 **Seat: 17.5W x 18.25D Back: 20.25W x 11H Seat Range: 17.75 Fixed**
Arms to Floor: N/A Carton Wt: 32 UPS Weight: 31 COM: N/A
Carton: 43L x 21W x 7H Cube: 3.65 Options: N/A
Features: N/A Control: N/A
Notes: Sold in 2-Pack Only Gangable and Stackable. Patent# US D647,718 S

Fabric	List Price
ProGrid® Seat and Back	280.00 (2-Pack)
400 lbs.	



⚙️ **81608 Deluxe ProGrid® Mesh Seat and Back Folding Chair with Silver Finish Frame (2-Pack)**
 🌿 **Overall Size: 20.25W x 22.75D x 34.25H**
Seat: 17.5W x 18.25D Back: 20.25W x 11H Seat Range: 17.75 Fixed
Arms to Floor: N/A Carton Wt: 29 UPS Weight: 35 COM: N/A
Carton: 46L x 22W x 7H Cube: 3.65 Options: N/A
Features: N/A Control: N/A
Notes: Sold in 2-Pack Only Gangable and Stackable. Patent# US D647,718 S

Fabric	List Price
ProGrid® Seat and Back	280.00 (2-Pack)
400 lbs.	



 **HAT60241** 4 ft. Wide Pneumatic Height Adjustable Table with Locking Black Casters. Steel Frame/Laminate Top.

Overall Size: 47.25W x 23.5D x 30.25 - 43.25H
Height Minimum: 30.25 **Height Maximum:** 43.25
Carton Wt: 98 **UPS Wt:** 98
Carton: 50L x 26W x 7H **Cube:** 5.26 **Options:** HB4GLIDE
Static Load Weight Capacity: 200 lbs.
Notes: Complete Set.



HB4GLIDE
 Floor Glides (set of 4)
 Carton Wt: 1 Cube: 0.195
 Designed For: PHAT & HAT Tables
List Price: \$25 (set of 4)

Finish	List Price
HAT60241-1 White Frame/ White Top	825.00
HAT60241-U White Frame/ Urban Walnut Top	
HAT60243-M Black Frame/ Mahogany Top	
HAT60247-G Titanium Frame/ GreyTop	

 **HAT60251** 5 ft. Wide Pneumatic Height Adjustable Table with Locking Black Casters. Steel Frame/Laminate Top.

Overall Size: 59W x 23.5D x 30.25 - 43.25H
Height Minimum: 30.25 **Height Maximum:** 43.25
Carton Wt: 113 **UPS Wt:** 113
Carton: 62L x 26W x 7H **Cube:** 6.5 **Options:** HB4GLIDE
Static Load Weight Capacity: 200 lbs.
Notes: Complete Set. UPSable, Oversized Package



HB4GLIDE
 Floor Glides (set of 4)
 Carton Wt: 1 Cube: 0.195
 Designed For: PHAT & HAT Tables
List Price: \$25 (set of 4)

Finish	List Price
HAT60251-1 White Frame/ White Top	875.00
HAT60251-U White Frame/ Urban Walnut Top	
HAT60253-M Black Frame/ Mahogany Top	
HAT60257-G Titanium Frame/ GreyTop	

 **HAT60261** 6 ft. Wide Pneumatic Height Adjustable Table with Locking Black Casters. Steel Frame/Laminate Top.

Overall Size: 70.75W x 23.5D x 30.25 - 43.25H
Height Minimum: 30.25 **Height Maximum:** 43.25
Carton Wt: 127 **UPS Wt:** 127
Carton: 73L x 26W x 7H **Cube:** 7.68 **Options:** HB4GLIDE
Static Load Weight Capacity: 200 lbs.
Notes: Complete Set. UPSable, Oversized Package



HB4GLIDE
 Floor Glides (set of 4)
 Carton Wt: 1 Cube: 0.195
 Designed For: PHAT & HAT Tables
List Price: \$25 (set of 4)

Finish	List Price
HAT60261-1 White Frame/ White Top	950.00
HAT60261-U White Frame/ Urban Walnut Top	
HAT60263-M Black Frame/ Mahogany Top	
HAT60267-G Titanium Frame/ GreyTop	

PHT70523/PHT70527/PHT70521 Pneumatic Height Adjustable Table with White Dry-Erase Table Top

Overall Size: 47.25W x 23.5D x 41H
Height Minimum: 29 **Height Maximum:** 41
Carton Wt: 61 **UPS Wt:** 61
Carton: 49L x 25W x 5H **Cube:** 3.5 **Options:** N/A
Static Load Weight Capacity: 400 lbs. Distributed, 300 lbs. Concentrated
Notes: Color Finish Reflects Base Color



Finish	Updated List Price
PHT70523 Black	560.00
PHT70527 Titanium	
PHT70521 White	



HAT60251-1
with DC2990-231

★ **HZN25 Computer Desk with Keyboard Tray, Bronze Tempered Glass Top and Black Textured Powder Coated Frame**

⚙️ **Overall Size: 42W x 26D x 30H**

Carton Wt: 73 UPS Wt: 73
Carton: 43L x 29W x 9H Cube: 6.49 Options: N/A

Notes: Free Standing or Connect to HZN25L to make L Shape. L Shape Size is 78" x 68". Will Connect Left or Right.



Finish	Updated List Price
Black Textured Powder Coat and Bronze Glass	452.00

★ **HZN25L Side Desk with Corner Connector, Bronze Tempered Glass Top and Black Textured Powder Coated Frame**

⚙️ **Overall Size: 52W x 26D x 30H**

Corner Size: 26W x 26D
Carton Wt: 87 UPS Wt: 95
Carton: 55L x 32W x 7H Cube: 7.12 Options: N/A

Notes: Free Standing or Connect to HZN25 to make L Shape. L Shape Size is 78" x 68". Will Connect Left or Right.



Finish	List Price
Black Textured Powder Coat and Bronze Glass	495.00

⚙️ **HZN30 File Caddy with Casters, Glides Included**

Overall Size: 19.75W x 16D x 21H

Carton Wt: 9 UPS Wt: 10
Carton: 22L x 18W x 5H Cube: 1.14 Options: CG50, SW70

Notes: Holds Letter and Legal Size Hanging Folders



Finish	List Price
Black Textured Powder Coat	125.00



★ **PRD3060D** 60" Writing Desk with Black or White Laminate Top and Black or White Finish Metal Legs.



Overall Size: 60W x 30D x 29.5H
Desk Size: 60W x 30D x 1T

Carton Wt: 56 **UPS Wt:** 64
Carton: 64L x 34W x 6H **Cube:** 7.55 **Options:** N/A
Notes: UPSable, Oversized Package

Finish	Updated List Price
White (-WH) or Black (-BLK) Laminate	560.00

★ **PRD3060** L-Desk 60"W x 66"D in Black or White Laminate Top and Black or White Finish Metal Legs. L-Section Can Be Installed on Left or Right.



Overall Size: 60W x 65.75D x 29.75H
Desk Size: 60W x 30D x 29.75H

Return Size: 35.75W x 20D x 29.75H
Carton Wt: 101 **UPS Wt:** 101
Carton: 64L x 34W x 7H **Cube:** 8.8 **Options:** N/A
Notes: Return Will Connect Left or Right.

Finish (-BLK) Black Laminate Top and Legs	Updated List Price
(-WH) White Laminate Top and Legs	760.00

PRD6024 60" Desktop & Storage Unit with Black or White Laminate Top, Cabinet Storage and Pedestal.



Overall Size: 59.75W x 23.5D x 30H
Storage Size: 47.25W x 15.5D x 27.75H **Pedestal Size:** 15.5W x 23.5D x 27.75H
PRD6024A Carton 1 (Desk/Storage): 64L x 28W x 9H **Cube:** 9.3 **Wt:** 132 **UPS Wt:** 132
PRD6024B Carton 2 (Pedestal): 30L x 27W x 19H **Cube:** 8.9 **Wt:** 79 **UPS Wt:** 79

Notes:

Finish (-BLK) Black Laminate Top and Legs	List Price
(-WH) White Laminate Top and Legs	1050.00

★ NJ In Stock

	<p>★ PRD5215 Privacy Screen for Prado PRD3060 and PRD3060D with 2 Silver Mounting Brackets</p> <p>Overall Size: 52W x 15H</p> <p>Carton Wt: 11 UPS Wt: 13 Carton: 55L x 16W x 3H Cube: 1.4 Options: N/A</p> <p>Notes: Mounting Brackets Feature C-Clamp Design & Screw to Underside of Laminate Top.</p>	<p>Finish</p> <p>Translucent/ Silver Frame</p>	<p>Updated List Price</p> <p>295.00</p>
	<p>★ PRD2415 Privacy Screen for Prado Return and 30" Deep Prado Desks with 2 Silver Mounting Brackets</p> <p>Overall Size: 24W x 15H</p> <p>Carton Wt: 9 UPS Wt: 9 Carton: 29L x 16W x 3H Cube: 0.75 Options: N/A</p> <p>Notes: Mounting Brackets Feature C-Clamp Design & Screw to Underside of Laminate Top.</p>	<p>Finish</p> <p>Translucent/ Silver Frame</p>	<p>Updated List Price</p> <p>200.00</p>
	<p>★ PRDPOW1 Prado Power Unit with Two USB 3.0 and Two Electrical Outlets</p> <p>Overall Size: 3.2W x 3.2D x 2H</p> <p>Carton Wt: 2 UPS Wt: 2 Carton: 4L x 4W x 4H Cube: 0.03 Options: N/A</p> <p>Notes: Fits New Round Grommet Hole of PRD3060 and PRD3060D (80mm Diameter).</p>	<p>Finish</p> <p>Black</p>	<p>Updated List Price</p> <p>135.00</p>
	<p>★ PRDWIRE32 32"W Wire Management Tray, Black Plastic, Undersurface Mount. 2-Pack.</p> <p>Overall Size: 32W x 2.5D x 4H</p> <p>Carton Wt: 7 UPS Wt: 7 Carton: 36L x 8W x 5H Cube: 0.75 Options: N/A</p> <p>Notes: Fits Desk or Return on PRD3060 and PRD3060D.</p>	<p>Finish</p> <p>Black</p>	<p>Updated List Price</p> <p>75.00</p>
	<p>★ PRDFLAT Flat Bracket for Connecting Prado Units. 2-Pack.</p> <p>Overall Size: 2W x 3D</p> <p>Carton Wt: 2 UPS Wt: 2 Carton: 6L x 2W x 1H Cube: 0.006 Options: N/A</p> <p>Notes: Attaches to Underside of PRD3060 and PRD3060D.</p>	<p>Finish</p> <p>Black</p>	<p>Updated List Price</p> <p>15.95</p>
 <p>Black (-BLK)</p> <p>White (-WH)</p>	<p>★ PRD3529 Multiposition Desk Riser, 10-Position Manual Height Adjustment, Spring-Assist Lift, and Dual Handles in Black or White Finish</p> <p>Overall Size: 35.5W x 29D x 16.75H Worksurface: 35W x 20D Keyboard Platform: 26W x 13D</p> <p>Carton Wt: 68 UPS Wt: 68 Carton: 38L x 33W x 6H Cube: 4.35 Options: N/A</p> <p>Notes: Supports up to 33 lbs. Patent No. US 9,681,746 Fits 30"D Desks and Work Surfaces NO ASSEMBLY REQUIRED</p>	<p>Finish</p> <p>White (-WH) or Black (-BLK)</p>	<p>List Price</p> <p>495.00</p>



★ **PRD42RT** 42" Round Conference Table with Black or White Laminate Top and Metal Legs.

Overall Size: 42W x 42D x 29.5H

Desk Size: 42W x 42D x 1T

Carton Wt: 53 **UPS Wt:** 62

Carton: 46L x 46W x 6H **Cube:** 7.34 **Options:** N/A

Notes:

Finish	Updated List Price
White (-WH) or Black (-BLK) Laminate	425.00



PRD3230 30" High 2-Shelf Bookcase with 1 Adjustable Shelf, 3/4" Shelf Thickness in Black or White Laminate

Overall Size: 31.5W x 12D x 30H

Carton Wt: 47 **UPS Wt:** 47

Carton: 35L x 33W x 3H **Cube:** 2.0 **Options:** N/A

Notes:

Finish	Updated List Price
White (-WH) or Black (-BLK) Laminate	160.00



PRD3248 48" High 3-Shelf Bookcase with 2 Adjustable Shelves, 3/4" Shelf Thickness in Black or White Laminate

Overall Size: 31.5W x 12D x 48H

Carton Wt: 68 **UPS Wt:** 68

Carton: 49L x 33W x 3H **Cube:** 2.8 **Options:** N/A

Notes:

Finish	Updated List Price
White (-WH) or Black (-BLK) Laminate	225.00



PRD3260 60" High 4-Shelf Bookcase with 2 Adjustable and 2 Fixed Shelves, 3/4" Shelf Thickness in Black or White Laminate

Overall Size: 31.5W x 12D x 60H

Carton Wt: 86 **UPS Wt:** 86

Carton: 61L x 33W x 3H **Cube:** 3.49 **Options:** N/A

Notes:

Finish	Updated List Price
White (-WH) or Black (-BLK) Laminate	280.00



★ **PRD3085** Mobile File with Hidden Drawer and Casters

Overall Size: 15.5W x 19.5D x 28H

Carton Wt: 75 **UPS Wt:** 75

Carton: 29L x 22W x 19H **Cube:** 7.01 **Options:** N/A

Notes: Applicable for models PRD3060 L-Desk and PRD3060D Desk.

Finish	Updated List Price
White (-WH) or Black (-BLK) Laminate	480.00



Shown:
EM69200PN-6



Work Smart® offers workspace solutions through an extensive range of commercial products. Office seating, guest seating, reception, and lobby furnishings are offered to create the most flexible work environments. Engineered for productivity, efficiency, and the best in functionality and value.



33320 Mid Back Dual Function Ergonomic Chair with Ratchet Back Height Adjustment without Arms
 Overall Size: 20W x 20.5D x 39.25H
 Seat: 20W x 18.25D x 2.25T Back: 16.75W x 17H x 2.75T Seat Range: 17.5-21
 Arms to Floor: N/A Carton Wt: 49 UPS Wt: 41 COM: 1.0 yds
 Carton: 24L x 24W x 14H Cube: 4.66 Options: CG50, SW70
 Features: 1, 2, 4, 11 Control: Dual Function
 Notes:

Fabric	List Price
-30 Coal FreeFlex®	300.00
A	315.00
B	332.00
C	350.00
R	375.00



33327 Mid Back Dual Function Ergonomic Chair with Ratchet Back Height Adjustment and Height and Width Adjustable Arms
 Overall Size: 24.25W x 20.5D x 39.25H
 Seat: 20W x 18.25D x 2.25T Back: 16.75W x 17H x 2.75T Seat Range: 17.5-21
 Arms to Floor: 23.5 Carton Wt: 49 UPS Wt: 49 COM: 1.0 yds
 Carton: 24L x 24W x 14H Cube: 4.66 Options: CG50, SW70
 Features: 1, 2, 4, 11 Control: Dual Function
 Notes:

Fabric	List Price
-30 Coal FreeFlex®	385.00
A	400.00
B	417.00
C	435.00
R	460.00



33340 High Back Dual Function Ergonomic Chair with Ratchet Back Height Adjustment without Arms
 Overall Size: 20W x 20.5D x 42.25H
 Seat: 20W x 18.25D x 2.25T Back: 17.25W x 20H x 2.75T Seat Range: 17.5-21
 Arms to Floor: N/A Carton Wt: 42 UPS Wt: 44 COM: 1.0 yds
 Carton: 27L x 24W x 14H Cube: 5.25 Options: CG50, SW70
 Features: 1, 2, 4, 11 Control: Dual Function
 Notes:

Fabric	List Price
-30 Coal FreeFlex®	320.00
A	335.00
B	352.00
C	372.00
R	400.00



33347 High Back Dual Function Ergonomic Chair with Ratchet Back Height Adjustment and Height and Width Adjustable Arms
 Overall Size: 24.25W x 20.5D x 42.25H
 Seat: 20W x 18.25D x 2.25T Back: 17.25W x 20H x 2.75T Seat Range: 17.5-21
 Arms to Floor: 23.5 Carton Wt: 50 UPS Wt: 50 COM: 1.0 yds
 Carton: 27L x 24W x 14H Cube: 5.25 Options: CG50, SW70
 Features: 1, 2, 4, 11 Control: Dual Function
 Notes:

Fabric	List Price
-30 Coal FreeFlex®	405.00
A	420.00
B	437.00
C	453.00
R	490.00



36420 Dual Function Ergonomic Chair with Back Height Adjustment
 Overall Size: 18.5W x 23D x 44H
 Seat: 18.5W x 17.75D x 3.5T Back: 16W x 18.5H x 2.75T Seat Range: 15.25-20.5
 Arms to Floor: N/A Carton Wt: 50 UPS Wt: 50 COM: 0.8 yds
 Carton: 24L x 24W x 14H Cube: 4.66 Options: CG50, SW70
 Features: 1, 2, 4, 11 Control: Dual Function
 Notes:

Fabric	List Price
A	270.00
B	285.00
C	305.00
R	338.00



36427 Dual Function Ergonomic Chair with Back Height Adjustment and Height Adjustable Arms
 Overall Size: 24.5W x 23D x 44H
 Seat: 18.5W x 17.75D x 3.5T Back: 16W x 18.5H x 2.75T Seat Range: 15.25-20.5
 Arms to Floor: 24.25 Carton Wt: 45 UPS Wt: 45 COM: 0.8 yds
 Carton: 24L x 24W x 14H Cube: 4.66 Options: CG50, SW70
 Features: 1, 2, 4, 11 Control: Dual Function
 Notes:

Fabric	List Price
A	355.00
B	370.00
C	390.00
R	423.00



★ **8180 Sculptured Ergonomic Manager's Chair with Adjustable Arms**
 Overall Size: 22.75W x 23.5D x 34 - 39.5H
 Seat: 18.5W x 18D x 3.75T Back: 16.75W x 17H x 3T Seat Range: 18 - 22.75
 Arms to Floor: 24.5 Carton Wt: 43 UPS Wt: 43 COM: 0.8 yds
 Carton: 24L x 24W x 13H Cube: 4.33 Options: CG50, SW70, SK7, SK5
 Features: 1, 2, 4, 10 Control: Multi-Task
 Notes: ★ NJ In-Stock: -231

Fabric	List Price
A	295.00
B	310.00
C	334.00
R	360.00



★ **2907 High Back Multi Function Ergonomic Chair with Ratchet Back Height Adjustment and 2-Way Adjustable Arms**
 Overall Size: 25W x 25.25D x 32.25H
 Seat: 20.25W x 20.5D x 4.5T Back: 20W x 25.25H x 4.25T Seat Range: 17.75 -21.5
 Arms to Floor: 25.25 Carton Wt: 61 UPS Wt: 55 COM: 2.0 yds
 Carton: 29L x 26W x 15H Cube: 6.54 Options: CG50, SW70
 Features: 1, 2, 4, 8, 13 Control: Multi Function
 Notes: ★ NJ In-Stock: -231

Fabric	List Price
A	460.00
B	485.00
C	520.00
R	560.00



★ **3121 Mid Back 2-to-1 Synchro Tilt Ergonomic Chair with 2-Way Adjustable Soft Padded Arms and Molded Foam**
 Overall Size: 27.25W x 25.25D x 41.5H
 Seat: 20.5W x 19D x 3.5T Back: 19.5W x 21H x 3.5T Seat Range: 18.5 -22.25
 Arms to Floor: 24.75 Carton Wt: 50 UPS Wt: 54 COM: 1.0 yds
 Carton: 30L x 26W x 14H Cube: 6.31 Options: CG50, SW70
 Features: 1, 4, 7, 8, 9 Control: 2-to-1 Synchro Tilt
 Notes: ★ NJ In-Stock: -231

Fabric	List Price
A	350.00
B	370.00
C	398.00
R	425.00



★ **3121FB Mid Back 2-to-1 Synchro Tilt Ergonomic Chair with 2-Way Adjustable Soft Padded Arms and Molded Foam**
 Overall Size: 27.25W x 25.25D x 41.5H
 Seat: 20.5W x 19D x 3.5T Back: 19.5W x 21H x 3.5T Seat Range: 18.5 -22.25
 Arms to Floor: 24.75 Carton Wt: 46 UPS Wt: 50 COM: 1.0 yds
 Carton: 29L x 25W x 14H Cube: 5.87 Options: CG50, SW70
 Features: 1, 4, 7, 8, 9 Control: 2-to-1 Synchro Tilt
 Notes: Fabric Back

Fabric	List Price
A	365.00
B	385.00
C	428.00
R	455.00



★ **3121TB Cal 133 Compliant Mid Back 2-to-1 Synchro Tilt Ergonomic Chair with 2-Way Adjustable Soft Padded Arms and Molded Foam**
 Chair Specs: See 3121 above
 The 3121TB is available in the Following limited fabric selection
 A Grade: Icon, Diamond, Festival, Legend, Gavotte and Ridgcrest
 B Grade: Fine Tune and City Park
 Notes: Cal 133 Fire Barrier Compliant Fabric

Fabric	List Price
A	540.00
B	600.00



★ **43891 Mid Back Multi Function Chair with Ratchet Back Height Adjustment, Fabricated Back, Seat Slider and 2-Way Adjustable Arms**
 Overall Size: 29W x 27.25D x 45H
 Seat: 20W x 20D x 3.5T Back: 19W x 19H x 3.5T Seat Range: 18 -21.25
 Arms to Floor: 25.25 Carton Wt: 61 UPS Wt: 61 COM: 1.75 yds
 Carton: 27L x 26W x 15H Cube: 6.09 Options: CG50, SW70
 Features: 1, 2, 4, 8, 13, 15 Control: Multi Function
 Notes: This Chair has a Seat Slider and Forward Pitch. REPLACES 43801
 Seat Slider

Fabric	List Price
A	450.00
B	475.00
C	510.00
R	550.00



★ **43808** Multi Function Ergonomic Chair with Ratchet Back and Adjustable Soft Padded Arms
 ⚙️
 🌿
Overall Size: 25W x 25.5D x 34.25H
Seat: 20W x 20D x 3.5T **Back:** 19W x 19H x 3.5T **Seat Range:** 17.5 -21
Arms to Floor: 25.5 **Carton Wt:** 55 **UPS Wt:** 55 **COM:** 1.25 yds
Carton: 27L x 25W x 15H **Cube:** 5.85 **Options:** CG50, SW70, SK1, SK5
Features: 1, 2, 4, 8, 13 **Control:** Multi Function
Notes: ★ NJ In-Stock: -231

Fabric	List Price
A	415.00
B	438.00
C	470.00
R	510.00



★ **43819** Multi Function Ergonomic Chair with Ratchet Back and Adjustable Soft Padded Arms
 ⚙️
 🌿
Overall Size: 26.5W x 25.5D x 46.25H
Seat: 20W x 20D x 3.5T **Back:** 19W x 21.75H x 3.5T **Seat Range:** 18 -21.25
Arms to Floor: 26 **Carton Wt:** 56 **UPS Wt:** 56 **COM:** 1.0 yd
Carton: 27L x 26W x 15H **Cube:** 6.09 **Options:** CG50, SW70
Features: 1, 2, 4, 8, 13 **Control:** Multi Function
Notes: ★ NJ In-Stock: -231

Fabric	List Price
A	445.00
B	470.00
C	505.00
R	560.00



★ **43998** Dual Function Ergonomic Chair with Seat Slider, Ratchet Back and Adjustable Soft Padded Arms
 ⚙️
 🌿
Overall Size: 26.5W x 25.5D x 38.25H
Seat: 20W x 20D x 3.5T **Back:** 19W x 23H x 3.5T **Seat Range:** 17.5 -21
Arms to Floor: 25.5 **Carton Wt:** 55 **UPS Wt:** 55 **COM:** 1.0 yd
Carton: 27L x 25W x 15H **Cube:** 5.85 **Options:** CG50, SW70
Features: 1, 2, 4, 11, 15 **Control:** Dual Function
Notes: ★ NJ In-Stock: -231
 Seat Slider

Fabric	List Price
A	465.00
B	490.00
C	525.00
R	570.00

Executive Ergonomic Leather



★ **EC4300** Professional Dual Function Ergonomic High Back Bonded Leather Chair with Height Adjustable Padded Arms
 ⚙️
 🌿
Overall Size: 27.25W x 27.5D x 49H
Seat: 20.25W x 19.5D x 5T **Back:** 20.5W x 26.25H x 5T **Seat Range:** 18 -21.5
Arms to Floor: 25.25 **Carton Wt:** 56 **UPS Wt:** 61 **COM:** N/A
Carton: 31L x 25W x 16H **Cube:** 7.17 **Options:** CG50, SW70
Features: 1, 2, 4, 11 **Control:** Dual Function
Notes:

Fabric	List Price
Bonded Leather -EC3 Black -EC4 Burgundy	450.00
-R103 Dillon Stratus -R105 Dillon Blue -R107 Dillon Black	450.00



★ **EC4350** Deluxe Multi Function Ergonomic High Back Bonded Leather Chair with Ratchet Back Height and 2-Way Adjustable Arms
 ⚙️
 🌿
Overall Size: 27.25W x 26D x 48.5H
Seat: 20.25W x 19.5D x 5T **Back:** 20.5W x 26.25H x 5T **Seat Range:** 18 -21.5
Arms to Floor: 24.5 **Carton Wt:** 63 **UPS Wt:** 63 **COM:** N/A
Carton: 29L x 26W x 15H **Cube:** 6.54 **Options:** CG50, SW70
Features: 1, 2, 4, 8, 13 **Control:** Multi Function
Notes:

Fabric	List Price
Bonded Leather -EC3 Black	475.00
-R107 Dillon Black	475.00

Pneumatic Task Chairs



★ **33101** Deluxe Task Chair with Ratchet Back Height Adjustment without Arms
 ⚙️
 🌿
Overall Size: 20W x 23.25D x 41.5H
Seat: 20W x 18.25D x 2.25T **Back:** 16.75W x 17H x 2.75T **Seat Range:** 18.75 -24
Arms to Floor: N/A **Carton Wt:** 40 **UPS Wt:** 40 **COM:** 1.0 yds
Carton: 24L x 23W x 14H **Cube:** 4.47 **Options:** 07, CG50, SW70, SK7, SK5
Features: 1, 2, 3, 4 **Control:** Pneumatic
Notes:

Fabric	List Price
-30 FreeFlex®	260.00
A	275.00
B	290.00
C	305.00
R	330.00



33107 Deluxe Task Chair with Ratchet Back Height Adjustment and Height and Width Adjustable Arms

Overall Size: 24.25W x 23.25D x 41.5H
 Seat: 20W x 18.25D x 2.25T Back: 16.75W x 17H x 2.75T Seat Range: 18.75 -24
 Arms to Floor: N/A Carton Wt: 41 UPS Wt: 41 COM: 1.0 yds
 Carton: 24L x 23W x 14H Cube: 4.47 Options: CG50, SW70, SK7, SK5
 Features: 1, 2, 3, 4 Control: Pneumatic
 Notes:

Fabric	List Price
-30 Coal FreeFlex®	345.00
A	360.00
B	375.00
C	390.00
R	415.00



8120 Sculptured Task Chair

Overall Size: 20W x 23.25D x 40H
 Seat: 18.5W x 18.25D x 3T Back: 17W x 15.5H x 3T Seat Range: 17.25 -22.25
 Arms to Floor: N/A Carton Wt: 29 UPS Wt: 33 COM: 0.8 yds
 Carton: 24L x 23W x 12H Cube: 3.83 Options: 07, CG50, SW70, SK7, SK5
 Features: 1, 2, 3, 4 Control: Pneumatic
 Notes: ★ NJ In-Stock: -231

Fabric	List Price
A	220.00
B	232.00
C	245.00
R	265.00



DH3400 Contemporary Task Chair with Flex Back

Overall Size: 22.25W x 24.5D x 42H
 Seat: 20W x 19.25D x 2.25T Back: 17.75W x 18.5H x 2.5T Seat Range: 15.75-19.25
 Arms to Floor: N/A Carton Wt: 32 UPS Wt: 40 COM: 0.8 yds
 Carton: 24L x 24W x 14H Cube: 4.66 Options: CG50, SW70, SK7, SK5
 Features: 1, 2, 3, 4, 12 Control: Pneumatic
 Notes:

Fabric	List Price
A	250.00
B	265.00
C	280.00
R	300.00

Specialty Seating



TND940A Trinidad High Back Office Chair with Fixed Padded Arms and Chrome Finish Base and Accents

Overall Size: 21.75W x 22D x 46.5H
 Seat: 18.5W x 15.75D Back: 18.25W x 24.25H Seat Range: 18.25 - 23
 Arms to Floor: 27.5 Carton Wt: 32 UPS Wt: 69 COM: N/A
 Carton: 34L x 26W x 16H Cube: 8.18 Options: CG50, SW70
 Features: 1, 4, 5, 8, 9 Control: Locking Tilt
 Notes: ★ NJ In-Stock: -WH

Fabric	Updated List Price
-ES Espresso	420.00
-BK Black	
-WH White	
-RD Red	
-CRM Cream	
250 lbs.	



TND941A Trinidad Office Chair with Fixed Padded Arms and Chrome Finish Base and Accents

Overall Size: 22W x 23D x 41H
 Seat: 18.25W x 16D Back: 19.5W x 18.25H Seat Range: 18.5 - 23.25
 Arms to Floor: 27.75 Carton Wt: 32 UPS Wt: 55 COM: N/A
 Carton: 31L x 24W x 15H Cube: 6.45 Options: CG50, SW70
 Features: 1, 4, 5, 8, 9 Control: Locking Tilt
 Notes: ★ NJ In-Stock: -WH

Fabric	Updated List Price
-ES Espresso	388.00
-BK Black	
-WH White	
-RD Red	
-CRM Cream	
250 lbs.	



TND945A Trinidad Visitor's Chair with Fixed Padded Arms and Chrome Finish Base and Accents

Overall Size: 21.5W x 22.75D x 36H
 Seat: 18.5W x 16.25D Back: 18.25W x 17.75H Seat Range: 18.25 Fixed
 Arms to Floor: 27 Carton Wt: 28 UPS Wt: 92 COM: N/A
 Carton: 37L x 23W x 22H Cube: 10.83 Options: N/A
 Features: N/A Control: N/A
 Notes: ★ NJ In-Stock: -WH

Fabric	Updated List Price
-ES Espresso	420.00
-BK Black	
-WH White	
-RD Red	
-CRM Cream	
250 lbs.	

NO ASSEMBLY REQUIRED



★ **41572 High Back Executive Chair with Ratchet Back and Adjustable Arms**
 ⚙️
 🌱
Overall Size: 27W x 24.5D x 39.25 - 45.5H
Seat: 20W x 20.5D x 4T **Back:** 18.5W x 24H x 3T **Seat Range:** 18.5 -22
Arms to Floor: 26 **Carton Wt:** 53 **UPS Wt:** 53 **COM:** 1.25 yds
Carton: 26L x 26W x 15H **Cube:** 5.86 **Options:** CG50, SW70
Features: 1, 4, 7, 8, 9 **Control:** 3 Position Locking 2-to-1 Synchro Tilt
Notes: ★ NJ In-Stock: -231

Fabric	List Price
A	365.00
B	385.00
C	415.00
R	460.00



★ **41573 Mid Back Executive Chair with Ratchet Back and Adjustable Arms**
 ⚙️
 🌱
Overall Size: 27W x 24.5D x 35.5 - 41.75H
Seat: 20W x 20.5D x 4T **Back:** 18.5W x 20.5H x 3T **Seat Range:** 18.5 -22
Arms to Floor: 26 **Carton Wt:** 50 **UPS Wt:** 50 **COM:** 1.25 yds
Carton: 26L x 25W x 15H **Cube:** 5.64 **Options:** CG50, SW70
Features: 1, 4, 7, 8, 9 **Control:** 3 Position Locking 2-to-1 Synchro Tilt
Notes: ★ NJ In-Stock: -231

Fabric	List Price
A	338.00
B	355.00
C	382.00
R	425.00



★ **41575 Executive Guest Chair to 41572 and 41573**
 ⚙️
 🌱
Overall Size: 24W x 23D x 36.5H
Seat: 19W x 20.5D x 4T **Back:** 18W x 20H x 3T **Seat Range:** 19.5 Fixed
Arms to Floor: 26.25 **Carton Wt:** 27 **UPS Wt:** 59 **COM:** 1.25 yds
Carton: 36L x 24W x 12H **Cube:** 6.0 **Options:** N/A
Features: N/A **Control:** N/A
Notes: ★ NJ In-Stock: -231

Fabric	List Price
A	225.00
B	238.00
C	255.00
R	285.00



★ **EX2651 Executive Mid Back Manager's Chair with C style Arms**
Overall Size: 26.25W x 27D x 39-43.5H
Seat: 20.5W x 19.25D x 3.5T **Back:** 20.25W x 20.5H x 4.5T **Seat Range:** 19.5 -24.25
Arms to Floor: 27.25 **Carton Wt:** 40 **UPS Wt:** 48 **COM:** 1.75 yds
Carton: 27L x 26W x 14H **Cube:** 5.68 **Options:** CG50, SW70
Features: 1, 4, 5, 8, 9 **Control:** Locking Tilt
Notes: ★ NJ In-Stock: -231

Fabric	Updated List Price
-231 Icon Black	374.00
A	374.00
B	386.00
C	396.00
R	440.00



★ **EX2654 Executive High Back Manager's Chair with C style Arms**
Overall Size: 26W x 27D x 45H
Seat: 21W x 20D x 4T **Back:** 21W x 25H x 4T **Seat Range:** 19.25 -23.5
Arms to Floor: 27.75 **Carton Wt:** 43 **UPS Wt:** 50 **COM:** 1.75 yds
Carton: 30L x 26W x 13H **Cube:** 5.86 **Options:** CG50, SW70
Features: 1, 4, 5, 8, 9 **Control:** Locking Tilt
Notes: ★ NJ In-Stock: -231

Fabric	Updated List Price
-231 Icon Black	384.00
A	395.00
B	418.00
C	440.00
R	466.00



★ **EX2655 Matching Conference/Visitor's Chair to EX2654 and EX2651**
Overall Size: 26W x 27D x 35H
Seat: 21W x 20D x 4T **Back:** 21W x 21H x 4T **Seat Range:** 19 Fixed
Arms to Floor: 27.75 **Carton Wt:** 43 **UPS Wt:** 43 **COM:** 1.75 yds
Carton: 25L x 22W x 15H **Cube:** 4.77 **Options:** N/A
Features: N/A **Control:** N/A
Notes: ★ NJ In-Stock: -231

Fabric	Updated List Price
-231 Icon Black	320.00
A	330.00
B	346.00
C	375.00
R	395.00



★ **BC9601** Guest Chair with soft PU Arms, Sturdy Titanium Metal Frame.

Overall Size: 24.75W x 27.75D x 35H
 Seat: 21.75W x 21D x 3.5T Back: 20.75W x 16H x 3.25T Seat Range: 19.75 Fixed
 Arms to Floor: 27 Carton Wt: 47 UPS Wt: 48 COM: 2.0 yds
 Carton: 36L x 27W x 10H Cube: 5.62 Options: N/A
 Features: N/A Control: N/A
 Notes: ★ NJ In-Stock: -R107

Fabric	List Price
A	405.00
B	420.00
C	440.00
R	475.00
Big & Tall 300 lbs.	



★ **BC9602** Guest Chair with soft PU Arms, Sturdy Titanium Metal Frame.

Overall Size: 28.5W x 27D x 34.5H
 Seat: 25.25W x 20.5D x 3.5T Back: 25.25W x 16H x 2.75T Seat Range: 19.25 Fixed
 Arms to Floor: 26.75 Carton Wt: 52 UPS Wt: 53 COM: 2.5 yds
 Carton: 36L x 27W x 11H Cube: 6.18 Options: N/A
 Features: N/A Control: N/A
 Notes: ★ NJ In-Stock: -R107

Fabric	List Price
A	450.00
B	475.00
C	500.00
R	550.00
Big & Tall 400 lbs.	



★ **BC9603** Guest Chair with soft PU Arms, Sturdy Titanium Metal Frame.

Overall Size: 32.25W x 27D x 34.5H
 Seat: 29W x 20.5D x 3.5T Back: 29W x 16H x 2.75T Seat Range: 19.25 Fixed
 Arms to Floor: 26.75 Carton Wt: 58 UPS Wt: 60 COM: 2.75 yds
 Carton: 36L x 31W x 11H Cube: 7.1 Options: N/A
 Features: N/A Control: N/A
 Notes: ★ NJ In-Stock: -R107

Fabric	List Price
A	505.00
B	550.00
C	600.00
R	675.00
Big & Tall 500 lbs.	

Executive Seating - Big Man's Chairs



★ **EX1098-3M** Executive Big Man's Chair with Mesh Seat and Back, Padded Height Adjustable Arms and Chrome Base. Supports up to 350 lbs.

Overall Size: 27.5W x 28.75D x 45H
 Seat: 21.5W x 19D x 5T Back: 22W x 23.25H x 4.5T Seat Range: 20.75 -24.25
 Arms to Floor: 26.5 Carton Wt: 66 UPS Wt: 66 COM: N/A
 Carton: 31L x 27W x 15H Cube: 7.26 Options: CG50, SW70
 Features: 1, 4, 5, 8, 9 Control: Locking Tilt
 Notes:

Frame/Fabric	Updated List Price
-3M Chrome/ Mesh	558.00
Big & Tall 350 lbs.	



★ **EC1283C-EC3** Executive Bonded Leather Big Man's Chair with Padded Loop Arms and Chrome Base. Supports up to 350 lbs

Overall Size: 27.75W x 31D x 46.5H
 Seat: 23W x 19.5D x 4.5T Back: 22W x 24H x 4.5T Seat Range: 19.75 -23.5
 Arms to Floor: 27.75 Carton Wt: 68 UPS Wt: 68 COM: N/A
 Carton: 34L x 27W x 15H Cube: 7.96 Options: CG50, SW70
 Features: 1, 4, 5, 8, 9 Control: Locking Tilt
 Notes:

Frame/Fabric	Updated List Price
-EC3 Chrome/ Black Bonded Leather	612.00
Big & Tall 350 lbs.	



ECH12801-EC1 Espresso Bonded Leather Big Man's Chair with Coated Padded Loop Arms and Cocoa Metal Base. Supports up to 350 lbs

Overall Size: 28.75W x 29.25D x 46.25H
 Seat: 22.5W x 21.75D x 5.75T Back: 22.25W x 31.5H x 5.75T Seat Range: 19 -22.25
 Arms to Floor: 27.75 Carton Wt: 62 UPS Wt: 66 COM: N/A
 Carton: 32L x 28W x 15H Cube: 7.77 Options: CG50, SW70
 Features: 1, 4, 5, 8, 9 Control: Locking Tilt
 Notes:

Frame/Fabric	Updated List Price
-EC1 Cocoa/ Espresso Bonded Leather	612.00
Big & Tall 350 lbs.	



★ **EC9230** High Back Bonded Leather Executive Chair with Padded Arms

Overall Size: 25W x 29D x 45.25H
 Seat: 20W x 19D x 4T Back: 20.5W x 25.5H x 4T Seat Range: 17.75 -21.5
 Arms to Floor: 27.5 Carton Wt: 37 UPS Wt: 57 COM: N/A
 Carton: 32L x 26W x 14H Cube: 6.74 Options: CG50, SW70
 Features: 1, 4, 5, 8, 9 Control: Locking Tilt
 Notes: **REPLACES** EC1220

Fabric	Updated List Price
Bonded Leather -EC3 Black	372.00



★ **EC9231** Mid Back Bonded Leather Executive Chair with Padded Arms

Overall Size: 24W x 28.75D x 41.5H
 Seat: 20W x 19D x 4T Back: 20W x 21.5H x 4T Seat Range: 17.75 -21.5
 Arms to Floor: 27.5 Carton Wt: 39 UPS Wt: 43 COM: N/A
 Carton: 28L x 24W x 15H Cube: 5.83 Options: CG50, SW70
 Features: 1, 4, 5, 8, 9 Control: Locking Tilt
 Notes: **REPLACES** EC1221

Fabric	Updated List Price
Bonded Leather -EC3 Black	345.00



★ **EC9235** Bonded Leather Visitor's Chair with Padded Arms and Sled Base

Overall Size: 24.5W x 26.5D x 38.25H
 Seat: 20W x 19D x 4T Back: 20W x 21.25H x 4T Seat Range: 18.5 Fixed
 Arms to Floor: 28 Carton Wt: 36 UPS Wt: 45 COM: N/A
 Carton: 28L x 22W x 15H Cube: 5.34 Options: N/A
 Features: N/A Control: N/A
 Notes: **REPLACES** EC1225

Fabric	Updated List Price
Bonded Leather -EC3 Black	320.00



★ **EC6582** Executive High Back Bonded Leather Chair with Two-Tone Stitching

Overall Size: 26.75W x 26.25D x 48.5H
 Seat: 18.75W x 19.75D x 4T Back: 18.75W x 30H x 4.75T Seat Range: 17.25 -20.75
 Arms to Floor: 28.75 Carton Wt: 42 UPS Wt: 55 COM: N/A
 Carton: 31L x 26W x 14H Cube: 6.53 Options: CG50, SW70
 Features: 1, 4, 5, 8, 9 Control: Locking Tilt
 Notes: **Two-Tone Stitching**

Fabric	Updated List Price
Bonded Leather -EC3 Black -EC9 Mocha	372.00



★ **EC6583** Executive High Back Bonded Leather Chair with Color Match Stitching

Overall Size: 26.25W x 28D x 43.5 - 46.5H
 Seat: 20.75W x 20.5D x 3.5T Back: 20W x 26.75H x 3.5T Seat Range: 18.25 -21.25
 Arms to Floor: 27.25 Carton Wt: 40 UPS Wt: 52 COM: N/A
 Carton: 29L x 26W x 14H Cube: 6.1 Options: CG50, SW70
 Features: 1, 4, 5, 8, 9 Control: Locking Tilt
 Notes:

Fabric	Updated List Price
Bonded Leather -EC3 Black -EC4 Burgundy -EC16 Green -EC21 Tan	372.00



★ **EC8124** Bonded Leather Executive Chair with Steel Base and Padded Arms

Overall Size: 25.5W x 27.5D x 34.75H
 Seat: 20.5W x 19D x 4T Back: 20.5W x 17H x 3.5T Seat Range: 19 Fixed
 Arms to Floor: 25.75 Carton Wt: 32 UPS Wt: 46 COM: N/A
 Carton: 27L x 23W x 15H Cube: 5.39 Options: N/A
 Features: N/A Control: N/A
 Notes: Transitioned to Bonded Leather

Fabric	Updated List Price
-EC3 Black -EC4 Burgundy EC21 Tan Bonded Leather	356.00



★ **ECH8967K5-EC1/ECH8967R5-EC3** Executive Bonded Leather Chair, Two-Tone (-EC1) and Matching (-EC3) Stitching with Coated Flip Arms & Coated Nylon Base
Overall Size: 26.75W x 25.5D x 40.75H
Seat: 20W x 19D x 4.5T **Back:** 20W x 20.5H x 4T **Seat Range:** 17.75 -21.75
Arms to Floor: 25.75 **Carton Wt:** 40 **UPS Wt:** 40 **COM:** N/A
Carton: 26L x 23W x 13H **Cube:** 4.49 **Options:** CG50, SW70
Features: 1, 4, 5, 8, 9 **Control:** Locking Tilt
Notes: ECH8967K5-EC1: Two-Tone Stitching. ECH8967R5-EC3: Matching Stitching. No Black End Caps. ★ NJ In-Stock: -EC3

Frame/Fabric	Updated List Price
ECH8967K5-EC1 Cocoa/Espresso	350.00
ECH8967R5-EC3 Silver/Black	



★ **ECH37811-EC1/ECH37816-EC3/ECH37817-EC3** Executive Bonded Leather Chair with Adjustable Coated Flip Arms and Coated Nylon Base
Overall Size: 24.5W x 26.25D x 41.75H
Seat: 20.25W x 19D x 4.4T **Back:** 19W x 20.5H x 3T **Seat Range:** 18-21.75
Arms to Floor: 31.25 **Carton Wt:** 36 **UPS Wt:** 50 **COM:** N/A
Carton: 28L x 26W x 14H **Cube:** 5.89 **Options:** CG50, SW70
Features: 1, 4, 7, 8, 9 **Control:** Locking Tilt
Notes: ★ NJ In-Stock: -ECH37817-EC3

Frame/Fabric	Updated List Price
ECH37811-EC1 Cocoa/Espresso	420.00
ECH37816-EC3 Silver/Black	
ECH37817-EC3 Titanium/Black	



★ **ECH91231-EC1/ECH91236-EC3/ECH91237-EC3** High Back Bonded Leather Executive Manager's Chair with Padded Flip Arms and Coated Nylon Base
Overall Size: 26.75W x 29D x 39.25 - 43H
Seat: 20.5W x 20.5D x 4.5T **Back:** 21.5W x 29.25H x 4.5T **Seat Range:** 18 -21.75
Arms to Floor: 27 **Carton Wt:** 42 **UPS Wt:** 57 **COM:** N/A
Carton: 30L x 26W x 15H **Cube:** 6.77 **Options:** CG50, SW70
Features: 1, 4, 5, 8, 9 **Control:** Locking Tilt
Notes: ★ NJ In-Stock: ECH91236-EC3, ECH91237-EC3

Frame/Fabric	Updated List Price
ECH91231-EC1 Cocoa/Espresso	400.00
ECH91236-EC3 Silver/Black	
ECH91237-EC3 Titanium/Black	



ECH91211-EC1/ECH91216-EC3/ECH91217-EC3 Mid-Back Bonded Leather Executive Manager's Chair with Padded Flip Arms and Coated Nylon Base
Overall Size: 26.75W x 28.5D x 35.5 - 39H
Seat: 20.5W x 20.5D x 4.5T **Back:** 20.5W x 25.25H x 4T **Seat Range:** 18 -21.75
Arms to Floor: 27 **Carton Wt:** 40 **UPS Wt:** 52 **COM:** N/A
Carton: 27L x 26W x 15H **Cube:** 6.09 **Options:** CG50, SW70
Features: 1, 4, 5, 8, 9 **Control:** Locking Tilt
Notes:

Frame/Fabric	Updated List Price
ECH91211-EC1 Cocoa/Espresso	372.00
ECH91216-EC3 Silver/Black	
ECH91217-EC3 Titanium/Black	



ECH75006-EC3/ECH75001-EC1 Executive Bonded Leather Chair with Padded Arms and Wire Cable Control Mechanism
Overall Size: 27.25W x 30D x 44.25-46.5H
Seat: 22W x 22.25D x 6.5T **Back:** 22.5W x 28.25H x 5.25T **Seat Range:** 18.25 -20.5
Arms to Floor: 25.5 **Carton Wt:** 48 **UPS Wt:** 69 **COM:** N/A
Carton: 32L x 26W x 17H **Cube:** 8.1 **Options:** CG50, SW70
Features: 1, 4, 5, 8, 9 **Control:** **Wire Cable**
Notes: Two-Tone Stitching. Coated Nylon Base.
REPLACES ECH30627-EC3 / ECH30621-EC1

Frame/Fabric	Updated List Price
ECH75006-EC3 Silver/Black	525.00
ECH75001-EC1 Cocoa/Espresso	



★ **ECH31826-EC3/ECH31827-EC3/ECH31827-EC6** Bonded Leather Executive Manager's Chair with Padded Arms and Coated Nylon Base
Overall Size: 27W x 30.5D x 47.5H
Seat: 21W x 18.5D x 5T **Back:** 21W x 26.25H x 5T **Seat Range:** 18.25 -22
Arms to Floor: 26.75 **Carton Wt:** 42 **UPS Wt:** 55 **COM:** N/A
Carton: 29L x 26W x 15H **Cube:** 6.54 **Options:** CG50, SW70
Features: 1, 4, 5, 8, 9 **Control:** Locking Tilt
Notes: ★ NJ In-Stock: ECH31826-EC3 & ECH31827-EC3

Frame/Fabric	Updated List Price
ECH31826-EC3 Silver/Black	452.00
ECH31827-EC3 Titanium/Black	
ECH31827-EC6 Titanium/Wine	



- ★ **ECH38615A-EC1/ECH38665A-EC3/ECH38675A-EC3** Executive Bonded Leather Chair with Adjustable Padded Flip Arms and Coated Nylon Base
- Overall Size:** 26W x 30.25D x 47H
Seat: 21.5W x 20D x 4.5T **Back:** 21W x 24.5H x 4.5T **Seat Range:** 18.75 - 23.75
Arms to Floor: 26.5 **Carton Wt:** 40 **UPS Wt:** 54 **COM:** N/A
Carton: 30L x 26W x 14H **Cube:** 6.32 **Options:** CG50, SW70
Features: 1, 4, 5, 8, 9 **Control:** Locking Tilt
Notes: ★ NJ In-Stock: ECH38665A-EC3, ECH38675A-EC3

Frame/Fabric

Updated
List Price

ECH38615A-EC1
Cocoa/Espresso
ECH38665A-EC3
Silver/Black
ECH38675A-EC3
Titanium/Black

525.00



- ECH76506-EC3/ECH76501-EC1** Executive Bonded Leather Chair with Padded Height Adjustable Arms and Wire Cable Control Mechanism
- Overall Size:** 27.75W x 32D x 40.75 - 43.75H
Seat: 22.5W x 20.25D x 5T **Back:** 21.5W x 23H x 4.75T **Seat Range:** 20 - 23
Arms to Floor: 27.25 **Carton Wt:** 51 **UPS Wt:** 65 **COM:** N/A
Carton: 32L x 26W x 16H **Cube:** 7.7 **Options:** CG50, SW70
Features: 1, 4, 5, 8, 9 **Control:** Wire Cable
Notes: Two-Tone Stitching. Coated Nylon Base.
REPLACES ECH52666-EC3 / ECH52661-EC1

Frame/Fabric

Updated
List Price

ECH76506-EC3
Silver/Black

525.00

ECH76501-EC1
Cocoa/Espresso



- ECH70751-EC31/ECH70756-EC3** Executive Bonded Leather Chair with Padded Height Adjustable Arms and Coated Nylon Base
- Overall Size:** 26.5W x 28.25D x 43.25 - 46.25H
Seat: 21.75W x 20D x 5.75T **Back:** 21.75W x 29.25H x 6.75T **Seat Range:** 18.75 - 21.75
Arms to Floor: 26.5 **Carton Wt:** 45 **UPS Wt:** 50 **COM:** N/A
Carton: 26L x 26W x 15H **Cube:** 5.86 **Options:** CG50, SW70
Features: 1, 4, 5, 8, 9 **Control:** Locking Tilt
Notes: Two-Tone Stitching. **Featuring New Flex Back Support.**

Frame/Fabric

Updated
List Price

ECH70751-EC31
Cocoa/Chestnut

490.00

ECH70756-EC3
Silver/Black



- ★ **ECH68801-EC1/ECH68807-EC3** Executive Bonded Leather Chair with Padded Arms and Coated Nylon Base
- Overall Size:** 25.75W x 30D x 47H
Seat: 21W x 20D x 5.25T **Back:** 21W x 25.75H x 5T **Seat Range:** 20 - 22.75
Arms to Floor: 27.75 **Carton Wt:** 49 **UPS Wt:** 61 **COM:** N/A
Carton: 32L x 26W x 15H **Cube:** 7.22 **Options:** CG50, SW70
Features: 1, 4, 5, 8, 9 **Control:** Locking Tilt
Notes:

Frame/Fabric

Updated
List Price

ECH68801-EC1
Cocoa/Espresso

490.00

ECH68807-EC3
Titanium/Black



- ECH70531-EC1/ECH70536-EC3/ECH70537-EC3** Executive Bonded Leather Chair with Adjustable Padded Arms and Coated Nylon Base
- Overall Size:** 26W x 29.5D x 44.5H
Seat: 20.5W x 20D x 4.5T **Back:** 20.5W x 25.75H x 4.75T **Seat Range:** 19.5 - 22.5
Arms to Floor: 26.5 **Carton Wt:** 43 **UPS Wt:** 61 **COM:** N/A
Carton: 30L x 16W x 26H **Cube:** 7.22 **Options:** CG50, SW70
Features: 1, 4, 5, 8, 9 **Control:** Locking Tilt
Notes: Two-Tone Stitching for Cocoa/Espresso and Silver/Black, Matching Stitching for Titanium/Black. Coil Spring Seat.

Frame/Fabric

Updated
List Price

ECH70531-EC1
Cocoa/Espresso
ECH70536-EC3
Silver/Black
ECH70537-EC3
Titanium/Black

480.00



- ★ **ECH83501-EC1/ECH83507-EC3** Executive Bonded Leather Chair with Padded Arms and Coated Nylon Base
- Overall Size:** 25W x 30.5D x 45.5H
Seat: 21.25W x 22D x 5.5T **Back:** 21.25W x 28.5H x 5.75T **Seat Range:** 19 - 22
Arms to Floor: 28 **Carton Wt:** 47 **UPS Wt:** 59 **COM:** N/A
Carton: 29L x 26W x 16H **Cube:** 6.98 **Options:** CG50, SW70
Features: 1, 4, 5, 8, 9 **Control:** Locking Tilt
Notes:

Frame/Fabric

Updated
List Price

ECH83501-EC1
Cocoa/Espresso

480.00

ECH83507-EC3
Titanium/Black



★ **ECH89186-EC3/ECH89187-EC3** Executive Bonded Leather Chair with Coil Spring Seat, Padded Arms and Coated Nylon Base
Overall Size: 28.25W x 30D x 47.25H
Seat: 21W x 19.25D x 4.5T **Back:** 21.25W x 27H x 4.25T **Seat Range:** 18.5 -21.25
Arms to Floor: 26 **Carton Wt:** 51 **UPS Wt:** 63 **COM:** N/A
Carton: 33L x 26W x 15H **Cube:** 7.44 **Options:** CG50, SW70
Features: 1, 4, 5, 8, 9 **Control:** Locking Tilt
Notes: Coil Spring Seat

Frame/Fabric
ECH89186-EC3
 Silver/Black
ECH89187-EC3
 Titanium/Black

Updated List Price
 500.00



★ **ECH89181-EC1/ECH89181-EC6** Executive Bonded Leather Chair with Coil Spring Seat, Padded Arms and Coated Nylon Base
Overall Size: 28.25W x 30D x 47.25H
Seat: 21W x 19.25D x 4.5T **Back:** 21.25W x 27H x 4.25T **Seat Range:** 18.5 -21.25
Arms to Floor: 26 **Carton Wt:** 44 **UPS Wt:** 63 **COM:** N/A
Carton: 33L x 26W x 15H **Cube:** 7.45 **Options:** CG50, SW70
Features: 1, 4, 5, 8, 9 **Control:** Locking Tilt
Notes: Coil Spring Seat.

Frame/Fabric
ECH89181-EC1
 Cocoa/Espresso
ECH89181-EC6
 Cocoa/Wine

Updated List Price
 500.00



ECH89307-EC3/ECH89301-EC1 Executive Bonded Leather Chair with Coil Spring Seat, Padded Arms and Coated Nylon Base
Overall Size: 27.5W x 28.25D x 46.5H
Seat: 20.5W x 19.5D x 5T **Back:** 21W x 28H x 5T **Seat Range:** 17.25 -20.25
Arms to Floor: 28.25 **Carton Wt:** 51 **UPS Wt:** 63 **COM:** N/A
Carton: 33L x 26W x 15H **Cube:** 7.45 **Options:** CG50, SW70
Features: 1, 4, 5, 8, 9 **Control:** Locking Tilt
Notes: Coil Spring Seat

Frame/Fabric
ECH89307-EC3
 Titanium/Black
ECH89301-EC1
 Cocoa/Espresso

Updated List Price
 500.00



OPH61601-EC1/OPH61606-EC3/OPH61607-EC3/OPH61601-EC6 Executive Bonded Leather Chair with PU Padded Height Adjustable Arms & Coated Base
Overall Size: 29 x 26D x 48.5H
Seat: 20.5W x 20D x 5.5T **Back:** 20.5W x 27H x 5T **Seat Range:** 19.75 -22.25
Arms to Floor: 26.5 **Carton Wt:** 60 **UPS Wt:** 78 **COM:** N/A
Carton: 36L x 26W x 17H **Cube:** 9.2 **Options:** CG50, SW70
Features: 1, 4, 5, 6, 8, 9 **Control:** KneeTilt
Notes: Coil Spring Seat.

Frame/Fabric
OPH61601-EC1
 Cocoa/Espresso
OPH61606-EC3
 Silver/Black
OPH61607-EC3
 Titanium/Black
OPH61601-EC6
 Cocoa/Wine

Updated List Price
 635.00



OPH62606-EC3 Executive Bonded Leather Chair with PU Padded Height Adjustable Arms and Coated Base
Overall Size: 29 x 26D x 48.5H
Seat: 20.5W x 19.7D x 5.5T **Back:** 20.5W x 27H x 5T **Seat Range:** 19.75 -22.25
Arms to Floor: 26.5 **Carton Wt:** 56 **UPS Wt:** 78 **COM:** N/A
Carton: 36L x 26W x 17H **Cube:** 9.20 **Options:** CG50, SW70
Features: 1, 4, 5, 6, 8, 9 **Control:** KneeTilt
Notes: Coil Spring Seat

Frame/Fabric
OPH62606-EC3
 Silver/Black

Updated List Price
 635.00

Executive Seating - Leather



★ **EX5161** Deluxe Mid Back Leather Chair with Padded Loop Arms
Overall Size: 26.5W x 31.5D x 42H
Seat: 21.5W x 22D x 5T **Back:** 21.5W x 22.5H x 5T **Seat Range:** 19 -22.5
Arms to Floor: 26.0 **Carton Wt:** 49 **UPS Wt:** 54 **COM:** N/A
Carton: 28L x 26W x 15H **Cube:** 6.31 **Options:** CG50, SW70
Features: 1, 4, 5, 8, 9 **Control:** Locking Tilt
Notes: ★ NJ In-Stock: -G13

Fabric
 Glove Soft Leather
 -G11 Tan
 -G13 Black
 Top Grain Leather
 -4 Burgundy

Updated List Price
 610.00



★ **EX5162** Leather High Back Chair with Padded Loop Arms

Overall Size: 27W x 29.25D x 44 - 48H
Seat: 21.25W x 18.25D x 5.5T **Back:** 21.5W x 25.75H x 6.25T **Seat Range:** 19.5-23
Arms to Floor: 25.75 **Carton Wt:** 56 **UPS Wt:** 72 **COM:** N/A
Carton: 34L x 27W x 16H **Cube:** 8.5 **Options:** CG50, SW70
Features: 1, 4, 5, 8, 9 **Control:** Locking Tilt
Notes:

Fabric Glove Soft Leather	Updated List Price
-G11 Tan -G12 Dark Grey -G13 Black -G16 Green Top Grain Leather -4 Burgundy	660.00

Executive Seating - Faux Leather/Chrome Base



★ **FL1327C** Executive Faux Leather Chair with Padded Arms and Chrome Finish Base

Overall Size: 25W x 27D x 44H
Seat: 20.75W x 19.5D x 1.5T **Back:** 20W x 25H x 2T **Seat Range:** 17.5 - 20.25
Arms to Floor: 26 **Carton Wt:** 48 **UPS Wt:** 48 **COM:** N/A
Carton: 27L x 25W x 14H **Cube:** 5.4 **Options:** CG50, SW70
Features: 1, 4, 5, 8, 9 **Control:** Locking Tilt
Notes: ★ NJ In-Stock: -U6, -U9 and -U11

Fabric	Updated List Price
Faux Leather -U6 Black -U9 Red -U11 White -U28 Cream	478.00



★ **FL27513C** Executive Faux Leather Chair with Built-In Headrest, Padded Flip Arms and Chrome Finish Base

Overall Size: 28.5W x 24.75D x 48H
Seat: 20.75W x 18.5D x 3T **Back:** 20.25W x 28.25H x 3.25T **Seat Range:** 17.25 - 20.25
Arms to Floor: 25.5 **Carton Wt:** 39 **UPS Wt:** 51 **COM:** N/A
Carton: 31L x 26W x 13H **Cube:** 6.06 **Options:** CG50, SW70
Features: 1, 4, 5, 8, 9 **Control:** Locking Tilt
Notes: ★ NJ In-Stock: -U6, -U9 and -U11

Fabric	Updated List Price
Faux Leather -U6 Black -U9 Red -U11 White -U28 Cream	420.00



★ **FL80287C** Faux Leather Chair with Padded Flip Arms and Chrome Finish Base

Overall Size: 24.25W x 26.5D x 38 - 41.5H
Seat: 20W x 18.75D x 3.25T **Back:** 19.5W x 21H x 3T **Seat Range:** 18.5 - 22
Arms to Floor: 26 **Carton Wt:** 40 **UPS Wt:** 40 **COM:** N/A
Carton: 27L x 25W x 12H **Cube:** 4.5 **Options:** CG50, SW70
Features: 1, 4, 5, 8, 9 **Control:** Locking Tilt
Notes: ★ NJ In-Stock: -U6 and -U11

Fabric	Updated List Price
Faux Leather -U6 Black -U11 White -U28 Cream -U42 Charcoal Grey	372.00

NEW



★ **FL90071C** Executive Faux Leather High Back Chair with Padded Arms and Chrome Finish Base

Overall Size: 24.25W x 26.25D x 47.75H
Seat: 18.5W x 19D x 2.75T **Back:** 17.75W x 25.25H x 2.75T **Seat Range:** 20-23
Arms to Floor: 26.5 **Carton Wt:** 42 **UPS Wt:** 50 **COM:** N/A
Carton: 27L x 25W x 15H **Cube:** 7.2 **Options:** CG50, SW70
Features: 1, 4, 5, 8, 9 **Control:** Locking Tilt
Notes: ★ NJ In-Stock: -U6

Fabric	Updated List Price
Faux Leather -U6 Black -U11 White -U28 Cream -U42 Charcoal Grey	478.00



★ **FL92970C** High Back Faux Leather Chair with Padded Arms and Chrome Finish Base

Overall Size: 27.75W x 28.25D x 42.75 - 46.75H
Seat: 20W x 28.75D x 3.5T **Back:** 20W x 25.75H x 3.5T **Seat Range:** 18-22
Arms to Floor: 26 **Carton Wt:** 45 **UPS Wt:** 57 **COM:** N/A
Carton: 32L x 26W x 14H **Cube:** 6.74 **Options:** CG50, SW70
Features: 1, 4, 5, 8, 9 **Control:** Locking Tilt
Notes:

Fabric	Updated List Price
Faux Leather -U6 Black -U11 White -U28 Cream -U42 Charcoal Grey	420.00

NEW

★ NJ In Stock



★ **FL92017C** Mid-Back Faux Leather Chair with Padded Arms and Chrome Finish Base

Overall Size: 23W x 26.75D x 43H
Seat: 19.5W x 22.25D x 2.5T **Back:** 19.25W x 22.25H x 2.5T **Seat Range:** 19 - 22
Arms to Floor: 26.25 **Carton Wt:** 32 **UPS Wt:** 47 **COM:** N/A
Carton: 28L x 26W x 13H **Cube:** 5.4 **Options:** CG50, SW70
Features: 1, 4, 5, 8, 9 **Control:** Locking Tilt
Notes:

Fabric	Updated List Price
Faux Leather -U6 Black -U11 White -U42 Charcoal Grey	345.00



★ **FL92011C** Low-Back Faux Leather Chair with Padded Arms and Chrome Finish Base

Overall Size: 22.25W x 25.5D x 36.25 - 39H
Seat: 19.5W x 19.5D x 3.5T **Back:** 19W x 19H x 3.5T **Seat Range:** 18 - 20.75
Arms to Floor: 26.25 **Carton Wt:** 32 **UPS Wt:** 37 **COM:** N/A
Carton: 24L x 24W x 13H **Cube:** 4.33 **Options:** CG50, SW70
Features: 1, 4, 5, 8, 9 **Control:** Locking Tilt
Notes:

Fabric	Updated List Price
Faux Leather -U6 Black -U11 White -U42 Charcoal Grey	320.00



★ **FL38610C** Low-Back Faux Leather Guest Chair with PP Arms and Chrome Finish Frame

Overall Size: 24.75W x 24.25D x 34H
Seat: 18.25W x 17.25D x 4T **Back:** 18.25W x 14.5H x 3T **Seat Range:** 19.75
Arms to Floor: 27.25 **Carton Wt:** 25 **UPS Wt:** 50 **COM:** N/A
Carton: 33L x 24W x 13H **Cube:** 5.95 **Options:** N/A
Features: N/A **Control:** N/A
Notes:

Fabric	List Price
Faux Leather -U6 Black -U11 White -U42 Charcoal Grey	315.00

NEW



★ **FL38640C** Low-Back Faux Leather Guest Chair with Casters, PP Arms and Chrome Finish Frame

Overall Size: 24.75W x 24.25D x 34H
Seat: 18.25W x 17.25D x 4T **Back:** 18.25W x 14.5H x 3T **Seat Range:** 19.75
Arms to Floor: 27.25 **Carton Wt:** 25 **UPS Wt:** 50 **COM:** N/A
Carton: 33L x 24W x 13H **Cube:** 5.95 **Options:** N/A
Features: N/A **Control:** N/A
Notes: with Casters

Fabric	List Price
Faux Leather -U6 Black -U11 White -U42 Charcoal Grey	330.00

NEW



EC51832MC Mid-Back Bonded Leather Manager's Chair with Chrome Arms and Chrome Finish Base

Overall Size: 24.25W x 25.25D x 37 - 40.5H
Seat: 20W x 18.75D x 3T **Back:** 18.5W x 19.5H x 2.5T **Seat Range:** 18.25 - 21.75
Arms to Floor: 26 **Carton Wt:** 40 **UPS Wt:** 41 **COM:** N/A
Carton: 26L x 25W x 13H **Cube:** 4.89 **Options:** CG50, SW70
Features: 1, 4, 5, 8, 9 **Control:** Locking Tilt
Notes:

Fabric	Updated List Price
Bonded Leather -EC51 Chocolate -EC03 Black	478.00



★ **FL5380C** High Back Executive Faux Leather Chair with Padded Arms and Chrome Finish Base

Overall Size: 23.25W x 26.75D x 45.75-49H
Seat: 19W x 19D x 3.25T **Back:** 18.25W x 26.75H x 3.5T **Seat Range:** 18.75 - 22
Arms to Floor: 27 **Carton Wt:** 45 **UPS Wt:** 86 **COM:** N/A
Carton: 40L x 26W x 17H **Cube:** 10.23 **Options:** CG50, SW70
Features: 1, 4, 5, 8, 9 **Control:** Locking Tilt
Notes:

Fabric	Updated List Price
Faux Leather -U6 Black -U11 White -U22 Smoke -U42 Charcoal Grey	532.00

New Color

★ NJ In Stock



★ **FL5388C** Mid-Back Executive Faux Leather Chair with Padded Arms and Chrome Finish Base

Overall Size: 23.75W x 26D x 38.5 - 42H
 Seat: 19W x 19D x 3.25T Back: 17.5W x 19.5H x 3T Seat Range: 18.5 - 22
 Arms to Floor: 27.25 Carton Wt: 41 UPS Wt: 63 COM: N/A
 Carton: 33L x 26W x 15H Cube: 7.44 Options: CG50, SW70
 Features: 1, 4, 5, 8, 9 Control: Locking Tilt
 Notes:

New Color

Fabric	Updated List Price
Faux Leather -U6 Black -U11 White -U22 Smoke -U42 Charcoal Grey	478.00



★ **FL5385C** Mid-Back Faux Leather Visitor's Chair with Padded Arms and Chrome Finish Base

Overall Size: 24W x 25.5D x 35.75H
 Seat: 19W x 19D x 2T Back: 18W x 18.75H x 2T Seat Range: 18 Fixed
 Arms to Floor: 26.25 Carton Wt: 39 UPS Wt: 70 COM: N/A
 Carton: 25L x 25W x 23H Cube: 8.31 Options: N/A
 Features: N/A Control: N/A
 Notes:

NEW

Fabric	List Price
Faux Leather -U6 Black -U11 White -U22 Smoke -U42 Charcoal Grey	425.00



★ **FL2604C** High Back Executive Faux Leather Chair with Padded Arms and Chrome Base Finish

Overall Size: 25.25W x 28.25D x 43.5H
 Seat: 19.5W x 19.5D x 3.5T Back: 19.5W x 23.5H x 3.5T Seat Range: 18.75-21.75
 Arms to Floor: 27 Carton Wt: 39 UPS Wt: 45 COM: N/A
 Carton: 27L x 26W x 13H Cube: 5.28 Options: CG50, SW70
 Features: 1, 4, 5, 8, 9 Control: Locking Tilt
 Notes:

Fabric	Updated List Price
Faux Leather -U6 Black	395.00

Executive Seating - Faux Leather/Gold Base



FL22991G Mid-Back Faux Leather Chair with Gold Finish Arms and Base

Overall Size: 22.5W x 22D x 36.75-40.25H
 Seat: 18.75W x 17D x 3.25T Back: 18.5W x 18.5H x 3.25T Seat Range: 18.25 - 22.25
 Arms to Floor: 26 Carton Wt: 31 UPS Wt: 34 COM: N/A
 Carton: 24L x 22W x 13H Cube: 3.97 Options: CG50, SW70
 Features: 1, 4, 5, 8, 9 Control: Locking Tilt
 Notes: Featuring Gold Finish Frame

Fabric	Updated List Price
Faux Leather -U5 Navy -U6 Black -U11 White -U28 Cream -U41 Saddle	345.00



FL23591G Mid-Back Faux Leather Chair with Gold Finish Arms and Base

Overall Size: 23.25W x 24.5D x 36.5 - 40.5H
 Seat: 20W x 18.25D x 4.5T Back: 19.5W x 18.25H x 3.5T Seat Range: 18.25 - 22
 Arms to Floor: 25 Carton Wt: 35 UPS Wt: 48 COM: N/A
 Carton: 25L x 24W x 14H Cube: 4.8 Options: CG50, SW70
 Features: 1, 4, 5, 8, 9 Control: Locking Tilt
 Notes: Featuring Gold Finish Frame

Fabric	Updated List Price
Faux Leather -U5 Navy -U6 Black -U28 Cream -U41 Saddle	520.00

Executive Seating - Faux Leather



★ **FL660** Faux Leather Manager's Chair with Padded Arms

Overall Size: 26.5W x 26.25D x 38.25 - 41.25H
 Seat: 21W x 21.75D x 4T Back: 20.5W x 21.75H x 4T Seat Range: 18.75 - 21.75
 Arms to Floor: 26.25 Carton Wt: 38 UPS Wt: 46 COM: N/A
 Carton: 25L x 25W x 15H Cube: 5.42 Options: CG50, SW70
 Features: 1, 4, 5, 8, 9 Control: Locking Tilt
 Notes:

New Color

Fabric	Updated List Price
Faux Leather -U6 Black -U2 Chocolate -U42 Charcoal Grey	265.00

★ NJ In Stock



★ **FL605 Faux Leather Manager's Chair with Padded Arms**

Overall Size: 26W x 26D x 40.5H
 Seat: 20W x 18D x 4T Back: 19.5W x 21H x 4T Seat Range: 18.75 -21.75
 Arms to Floor: 26.5 Carton Wt: 38 UPS Wt: 44 COM: N/A
 Carton: 27L x 24W x 14H Cube: 5.25 Options: CG50, SW70
 Features: 1, 4, 5, 8, 9 Control: Locking Tilt
 Notes: Replaces EC605

Fabric	Updated List Price
Faux Leather -U6 Black -U2 Chocolate -U42 Charcoal Grey New Color	282.00



★ **FL9097 Oversized Faux Leather Executive Chair with Padded Loop Arms**

Overall Size: 26W x 31D x 46H
 Seat: 23W x 21D x 4T Back: 21W x 29H x 5T Seat Range: 18.5 -22
 Arms to Floor: 28 Carton Wt: 42 UPS Wt: 59 COM: N/A
 Carton: 31L x 26W x 15H Cube: 6.99 Options: CG50, SW70
 Features: 1, 4, 5, 8, 9 Control: Locking Tilt
 Notes:

Fabric	Updated List Price
Faux Leather -U6 Black	420.00



★ **FLH24981-U1/FLH24987-U6 Faux Leather Mid Back Manager's Chair with Padded Flip Arms and Coated Base**

Overall Size: 25.75W x 26.5D x 43.25H
 Seat: 20W x 21.75D x 6T Back: 26.75W x 21H x 6.25T Seat Range: 17.5 - 20.5
 Arms to Floor: 27 Carton Wt: 38 UPS Wt: 52 COM: N/A
 Carton: 27L x 26W x 15H Cube: 6.09 Options: CG50, SW70
 Features: 1, 4, 5, 8, 9 Control: Locking Tilt
 Notes:

Fabric	Updated List Price
FLH24981-U1 Cocoa/Esspresso	372.00
FLH24987-U6 Titanium/Black	



★ **FL89675 Faux Leather Manager's Chair with Flip Arms**

Overall Size: 27W x 26D x 42H
 Seat: 20W x 20D x 4T Back: 19.75W x 22H x 4T Seat Range: 17.25 -21
 Arms to Floor: 24.25 Carton Wt: 44 UPS Wt: 38 COM: N/A
 Carton: 26L x 23W x 13H Cube: 4.49 Options: CG50, SW70
 Features: 1, 4, 5, 8, 9 Control: Locking Tilt
 Notes: ★ NJ In-Stock: -U6

Fabric	Updated List Price
Faux Leather -U6 Black -U2 Chocolate -U42 Charcoal Grey New Color	298.00



★ **FL1055 Faux Leather or Fabric Seat and Back Visitor's Chair with Sled Base**

Overall Size: 23W x 23.75D x 34H
 Seat: 20W x 20D x 4T Back: 20W x 14H x 3T Seat Range: 18.5 Fixed
 Arms to Floor: 26.25 Carton Wt: 27 UPS Wt: 34 COM: N/A
 Carton: 33L x 21W x 10H Cube: 4.0 Options: N/A
 Features: N/A Control: N/A
 Notes: **REPLACES EX1055.** ★ NJ In-Stock: -U6

Fabric	Updated List Price
Faux Leather -U6 Black -U1 Espresso	235.00
Fabric -W12 Woven Charcoal -W17 Woven Indigo	



★ **FL1033 Faux Leather or Fabric Visitor's Chair with Sled Base**

Overall Size: 20.5W x 26.5D x 34H
 Seat: 20.5W x 20D x 3T Back: 19.75W x 21.5H x 2T Seat Range: 19 Fixed
 Arms to Floor: N/A Carton Wt: 21 UPS Wt: 26 COM: N/A
 Carton: 32L x 21W x 8H Cube: 3.8 Options: N/A
 Features: N/A Control: N/A
 Notes: ★ NJ In-Stock: -U6

Fabric	Updated List Price
Faux Leather -U6 Black -U1 Espresso	215.00
Fabric -W12 Woven Charcoal -W17 Woven Indigo	

★ NJ In Stock



★ **FL38610** Low-Back Faux Leather Guest Chair with PP Arms and Black Finish Frame
Overall Size: 24.75W x 24.25D x 34H
Seat: 18.25W x 17.25D x 4T **Back:** 18.25W x 14.5H x 3T **Seat Range:** 19.75
Arms to Floor: 27.25 **Carton Wt:** 25 **UPS Wt:** 50 **COM:** N/A
Carton: 33L x 24W x 13H **Cube:** 5.95 **Options:** N/A
Features: N/A **Control:** N/A
Notes:

NEW

Fabric	List Price
Faux Leather -U6 Black -U11 White -U42 Charcoal Grey	300.00



★ **FL38640** Low-Back Faux Leather Guest Chair with Casters, PP Arms and Black Finish Frame
Overall Size: 24.75W x 24.25D x 34H
Seat: 18.25W x 17.25D x 4T **Back:** 18.25W x 14.5H x 3T **Seat Range:** 19.75
Arms to Floor: 27.25 **Carton Wt:** 25 **UPS Wt:** 50 **COM:** N/A
Carton: 33L x 24W x 13H **Cube:** 5.95 **Options:** N/A
Features: N/A **Control:** N/A
Notes: with Casters

NEW

Fabric	List Price
Faux Leather -U6 Black	315.00

Reception Tables



★ **MG1242S-NB** Brooklyn Clear Tempered Glass Top Coffee Table with Nickel Brush Legs
Overall Size: 42W x 24D x 16H
Carton Wt: 40 **UPS Wt:** 40
Carton: 46L x 27W x 5H **Cube:** 3.59
Notes:

Finish	List Price
Nickel Brush and Clear Glass	440.00



★ **MG1230R-NB** Brooklyn Clear Tempered Glass Round Top Coffee Table with Nickel Brush Legs
Overall Size: 30W x 30D x 16H
Carton Wt: 28 **UPS Wt:** 28
Carton: 34L x 33W x 5H **Cube:** 3.24
Notes:

Finish	List Price
Nickel Brush and Clear Glass	440.00



★ **MG0922S-NB** Brooklyn Clear Tempered Glass Square Top End Table with Nickel Brush Legs
Overall Size: 22W x 22D x 20H
Carton Wt: 16 **UPS Wt:** 16
Carton: 26L x 25W x 5H **Cube:** 1.88
Notes:

Finish	List Price
Nickel Brush and Clear Glass	350.00



★ **MG0920R-NB** Brooklyn Clear Tempered Glass Round Top End Table with Nickel Brush Legs
Overall Size: 20W x 20D x 20H
Carton Wt: 14 **UPS Wt:** 14
Carton: 24L x 23W x 5H **Cube:** 1.73
Notes:

Finish	List Price
Nickel Brush and Clear Glass	350.00



★ **WST07/WST07-WH/WST07-BK** Wall Street Foyer/Sofa Table with Chrome Frame and Espresso Finish Wood Top or Black (-BK) or White (-WH) Top
 Overall Size: 36W x 15D x 29H
 Carton Wt: 38 UPS Wt: 42
 Carton: 39L x 31W x 7H Cube: 4.89
 Notes: White table tops are not color-matched to white reception seating
***New Color**

Finish	List Price
Chrome/Espresso Chrome/White (-WH) Chrome/Black (-BK)	500.00



★ **WST09/WST09-WH/WST09-BK** Wall Street End Table with Chrome Frame and Espresso Finish Wood Top or Black (-BK) or White (-WH) Top
 Overall Size: 22W x 15.75D x 18.5H
 Carton Wt: 13 UPS Wt: 13
 Carton: 25L x 20W x 5H Cube: 1.45
 Notes: White table tops are not color-matched to white reception seating
***New Color**

Finish	List Price
Chrome/Espresso Chrome/White (-WH) Chrome/Black (-BK)	215.00



★ **WST12/WST12-WH/WST12-BK** Wall Street Coffee Table with Chrome Frame and Espresso Finish Wood Top or Black (-BK) or White (-WH) Top
 Overall Size: 44W x 22D x 15H
 Carton Wt: 31 UPS Wt: 31
 Carton: 48L x 26W x 5H Cube: 3.61
 Notes: White table tops are not color-matched to white reception seating
***New Color**

Finish	List Price
Chrome/Espresso Chrome/White (-WH) Chrome/Black (-BK)	325.00



★ **WST17/WST17-WH/WST17-BK** Wall Street 28" Accent/Corner Table with Chrome Frame and Espresso Finish Wood Top or Black (-BK) or White (-WH) Top
 Overall Size: 28W x 28D x 17H
 Carton Wt: 30 UPS Wt: 30
 Carton: 32L x 30W x 5H Cube: 2.78
 Notes: White table tops are not color-matched to white reception seating
***New Color**

Finish	List Price
Chrome/Espresso Chrome/White (-WH) Chrome/Black (-BK)	370.00



★ **WST16-ESP/WST16-WH/WST16-BK** Wall Street Multi-Purpose Side Table with Chrome Frame and Espresso Finish Wood Top or Black (-BK) or White (-WH) Top
 Overall Size: 16W x 16D x 24.25H
 Carton Wt: 18 UPS Wt: 41
 Carton: 26L x 18W x 18H Cube: 4.87
 Notes: White table tops are not color-matched to white reception seating

Finish	List Price
Chrome/Espresso (-ESP) Chrome/White (-WH) Chrome/Black (-BK)	280.00



★ **YLD07** Yield Foyer/Sofa Table with Chrome Frame and Black Glass Top
 Overall Size: 36W x 15D x 29H
 Carton Wt: 37 UPS Wt: 37
 Carton: 39L x 32W x 6H Cube: 4.33
 Notes:

Finish	List Price
Chrome and Black Glass	370.00

	★ YLD09 Yield End Table with Chrome Frame and Black Glass Top	Finish	List Price
	⚙️ Overall Size: 22W x 15.75D x 18.5H	Chrome and Black Glass	180.00
	Carton Wt: 16 UPS Wt: 16 Carton: 26L x 21W x 5H Cube: 1.58		
	Notes:		

	★ YLD17 Yield 28" Accent/Corner Table with Chrome Frame and Black Glass Top	Finish	List Price
	⚙️ Overall Size: 28W x 28D x 17H	Chrome and Black Glass	265.00
	Carton Wt: 35 UPS Wt: 35 Carton: 32L x 30W x 5H Cube: 2.78		
	Notes:		

	★ YLD12 Yield Coffee Table with Chrome Frame and Black Glass Top	Finish	List Price
	⚙️ Overall Size: 44W x 22D x 15H	Chrome and Black Glass	265.00
	Carton Wt: 28 UPS Wt: 28 Carton: 48L x 23W x 5H Cube: 3.19		
	Notes:		

Reception Seating

	★ WST51A Wall Street Arm Chair with Chrome Base	Fabric	Updated List Price
	⚙️ Overall Size: 30.5W x 28D x 31H Seat: 23W x 22D Back: 23W x 16H Seat Range: 17.5 Fixed Arms to Floor: 26 Carton Wt: 70 UPS Wt: 95 COM: N/A Carton: 31L x 26W x 24H Cube: 11.19 Options: N/A Features: N/A Control: N/A Notes: Stand Alone.	Faux Leather -B18 Black -E34 Espresso -W32 White -U22 Smoke	595.00

	★ WST51LF Left Arm Facing Wall Street Modular Component with Chrome Base	Fabric	Updated List Price
	⚙️ Overall Size: 27W x 28D x 31H Seat: 23W x 22D Back: 23W x 16H Seat Range: 17.5 Fixed Arms to Floor: 26 Carton Wt: 55 UPS Wt: 79 COM: N/A Carton: 29L x 25W x 22H Cube: 9.24 Options: N/A Features: N/A Control: N/A Notes: Use as Part of Sofa, Loveseat or Sectional	Faux Leather -B18 Black -E34 Espresso -W32 White -U22 Smoke	535.00

	★ WST51N Armless Wall Street Modular Component with Chrome Base	Fabric	Updated List Price
	⚙️ Overall Size: 23W x 28D x 31H Seat: 23W x 22D Back: 23W x 16H Seat Range: 17.5 Fixed Arms to Floor: N/A Carton Wt: 39 UPS Wt: 58 COM: N/A Carton: 26L x 25W x 18H Cube: 6.77 Options: N/A Features: N/A Control: N/A Notes: Use as Stand Alone or Part of Sofa, Loveseat or Sectional.	Faux Leather -B18 Black -E34 Espresso -W32 White -U22 Smoke	455.00

Wall Street Chair Collection



★ **WST51RF** Right Arm Facing Wall Street Modular Component with Chrome Base
 ✪
Overall Size: 27W x 28D x 31H
Seat: 23W x 22D **Back:** 23W x 16H **Seat Range:** 17.5 Fixed
Arms to Floor: 26 **Carton Wt:** 55 **UPS Wt:** 79 **COM:** N/A
Carton: 29L x 24W x 23H **Cube:** 9.26 **Options:** N/A
Features: N/A **Control:** N/A
Notes: Use as Part of Sofa, Loveseat or Sectional

Fabric	Updated List Price
Faux Leather -B18 Black -E34 Espresso -W32 White -U22 Smoke	535.00



★ **WST51C** Corner Wall Street Modular Component with Chrome Base
 ✪
Overall Size: 28W x 28D x 31H
Seat: 23W x 22D **Back:** 23W x 16H **Seat Range:** 17.5 Fixed
Arms to Floor: N/A **Carton Wt:** 54 **UPS Wt:** 92 **COM:** N/A
Carton: 29L x 26W x 25H **Cube:** 10.91 **Options:** N/A
Features: N/A **Control:** N/A
Notes: Use as Part of Corner Sectional

Fabric	Updated List Price
Faux Leather -B18 Black -E34 Espresso -W32 White -U22 Smoke	595.00



★ **WST51P** Center Wall Street Modular Component, Chrome Base with AC and USB 3.0 Charging Station.
 ✪
Overall Size: 6.5W x 28.25D x 20H
Carton Wt: 19 **UPS Wt:** 21 **COM:** N/A
Carton: 29L x 21W x 7H **Cube:** 2.38 **Options:** N/A
Features: N/A **Control:** N/A
Notes: UL Certified.

Fabric	Updated List Price
Faux Leather -B18 Black -E34 Espresso -W32 White -U22 Smoke	332.00



★ **WST51OP** Ottoman Wall Street Modular Component, Chrome Base with AC and USB 3.0 Charging Station.
 ✪
Overall Size: 29.25W x 24D x 17.25H
Seat: 29.25W x 24D x 6T **Seat Range:** 17.25 Fixed
Arms to Floor: N/A **Carton Wt:** 33 **UPS Wt:** 44 **COM:** N/A
Carton: 30L x 25W x 12H **Cube:** 5.20 **Options:** N/A
Features: N/A **Control:** N/A
Notes: UL Certified.

Fabric	Updated List Price
Faux Leather -B18 Black -E34 Espresso -W32 White -U22 Smoke	558.00



★ **ATH51** Anthony 26" Wide Chair with Chrome Base

Overall Size: 26W x 33D x 32.5H
 Seat: 26W x 22D x 5.5T Back: 26W x 15H x 5.5T Seat Range: 18.5 Fixed
 Arms to Floor: N/A Carton Wt: 39 UPS Wt: 110 COM: N/A
 Carton: 32L x 27W x 26H Cube: 13 Options: N/A
 Features: N/A Control: N/A
 Notes: UPSable, Oversized Package. ★ -B18 Only Available in NJ

Fabric	Updated List Price
-B18 Black PU -W32 White PU	560.00



ATH52 Anthony 57.5" Wide Loveseat with Chrome Base

Overall Size: 58W x 32.75D x 32.5H
 Seat: 57.5W x 22D x 5.5T Back: 57.5W x 15H x 5.5T Seat Range: 18.5 Fixed
 Arms to Floor: N/A Carton Wt: 76 UPS Wt: No UPS COM: N/A
 Carton: 58L x 32W x 26H Cube: 27.9 Options: N/A
 Features: N/A Control: N/A
 Notes:

Fabric	Updated List Price
-B18 Black PU -W32 White PU	950.00



ATH51CG Anthony 26" Wide Chair with Gold Base

Overall Size: 26W x 33D x 32.5H
 Seat: 26W x 22D x 5.5T Back: 26W x 15H x 5.5T Seat Range: 18.5 Fixed
 Arms to Floor: N/A Carton Wt: 40 UPS Wt: 110 COM: N/A
 Carton: 32L x 27W x 26H Cube: 13 Options: N/A
 Features: N/A Control: N/A
 Notes: UPSable, Oversized Package.

Fabric	Updated List Price
-B18 Black PU -W32 White PU	560.00



ATH52CG Anthony 57.5" Wide Loveseat with Gold Base

Overall Size: 57.5W x 33D x 32.5H
 Seat: 57.5W x 22D x 5.5T Back: 57.5W x 15H x 5.5T Seat Range: 18.5 Fixed
 Arms to Floor: N/A Carton Wt: 76 UPS Wt: No UPS COM: N/A
 Carton: 58L x 32W x 26H Cube: 27.9 Options: N/A
 Features: N/A Control: N/A
 Notes:

Fabric	Updated List Price
-B18 Black PU -W32 White PU	950.00



LS481C Guest Chair with Chrome Base

Overall Size: 29.75W x 30D x 40.75H
 Seat: 18.75W x 17.75D x 5.75T Back: 22W x 23H x 5T Seat Range: 18.25 Fixed
 Arms to Floor: 22.75 Weight: 44 UPS Weight: 114 COM: N/A
 Carton: 39L x 30W x 20H Cube: 13.54 Options: N/A
 Features: 1, 4 Control: N/A
 Notes:

Fabric	List Price
-U6 Black -U11 White -K14 Klein Azure -K26 Klein Charcoal	625.00

NEW



★ **YLD5130** Yield 31" Wide Chair with Chrome Base

Overall Size: 30.5W x 26.75D x 31H
 Seat: 16W x 19.5D x 3.75T Back: 26W x 23H x 4T Seat Range: 16.5 Fixed
 Arms to Floor: 20.5 Carton Wt: 43 UPS Wt: 123 COM: N/A
 Carton: 32L x 28W x 28H Cube: 14.51 Options: N/A
 Features: N/A Control: N/A
 Notes: UPSable, Oversized Package.

Fabric	Updated List Price
Faux Leather -B18 Black -W32 White	525.00



★ YLD5141 Yield 40" Wide Chair with Chrome Base



Overall Size: 38.5W x 30.5D x 30.5H
 Seat: 24W x 22.5D x 3.75 Back: 31.5W x 13.75H x 4T Seat Range: 16.5 Fixed
 Arms to Floor: 20.5 Carton Wt: 51 UPS Wt: 152 COM: N/A
 Carton: 40L x 31W x 25H Cube: 17.94 Options: N/A
 Features: N/A Control: N/A
 Notes: UPSable, Oversized Package

Fabric	Updated List Price
Faux Leather -B18 Black -W32 White	625.00



NVA51 Nova 31.5" Wide Chair with Foam-Filled Back and Seat Cushions, Protective Floor Glides and Four-Star Chrome Base

Overall Size: 31W x 30D x 33H
 Seat: 21.25W x 18.25D x 3.75T Back: 19.75W x 14.75H x 5T Seat Range: 18.75 Fixed
 Arms to Floor: 24.5 Carton Wt: 52 UPS Wt: 125 COM: N/A
 Carton: 33L x 31W x 25H Cube: 14.8 Options: N/A
 Features: 4 Control: N/A
 Notes: UPSable, Oversized Package

Fabric	Updated List Price
Faux Leather -B18 Black -W32 White -U9 Red	620.00



★ PAC51 Pacific Arm Chair in Fabric with Chrome Finish Legs

Overall Size: 32W x 30.5D x 29.5H
 Seat: 23W x 22D x 5T Back: 23.5W x 12.25H x 4.75T Seat Range: 17.5 Fixed
 Arms to Floor: 24.5 Carton Wt: 49 UPS Wt: 102 COM: 6 yds.
 Carton: 30L x 29W x 24H Cube: 12.08 Options: N/A
 Features: N/A Control: N/A
 Notes: UPSable, Oversized Package.
 ★ NJ In-Stock: -M19 and -M59

For additional Custom Fabrics, please see page 35. **New Colors**

Fabric	Updated List Price
-M5 Tangerine -M17 Green -M19 Navy -M52 Cream -M59 Cement	525.00



★ PAC52 Pacific Loveseat in Fabric with Chrome Finish Legs

Overall Size: 51.5W x 30.5D x 29.5H
 Seat: 42W x 22D x 5T Back: 42W x 12.25H x 4.75T Seat Range: 17.5 Fixed
 Arms to Floor: 24.5 Carton Wt: 67 UPS Wt: 143 COM: 10 yds.
 Carton: 43L x 31W x 22H Cube: 16.97 Options: N/A
 Features: N/A Control: N/A
 Notes: UPSable, Oversized Package.
 ★ NJ In-Stock: -M19 and -M59

For additional Custom Fabrics, please see page 35. **New Colors**

Fabric	Updated List Price
-M5 Tangerine -M17 Green -M19 Navy -M52 Cream -M59 Cement	720.00



★ PAC53 Pacific Sofa in Fabric with Chrome Finish Legs

Overall Size: 72.5W x 30.5D x 29.5H
 Seat: 63.5W x 22D x 5T Back: 63.5W x 12.25H Seat Range: 17.5 Fixed
 Arms to Floor: 24.5 Carton Wt: 90 UPS Wt: No UPS COM: 14 yds.
 Carton: 64L x 31W x 22H Cube: 25.25 Options: N/A
 Features: N/A Control: N/A

Notes: Non-UPSable. ★ NJ In-Stock: -M19 and -M59

For additional Custom Fabrics, please see page 35. **New Colors**

Fabric	Updated List Price
-M17 Green -M19 Navy -M59 Cement	955.00



★ PAC51 Pacific Arm Chair with Chrome Finish Legs

Overall Size: 32W x 30.5D x 29.5H
 Seat: 23W x 22D x 5T Back: 23.5W x 12.25H x 4.75T Seat Range: 17.5 Fixed
 Arms to Floor: 24.5 Carton Wt: 49 UPS Wt: 102 COM: 6 yds.
 Carton: 30L x 29W x 24H Cube: 12.08 Options: N/A
 Features: N/A Control: N/A
 Notes: UPSable, Oversized Package. Also available in Dillon Fabrics.
 ★ NJ In-Stock: -V18 Black and Dillon Fabrics

For additional Custom Fabrics, please see page 35.

Fabric	Updated List Price
-V18 Vinyl Black -V34 Vinyl Espresso	495.00
-R101 Dillon Snow -R105 Dillon Blue -R107 Dillon Black	575.00

	<p>★ PAC52 Pacific Loveseat with Chrome Finish Legs</p> <p>Overall Size: 51.5W x 30.5D x 29.5H Seat: 42W x 22D x 5T Back: 42W x 12.25H x 4.75T Seat Range: 17.5 Fixed Arms to Floor: 24.5 Carton Wt: 67 UPS Wt: 143 COM: 10 yds. Carton: 43L x 31W x 22H Cube: 16.97 Options: N/A Features: N/A Control: N/A Notes: UPSable, Oversized Package. Also available in Dillon Fabrics. ★ NJ In-Stock: -V18 Black and Dillon Fabrics For additional Custom Fabrics, please see page 35.</p>	<p>Fabric</p> <p>-V18 Vinyl Black -V34 Vinyl Espresso</p>	<p>Updated List Price</p> <p>675.00</p>
	<p>-R101 Dillon Snow -R105 Dillon Blue -R107 Dillon Black</p>	<p>800.00</p>	

	<p>★ PAC53 Pacific Sofa with Chrome Finish Legs</p> <p>Overall Size: 72.5W x 30.5D x 29.5H Seat: 63.5W x 22D x 5T Back: 63.5W x 12.25H x 4.75T Seat Range: 17.5 Fixed Arms to Floor: 24.5 Carton Wt: 90 UPS Wt: No UPS COM: 14 yds. Carton: 64L x 31W x 22H Cube: 25.25 Options: N/A Features: N/A Control: N/A Notes: Non-UPSable. Also available in Dillon Fabrics. ★ NJ In-Stock: -V18 Black and Dillon Fabrics For additional Custom Fabrics, please see page 35.</p>	<p>Fabric</p> <p>-V18 Vinyl Black -V34 Vinyl Espresso</p>	<p>Updated List Price</p> <p>900.00</p>
	<p>-R101 Dillon Snow -R105 Dillon Blue -R107 Dillon Black</p>	<p>1125.00</p>	

	<p>★ ATL51 Atlantic Arm Chair in Dillon Fabric with a Single UL Approved AC and USB 3.0 Charging Station, Chrome Finish Legs</p> <p>Overall Size: 32W x 30.5D x 29.5H Seat: 23W x 22D x 5T Back: 23.5W x 12.25H x 4.75T Seat Range: 18 Fixed Arms to Floor: 24.5 Carton Wt: 53 UPS Wt: 100 COM: 6 yds. Carton: 30L x 29W x 24H Cube: 12.08 Options: N/A Features: N/A Control: N/A Notes: UPSable, Oversized Package. Single Power Unit. UL Certified. For additional Custom Fabrics, please see page 36.</p>	<p>Fabric</p> <p>-R101 Dillon Snow -R105 Dillon Blue -R107 Dillon Black</p>	<p>Updated List Price</p> <p>670.00</p>
-----------------------------------------------------------------------------------	-----------------------------------------------------------------------------------------------------------------------------------------------------------------------------------------------------------------------------------------------------------------------------------------------------------------------------------------------------------------------------------------------------------------------------------------------------------------------------------------------------------------------------------------------------------------------------------------------------------------------------------------------------------	---------------------------------------------------------------------------------------------------------------------------------------------------------------------------------------------	------------------------------------------------

	<p>★ ATL52 Atlantic Loveseat in Dillon Fabric with Dual UL Approved AC and USB 3.0 Charging Station, Chrome Finish Legs</p> <p>Overall Size: 51.5W x 30.5D x 29.5H Seat: 42W x 22D x 5T Back: 42W x 12.25H x 4.75T Seat Range: 17.5 Fixed Arms to Floor: 24.5 Carton Wt: 68 UPS Wt: 143 COM: 10 yds. Carton: 43L x 31W x 22H Cube: 16.97 Options: N/A Features: N/A Control: N/A Notes: UPSable, Oversized Package. Dual Power Unit. UL Certified. For additional Custom Fabrics, please see page 36.</p>	<p>Fabric</p> <p>-R101 Dillon Snow -R105 Dillon Blue -R107 Dillon Black</p>	<p>Updated List Price</p> <p>955.00</p>
-------------------------------------------------------------------------------------	-------------------------------------------------------------------------------------------------------------------------------------------------------------------------------------------------------------------------------------------------------------------------------------------------------------------------------------------------------------------------------------------------------------------------------------------------------------------------------------------------------------------------------------------------------------------------------------------------------------------------------------------------------	---------------------------------------------------------------------------------------------------------------------------------------------------------------------------------------------	------------------------------------------------

	<p>★ ATL53 Atlantic Sofa in Dillon Fabric with Dual UL Approved AC and USB 3.0 Charging Station, Chrome Finish Legs</p> <p>Overall Size: 72.5W x 30.5D x 29.5H Seat: 63.5W x 22D x 5T Back: 63.5W x 12.25H x 4.75T Seat Range: 17.5 Fixed Arms to Floor: 24.5 Carton Wt: 90 UPS Wt: No UPS COM: 14 yds. Carton: 64L x 31W x 22H Cube: 25.25 Options: N/A Features: N/A Control: N/A Notes: Non-UPSable. Dual Power Unit. UL Certified. For additional Custom Fabrics, please see page 36.</p>	<p>Fabric</p> <p>-R101 Dillon Snow -R105 Dillon Blue -R107 Dillon Black</p>	<p>Updated List Price</p> <p>1340.00</p>
-------------------------------------------------------------------------------------	-------------------------------------------------------------------------------------------------------------------------------------------------------------------------------------------------------------------------------------------------------------------------------------------------------------------------------------------------------------------------------------------------------------------------------------------------------------------------------------------------------------------------------------------------------------------------------------------------------------------------------------------	---------------------------------------------------------------------------------------------------------------------------------------------------------------------------------------------	-------------------------------------------------

Reception Seating - Wood

	<p>WD483 Accent Chair with Coffee Finish Wood Legs</p> <p>Overall Size: 28.75W x 25.75D x 31H Seat: 20W x 20.25D x 6.25T Back: 23W x 12.5H x 3.75T Seat Range: 18.25 Fixed Arms to Floor: 22.75 Weight: 29 UPS Weight: 77 COM: N/A Carton: 29L x 27W x 20H Cube: 9.06 Options: N/A Features: N/A Control: N/A Notes:</p>	<p>Fabric</p> <p>Coffee Finish with -M24 Milford Dove -M25 Milford Toast -M48 Milford Asphalt</p>	<p>Updated List Price</p> <p>495.00</p>
	<p style="text-align: right;">NEW</p>		

★ NJ In Stock



VVN Vivian Accent Chair with Espresso Finish Wood Legs

Overall Size: 25W x 23D x 32H
Seat: 20W x 20.5D **Back:** 17.5W x 12.25H **Seat Range:** N/A
Arms to Floor: N/A **Weight:** 28 **UPS Weight:** 60 **COM:** N/A
Carton: 26L x 25W x 19H **Cube:** 7.14 **Options:** N/A
Features: N/A **Control:** N/A
Notes:

Fabric

Espresso Finish With
 -L32 Linen
 -V14 Azure Velvet
 -V17 Otter Velvet

Updated List Price

410.00



MST55 Main Street Guest Chair with Espresso Finish Wood Legs

Overall Size: 24.25W x 26.5D x 34.5H
Seat: 18.25W x 22.5D **Back:** 24.25W x 15.25H **Seat Range:** 19.25 Fixed
Arms to Floor: 24.5 **Weight:** 29 **UPS Weight:** 83 **COM:** N/A
Carton: 26L x 26W x 25H **Cube:** 9.78 **Options:** N/A
Features: N/A **Control:** N/A
Notes:

Fabric

Espresso Finish With
 -S22 Woven Seaweed
 -C28 Woven Wheat
 -W11 Woven Chocolate
 -W12 Woven Charcoal
 -W17 Woven Indigo

Updated List Price

312.00



ETN Ethan Accent Chair with Espresso Finish Wood Legs

Overall Size: 30W x 26D x 29H
Seat: 21W x 19.5D **Back:** 29.75W x 11.75H **Seat Range:** 18.5 Fixed
Arms to Floor: N/A **Weight:** 35 **UPS Weight:** 95 **COM:** N/A
Carton: 30L x 27W x 24H **Cube:** 11.25 **Options:** N/A
Features: N/A **Control:** N/A
Notes:

Fabric

Espresso Finish With
 -L37 Blue Denim
 -L38 Linen
 -PD22 Cranberry
 -PD24 Cocoa
 -PD26 Pewter

Updated List Price

420.00



CPR51 Couper Accent Chair with Coffee Finish Wood Legs

Overall Size: 29W x 29.25D x 32H
Seat: 18W x 19D x 5T **Back:** 18W x 20H x 4T **Seat Range:** 18.75 Fixed
Arms to Floor: N/A **Weight:** 38 **UPS Weight:** 101 **COM:** N/A
Carton: 31L x 29W x 23H **Cube:** 11.96 **Options:** N/A
Features: N/A **Control:** N/A
Notes:

Fabric

Coffee Finish With
 -M55 Dove
 -M19 Navy
 -M18 Taupe
 -M17 Green

Updated List Price

420.00

NEW



MAE Mattie Accent Chair with Coffee Finish Wood Legs

Overall Size: 28.75W x 27.75D x 36H
Seat: 19.25W x 18D x 6.25T **Back:** 24.75W x 17.25H x 4T **Seat Range:** 18.5 Fixed
Arms to Floor: 24.75 **Weight:** 34 **UPS Weight:** 103 **COM:** N/A
Carton: 29L x 29W x 25H **Cube:** 12.16 **Options:** N/A
Features: N/A **Control:** N/A
Notes:

Fabric

Coffee Finish With
 -M5 Tangerine
 -M17 Green
 -M19 Navy

List Price

595.00

NEW



SHE Shelly Tufted Chair with Coffee Finish Wood Legs

Overall Size: 28W x 31.5D x 33.5H
Seat: 28.25W x 20.75D x 1T **Back:** 23.25W x 16.5H x 3T **Seat Range:** 17 Fixed
Arms to Floor: N/A **Weight:** 31 **UPS Weight:** 101 **COM:** N/A
Carton: 31L x 29W x 23H **Cube:** 11.96 **Options:** N/A
Features: N/A **Control:** N/A
Notes:

Fabric

Coffee Finish With
 -K14 Azure
 -K21 Sea
 -K26 Charcoal
 -L32 Linen

Updated List Price

420.00

NEW



CHA51 Chatou Accent Chair with Coffee Finish Wood Legs

Overall Size: 28W x 31D x 34.25H
Seat: 18.5W x 21D x 7.5T **Back:** 24W x 15.5H x 5T **Seat Range:** 19 Fixed
Arms to Floor: 24 **Weight:** 37 **UPS Weight:** 109 **COM:** N/A
Carton: 31L x 28W x 24H **Cube:** 12.05 **Options:** N/A
Features: N/A **Control:** N/A
Notes:

NEW

Fabric	Updated List Price
Coffee Finish With -V36 Emerald Green -V37 Charcoal -V38 Midnight Blue	500.00



RHD51 Rhodes Accent Chair with Coffee Finish Wood Legs

Overall Size: 26.75W x 31D x 32.75H
Seat: 20W x 21D x 9.25T **Back:** 23W x 13.5H x 5T **Seat Range:** 19 Fixed
Arms to Floor: N/A **Weight:** 34 **UPS Weight:** 106 **COM:** N/A
Carton: 31L x 28W x 25H **Cube:** 12.5 **Options:** N/A
Features: N/A **Control:** N/A
Notes:

NEW

Fabric	Updated List Price
Coffee Finish With -M17 Green -M21 Blue -M55 Dove	452.00



MST51 Main Street Chair with Espresso Finish Wood Accents

Overall Size: 30W x 29.5D x 32H
Seat: 23.75W x 23D **Back:** 24.5W x 17H **Seat Range:** 18 Fixed
Arms to Floor: 25.25 **Carton Wt:** 56 **UPS Wt:** 89 **COM:** 5 yds.
Carton: 29L x 25W x 25H **Cube:** 10.49 **Options:** N/A
Features: N/A **Control:** N/A
Notes: Weight Capacity Limit: 265 lbs.
 Also available in Custom Fabric, see page 37.

Fabric	Updated List Price
Espresso Finish w/ Ave Six Fabric -C28 Woven Wheat -S22 Woven Seaweed -W12 Woven Charcoal -W17 Woven Indigo	585.00



MST52 Main Street Loveseat with Espresso Finish Wood Accents

Overall Size: 49.25W x 29.5D x 32H
Seat: 43.5W x 22.5D **Back:** 44.5W x 17H **Seat Range:** 18 Fixed
Arms to Floor: 25.25 **Carton Wt:** 86 **UPS Wt:** 150 **COM:** 6 yds.
Carton: 46L x 29W x 23H **Cube:** 17.77 **Options:** N/A
Features: N/A **Control:** N/A
Notes: Weight Capacity Limit: 529 lbs.
 Also available in Custom Fabric, see page 37.

Fabric	Updated List Price
Espresso Finish w/ Ave Six Fabric -C28 Woven Wheat -S22 Woven Seaweed -W12 Woven Charcoal -W17 Woven Indigo	815.00



MST53 Main Street Sofa with Espresso Finish Wood Accents

Overall Size: 75W x 30.75D x 32.75H
Seat: 69W x 21.5D **Back:** 69W x 27H **Seat Range:** 18.25 Fixed
Arms to Floor: 26 **Carton Wt:** 111 **UPS Wt:** No UPS **COM:** 7.5 yds.
Carton: 69L x 29W x 22H **Cube:** 25.47 **Options:** N/A
Features: N/A **Control:** N/A
Notes: Weight Capacity Limit: 650 lbs.
 Also available in Custom Fabric, see page 37.

Fabric	Updated List Price
Espresso Finish w/ Ave Six Fabric -C28 Woven Wheat -S22 Woven Seaweed -W12 Woven Charcoal -W17 Woven Indigo	1120.00



DVS51 28.5" Wide Fabric Armchair with Solid Wood Frame

Overall Size: 26.5W x 28.5D x 32.25H
Seat: 24.25W x 19.5D x 4T **Back:** 23.5W x 17H x 3.5T **Seat Range:** 17.25 Fixed
Arms to Floor: 22.5 **Carton Wt:** 31 **UPS Wt:** 55 **COM:** 1.5 yds.
Carton: 28L x 25W x 16H **Cube:** 6.48 **Options:** N/A
Features: N/A **Control:** N/A
Notes:

Fabric	Updated List Price
-K12 Klein Otter -K14 Klein Azure -K21 Klein Sea -K26 Klein Charcoal -L32 Linen	450.00
A	502.00
B	528.00
C	556.00
R	618.00



DVS52 Fabric Loveseat with Solid Wood Frame



Overall Size: 52W x 29D x 32H
Seat: 48.75W x 19.5D x 3.5T **Back:** 48.75W x 17H x 3.5T **Seat Range:** 16.5 Fixed
Arms to Floor: 22.25 **Carton Wt:** 53 **UPS Wt:** 96 **COM:** 5 yds.
Carton: 52L x 25W x 15H **Cube:** 11.28 **Options:** N/A
Features: N/A **Control:** N/A
Notes: UPSable, Oversized Package.



Fabric
 -K12 Klein Otter
 -K14 Klein Azure
 -K21 Klein Sea
 -K26 Klein Charcoal
 -L32 Linen

Updated List Price

735.00
 A 805.00
 B 850.00
 C 900.00
 R 985.00

WDN51 28.5" Wide Fabric Armchair with Solid Wood Frame



Overall Size: 27.25W x 29.25D x 32.25H
Seat: 24W x 20D x 5.5T **Back:** 23.5W x 23H x 5T **Seat Range:** 17 Fixed
Arms to Floor: 21.25 **Carton Wt:** 34 **UPS Wt:** 55 **COM:** 1.5 yds.
Carton: 28L x 25W x 16H **Cube:** 6.48 **Options:** N/A
Features: N/A **Control:** N/A
Notes:

NEW

Fabric
 -K14 Klein Azure
 -K21 Klein Sea
 -K26 Klein Charcoal
 -L32 Linen

List Price

450.00

Reception Seating - Wood Modular



WD380 Medium Oak Finish Visitor's Chair



Overall Size: 23W x 26D x 34H
Seat: 21W x 18D x 4T **Back:** 20W x 17.5H x 3T **Seat Range:** 18 Fixed
Arms to Floor: 26.75 **Carton Wt:** 27 **UPS W:** 36 **COM:** 1.75
Carton: 28L x 22W x 12H **Cube:** 4.27 **Options:** N/A
Features: N/A **Control:** N/A
Notes: No Tools Required for Assembly. No Add-On Kit.

Fabric
 -K103 Herb, -K100
 Luna, -363 Black
 Triangle or -U6
 Black Faux Leather

Updated List Price

315.00
 A 335.00
 B 355.00
 C 375.00
 R 395.00



★ **WD383 Mahogany Finish Visitor's Chair**

Overall Size: 22.5W x 24.75D x 32.75H
Seat: 20.25W x 18D x 4.5T **Back:** 20.25W x 15.25H x 4T **Seat Range:** 17.75 Fixed
Arms to Floor: 26.5 **Carton Wt:** 22 **UPS Wt:** 33 **COM:** 1.75
Carton: 28L x 22W x 11H **Cube:** 3.92 **Options:** N/A
Features: N/A **Control:** N/A
Notes: No Tools Required for Assembly.
 ★ NJ In-Stock: -363 Black Triangle, -K114 Ruby & -U

Fabric	Updated List Price
-K114 Ruby, -K102 Ash, -363 Black Triangle or -U6 Black Faux Leather	315.00
A	335.00
B	355.00
C	375.00
R	395.00



★ **WA383 Mahogany Finish Modular Single Add-On Kit**

Overall Size: Adds 21.5" to Overall Width
Seat: 20.25W x 18D x 4.5T **Back:** 20.25W x 15.25H x 4T **Seat Range:** 17.75 Fixed
Arms to Floor: 26.5 **Carton Wt:** 20 **UPS Wt:** 33 **COM:** 1.75
Carton: 28L x 22W x 11H **Cube:** 3.92 **Options:** N/A
Features: N/A **Control:** N/A
Notes: Extends Single to Double, Triple or More. Must Use with WD383
 ★ NJ In-Stock: -363 Black Triangle, -K114 Ruby & -U6 Black

Fabric	Updated List Price
-K114 Ruby, -K102 Ash, -363 Black Triangle or -U6 Black Faux Leather	245.00
A	260.00
B	275.00
C	290.00
R	305.00



★ **WD387 Cherry Finish Visitor's Chair**

Overall Size: 23W x 26D x 34H
Seat: 21W x 18D x 4T **Back:** 20W x 17.5H x 3T **Seat Range:** 18 Fixed
Arms to Floor: 26.75 **Carton Wt:** 27 **UPS Wt:** 36 **COM:** 1.75
Carton: 28L x 22W x 12H **Cube:** 4.27 **Options:** N/A
Features: N/A **Control:** N/A
Notes: No Tools Required for Assembly.
 ★ NJ In-Stock: -363 Black Triangle, -K113 Indigo & -U6

Fabric	Updated List Price
-K113 Indigo, -K100 Luna, -K102 Ash, -363 Black Triangle or -U6 Blk Faux Leather	315.00
A	335.00
B	355.00
C	375.00
R	395.00



★ **WA387 Cherry Finish Modular Single Add-On Kit**

Overall Size: Adds 21.5" to Overall Width
Seat: 21W x 18D x 4T **Back:** 20W x 17.5H x 3T **Seat Range:** 18 Fixed
Arms to Floor: 26.75 **Carton Wt:** 22 **UPS Wt:** 33 **COM:** 1.75
Carton: 28L x 22W x 11H **Cube:** 3.92 **Options:** N/A
Features: N/A **Control:** N/A
Notes: Extends Single to Double, Triple or More. Must Use with WD387
 ★ NJ In-Stock: -363 Black Triangle, -K113 Indigo & -U6 Black

Fabric	Updated List Price
-K113 Indigo, -K100 Luna, -K102 Ash, -363 Black Triangle or -U6 Blk Faux Leather	245.00
A	260.00
B	275.00
C	290.00
R	305.00



★ **WD388 Espresso Finish Visitor's Chair**

Overall Size: 23W x 25.5D x 33.5H
Seat: 21W x 18D x 4T **Back:** 20W x 17.5H x 3T **Seat Range:** 18 Fixed
Arms to Floor: 26.75 **Carton Wt:** 27 **UPS Wt:** 36 **COM:** 1.75
Carton: 28L x 22W x 12H **Cube:** 4.27 **Options:** N/A
Features: N/A **Control:** N/A
Notes: No Tools Required for Assembly.
 ★ NJ In-Stock: -363 Black Triangle, -K102 Ash & -U6 Black

Fabric	Updated List Price
-K100 Luna, -K102 Ash, -363 Black Triangle or -U6 Black Faux Leather	315.00
A	335.00
B	355.00
C	375.00
R	395.00



★ **WA388 Espresso Finish Modular Single Add-On Kit**

Overall Size: Adds 21.5" to Overall Width
Seat: 21W x 18D x 4T **Back:** 20W x 17.5H x 3T **Seat Range:** 18 Fixed
Arms to Floor: 26.75 **Carton Wt:** 20 **UPS Wt:** 30 **COM:** 1.75
Carton: 28L x 22W x 10H **Cube:** 3.56 **Options:** N/A
Features: N/A **Control:** N/A
Notes: Extends Single to Double, Triple or More. Must Use with WD388
 ★ NJ In-Stock: -363 Black Triangle, -K102 Ash & -U6 Black

Fabric	Updated List Price
-K100 Luna, -K102 Ash, -363 Black Triangle or -U6 Black Faux Leather	245.00
A	260.00
B	275.00
C	290.00
R	305.00

★ NJ In Stock



-K102 Ash

-K114 Ruby

-K100 Luna

-K113 Indigo



WD1353 Deluxe Mahogany Finish Guest Chair

Overall Size: 24W x 25D x 35.5H
Seat: 21W x 18D x 4T **Back:** 20W x 17.5H x 3T **Seat Range:** 18.75 Fixed
Arms to Floor: 26.75 **Carton Wt:** 28 **UPS Wt:** 51 **COM:** 2.0 yds
Carton: 28L x 25W x 15H **Cube:** 6.07 **Options:** N/A
Features: N/A **Control:** N/A
Notes: No Tools Required for Assembly.

Fabric -K113 Indigo or -K102 Ash	Updated List Price 370.00
A	390.00
B	410.00
C	432.00
R	455.00



WD1357 Deluxe Cherry Finish Guest Chair

Overall Size: 23.75W x 25D x 35.5H
Seat: 21W x 18.5D x 5.5T **Back:** 20.75W x 17H x 3.25T **Seat Range:** 19 Fixed
Arms to Floor: 26.75 **Carton Wt:** 29 **UPS Wt:** 48 **COM:** 2.0 yds
Carton: 27L x 24W x 15H **Cube:** 5.62 **Options:** N/A
Features: N/A **Control:** N/A
Notes: No Tools Required for Assembly.

Fabric -K100 Luna or -K102 Ash	Updated List Price 370.00
A	390.00
B	410.00
C	432.00
R	455.00



WD1358 Deluxe Espresso Finish Guest Chair

Overall Size: 24W x 25D x 35.5H
Seat: 21W x 18D x 4T **Back:** 20W x 17.5H x 3T **Seat Range:** 18.75 Fixed
Arms to Floor: 26.75 **Carton Wt:** 27 **UPS Wt:** 48 **COM:** 2.0 yds
Carton: 27L x 24W x 15H **Cube:** 5.62 **Options:** N/A
Features: N/A **Control:** N/A
Notes: No Tools Required for Assembly.

Fabric -K113 Indigo, -K114 Ruby, -K102 Ash or -363 Black Triangle	Updated List Price 370.00
A	390.00
B	410.00
C	432.00
R	455.00

Reception Tables - Wood



★ **MRG09 Merge 20" Round End Table in solid wood and wood veneers.**

Overall Size: 20W x 20D x 22H
Carton Wt: 30 **UPS Wt:** 30
Carton: 24L x 24W x 8H **Cube:** 2.67

Notes: CHY and MAH Colors compliment Napa Casegoods

Finish -ESP Espresso -BK Black -CHY Cherry -MAH Mahogany	Updated List Price 292.00
-----------------------------------------------------------------------------	-------------------------------------



★ **MRG12 Merge 36" Round Coffee Table in solid wood and wood veneers.**

Overall Size: 36W x 36D x 18H
Carton Wt: 57 **UPS Wt:** 57
Carton: 40L x 39W x 5H **Cube:** 4.51

Notes: CHY and MAH Colors Compliment Napa Casegoods

Finish -ESP Espresso -BK Black -CHY Cherry -MAH Mahogany	Updated List Price 532.00
-----------------------------------------------------------------------------	-------------------------------------

★ NJ In Stock



Finishes



-BK
Black



-CHY
Cherry



-ESP
Espresso



-MAH
Mahogany

**Merge Table
Collection**

★ **MRG12SR1** Merge 30" Square Coffee Table in solid wood and wood veneers.

Overall Size: 30.25W x 30.25D x 18.25H

Carton Wt: 46 UPS Wt: 46

Carton: 33L x 33W x 6H Cube: 3.78

Notes: CHY and MAH Colors Compliment Napa Casegoods



Finish	Updated List Price
-ESP Espresso -BK Black -CHY Cherry -MAH Mahogany	505.00

★ **MRG09S** Merge 20" Square End Table in solid wood and wood veneers.

Overall Size: 20W x 20D x 20.75H

Carton Wt: 33 UPS Wt: 33

Carton: 23L x 23W x 8H Cube: 2.44

Notes: CHY and MAH Colors Compliment Napa Casegoods



Finish	Updated List Price
-ESP Espresso -BK Black -CHY Cherry -MAH Mahogany	308.00

★ **MRG07R1** Merge Foyer Table in solid wood and wood veneers.

Overall Size: 36W x 15D x 30.25H

Carton Wt: 45 UPS Wt: 45

Carton: 39L x 18W x 7H Cube: 2.84

Notes: CHY and MAH Colors Compliment Napa Casegoods



Finish	Updated List Price
-ESP Espresso -BK Black -CHY Cherry -MAH Mahogany	420.00

★ **MRG12R** Merge Rectangular Cocktail Table in solid wood and wood veneers.

Overall Size: 42.25W x 24D x 19H

Carton Wt: 36 UPS Wt: 36

Carton: 45L x 27W x 6H Cube: 4.22

Notes: CHY and MAH Colors Compliment Napa Casegoods



Finish	Updated List Price
-ESP Espresso -BK Black -CHY Cherry -MAH Mahogany	548.00

Traditional Executive Seating - Vinyl

★ **TEX220** Deluxe High Back Traditional Executive Chair

Overall Size: 29W x 30D x 46H

Seat: 18.75W x 19.5D x 4T Back: 19.25W x 24H x 4T Seat Range: 21.25 -24

Arms to Floor: 26.75 Carton Wt: 67 UPS Wt: 88 COM: N/A

Carton: 29L x 27W x 23H Cube: 10.42 Options: N/A

Features: 1, 4, 5, 8, 9 Control: Locking Tilt

Notes:



Fabric	Updated List Price
-JT4 Jamestown Vinyl w/Mahogany Finish Base	665.00

★ NJ In Stock



★ **TEX228** Deluxe High Back Traditional Executive Chair

Overall Size: 27.5W x 32D x 49.5H
Seat: 18.5W x 20D x 4T **Back:** 20.5W x 27.25H x 4.5T **Seat Range:** 20.5 -23
Arms to Floor: 25.25 **Carton Wt:** 66 **UPS Wt:** 8 **COM:** N/A
Carton: 29L x 27W x 23H **Cube:** 10.42 **Options:** N/A
Features: 1, 4, 5, 8, 9 **Control:** Locking Tilt
Notes: ★ NJ In-Stock: -3 and -JT4

Fabric
 -JT4 Jamestown
 Vinyl w/Mahogany
 Finish Base

**Updated
List Price**
 665.00



★ **TEX232** Traditional Executive Chair with Padded Arms

Overall Size: 28.5W x 26.5D x 51.75H
Seat: 24W x 19D x 4.5T **Back:** 21.75W x 28H x 4T **Seat Range:** 20 -24.75
Arms to Floor: 29.25 **Carton Wt:** 55 **UPS Wt:** 71 **COM:** N/A
Carton: 35L x 26W x 16H **Cube:** 8.42 **Options:** N/A
Features: 1, 4, 5, 8, 9 **Control:** Locking Tilt
Notes: ★ NJ In-Stock: -3 and -JT4

Fabric
 -JT4 Jamestown
 Vinyl w/Mahogany
 Finish Frame

**Updated
List Price**
 532.00



★ **TEX234** Traditional Queen Ann Style Chair

Overall Size: 29W x 32D x 39.5H
Seat: 18.75W x 19D x 4T **Back:** 19.25W x 23.25H x 4T **Seat Range:** 17.5 Fixed
Arms to Floor: 23.25 **Carton Wt:** 49 **UPS Wt:** 75 **COM:** N/A
Carton: 30L x 27W x 19H **Cube:** 8.9 **Options:** N/A
Features: N/A **Control:** N/A
Notes:

Fabric
 -JT4 Jamestown
 Vinyl w/Mahogany
 Finish Legs

**Updated
List Price**
 610.00

Traditional Reception Seating - Vinyl



★ **TV230** Traditional Guest Chair with Wrap Around Back and Mahogany Finish Frame

Overall Size: 25.25W x 24D x 30.75H
Seat: 24.25W x 21.25D x 4T **Back:** 23W x 7H x 3.5T **Seat Range:** 18.75 Fixed
Arms to Floor: 25 **Carton Wt:** 27 **UPS Wt:** 32 **COM:** N/A
Carton: 28L x 26W x 9H **Cube:** 3.79 **Options:** N/A
Features: N/A **Control:** N/A
Notes: ★ NJ In-Stock: **TV230-3** Black Vinyl

Fabric
 -JT4 Jamestown
 Vinyl w/Mahogany
 Finish Frame

-3 Black Vinyl
 w/Mahogany
 Finish Frame

**Updated
List Price**
 230.00



★ **TV231** Traditional Guest Chair with Wrap Around Back, Casters and Mahogany Finish Frame

Overall Size: 25.25W x 23.5D x 30.25H
Seat: 23.5W x 20.25D x 6T **Back:** 23.75W x 11.75H x 4T **Seat Range:** 18 Fixed
Arms to Floor: 24.5 **Carton Wt:** 25 **UPS Wt:** 31 **COM:** N/A
Carton: 27L x 26W x 9H **Cube:** 3.65 **Options:** N/A
Features: N/A **Control:** N/A
Notes: ★ NJ In-Stock: **TV231-3** Black Vinyl

Fabric
 -JT4 Jamestown
 Vinyl w/Mahogany
 Finish Frame

-3 Black Vinyl
 w/Mahogany
 Finish Frame

**Updated
List Price**
 240.00



★ **TV233** Traditional Guest Chair with Padded Arms and Mahogany Finish Frame

Overall Size: 27W x 24.5D x 34H
Seat: 22.5W x 17.5D x 3.5T **Back:** 22W x 17H x 3.5T **Seat Range:** 18.5 Fixed
Arms to Floor: 25 **Carton Wt:** 24 **UPS Wt:** 37 **COM:** N/A
Carton: 34L x 22W x 10H **Cube:** 4.32 **Options:** N/A
Features: N/A **Control:** N/A
Notes: ★ NJ In-Stock: -3 and -JT4

Fabric
 -JT4 Jamestown
 Vinyl w/Mahogany
 Finish Frame

**Updated
List Price**
 345.00

★ NJ In Stock

	<p>★ TSX1121 Queen Ann Traditional Jamestown Vinyl Chair with Mahogany Finish Legs</p> <p>Overall Size: 29.75W x 27.25D x 32.25H Seat: 19W x 20.25D Back: 19W x 17H Seat Range: 20 Fixed Arms to Floor: 27.5 Carton Wt: 61 UPS Wt: No UPS COM: N/A Carton: 31L x 30W x 26H Cube: 13.99 Options: N/A Features: N/A Control: N/A Notes: NON-UPSABLE</p>	<p>Fabric</p> <p>-JT4 Jamestown Vinyl w/Mahogany Finish Legs</p>	<p>Updated List Price</p> <p>775.00</p>
-----------------------------------------------------------------------------------	------------------------------------------------------------------------------------------------------------------------------------------------------------------------------------------------------------------------------------------------------------------------------------------------------------------------------------------------------------------------------------------------------------------------------------------------------------------------------	-------------------------------------------------------------------------	------------------------------------------------

	<p>★ TSX1122 Queen Ann Traditional Jamestown Vinyl Loveseat with Mahogany Finish Legs</p> <p>Overall Size: 48.5W x 27.25D x 33H Seat: 28.5W x 20D Back: 38.5W x 18H Seat Range: 20 Fixed Arms to Floor: 27.5 Carton Wt: 78 UPS Wt: No UPS COM: N/A Carton: 51L x 30W x 26H Cube: 23.02 Options: N/A Features: N/A Control: N/A Notes: NON-UPSABLE</p>	<p>Fabric</p> <p>-JT4 Jamestown Vinyl with Mahogany Finish Frame</p>	<p>Updated List Price</p> <p>985.00</p>
-----------------------------------------------------------------------------------	------------------------------------------------------------------------------------------------------------------------------------------------------------------------------------------------------------------------------------------------------------------------------------------------------------------------------------------------------------------------------------------------------------------------------------------------------------------------------	-----------------------------------------------------------------------------	------------------------------------------------

	<p>★ TSX1123 Queen Ann Traditional Jamestown Vinyl Sofa with Mahogany Finish Legs</p> <p>Overall Size: 65.5W x 27.25D x 34H Seat: 54.5W x 20.25D Back: 54.5W x 19H Seat Range: 20 Fixed Arms to Floor: 27.5 Carton Wt: 105 UPS Wt: No UPS COM: N/A Carton: 67L x 31W x 27H Cube: 32.45 Options: N/A Features: N/A Control: N/A Notes: NON-UPSABLE</p>	<p>Fabric</p> <p>-JT4 Jamestown Vinyl with Mahogany Finish Frame</p>	<p>Updated List Price</p> <p>1330.00</p>
-----------------------------------------------------------------------------------	------------------------------------------------------------------------------------------------------------------------------------------------------------------------------------------------------------------------------------------------------------------------------------------------------------------------------------------------------------------------------------------------------------------------------------------------------------------------------	-----------------------------------------------------------------------------	-------------------------------------------------

	<p>★ TBB4020 Mahogany Finish Queen Ann Traditional Coffee Table</p> <p>Overall Size: 40W x 20D x 16H</p> <p>Carton Wt: 28 UPS Wt: 28 Carton: 41L x 21W x 5H Cube: 2.49</p> <p>Notes:</p>	<p>Finish</p> <p>Mahogany</p>	<p>Updated List Price</p> <p>480.00</p>
-------------------------------------------------------------------------------------	----------------------------------------------------------------------------------------------------------------------------------------------------------------------------------------------------------------------	--------------------------------------	------------------------------------------------

	<p>★ TBB2020 Mahogany Finish Queen Ann Traditional End Table</p> <p>Overall Size: 20W x 20D x 20H</p> <p>Carton Wt: 17 UPS Wt: 17 Carton: 21L x 21W x 4H Cube: 1.02</p> <p>Notes:</p>	<p>Finish</p> <p>Mahogany</p>	<p>Updated List Price</p> <p>335.00</p>
-------------------------------------------------------------------------------------	-------------------------------------------------------------------------------------------------------------------------------------------------------------------------------------------------------------------	--------------------------------------	------------------------------------------------

Drafting Chairs

	<p>⚙️ ST215 Backless Stool with Nylon Base and Dual Wheel Carpet Casters</p> <p>Overall Size: 26W x 26D x 26.5H Seat: 13.5W x 13.5D x 2.75T Back: N/A Seat Range: 17.25 - 24.5 Arms to Floor: N/A Carton Wt: 17 UPS Wt: 21 COM: N/A Carton: 23L x 23W x 8H Cube: 2.45 Options: CG50, SW70 Features: 1, 4 Control: Pneumatic Height Notes:</p>	<p>Fabric</p> <p>Black Vinyl</p>	<p>List Price</p> <p>110.00</p>
-------------------------------------------------------------------------------------	---------------------------------------------------------------------------------------------------------------------------------------------------------------------------------------------------------------------------------------------------------------------------------------------------------------------------------------------------------------------------------------------------------------------------------------------------------------	-----------------------------------------	----------------------------------------

★ NJ In Stock



⚙️ **ST217** Backless Stool with Dual Wheel Carpet Casters, Nylon Base and Adjustable Foot Ring
 🌿
Overall Size: 26W x 26D x 33H
Seat: 13.5W x 13.5D x 2.75T **Back:** N/A **Seat Range:** 23 - 33
Arms to Floor: N/A **Carton Wt:** 23 **UPS Wt:** 28 **COM:** N/A
Carton: 25L x 25W x 9H **Cube:** 3.26 **Options:** CG50, SW70
Features: 1, 4 **Control:** Pneumatic Height
Notes:

Fabric	List Price
Black Vinyl	165.00



⚙️ **ST203** Backless Stool with Saddle Seat, Dual Wheel Carpet Casters, Nylon Base and Seat Angle Adjustment
 🌿
Overall Size: 22.5W x 22.5D x 19.5 - 24.25H
Seat: 16W x 11D x 1.5T **Back:** N/A **Seat Range:** 18.25 - 23
Arms to Floor: N/A **Carton Wt:** 23 **UPS Wt:** 23 **COM:** N/A
Carton: 24L x 24W x 8H **Cube:** 2.66 **Options:** CG50, SW70
Features: 1, 4, 5, 9 **Control:** Pneumatic Height w/Adjustable Seat Angle
Notes:

Fabric	List Price
Black Vinyl	250.00
Dillon	270.00



⚙️ **ST205** Backless Stool with Saddle Seat, Dual Wheel Carpet Casters, Nylon Base, Adjustable Foot Ring and Seat Angle Adjustment
 🌿
Overall Size: 26W x 22.5D x 25.75-36.5H
Seat: 16W x 11D x 1.5T **Back:** N/A **Seat Range:** 24.5-34.25
Arms to Floor: N/A **Carton Wt:** 26 **UPS Wt:** 31 **COM:** N/A
Carton: 24L x 24W x 11H **Cube:** 3.66 **Options:** CG50, SW70
Features: 1, 4, 5, 9 **Control:** Pneumatic Height w/Adjustable Seat Angle
Notes:

Fabric	List Price
Black Vinyl	295.00
Dillon	315.00

Dillon (antimicrobial)

Attractive antimicrobial PVC free polyurethane available in 8 eye-catching finishes, and is engineered to meet 200,000 double rubs and CAL117 flammability requirements.

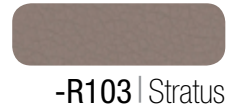
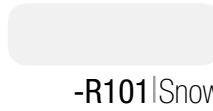

⚙️ **DC430** Ergonomic Molded Foam Seat and Back Drafting Chair with Chrome Teardrop Footrest and Dual Wheel Carpet Casters
 🌿
Overall Size: 22.5W x 25D x 49.5H
Seat: 18W x 17.25D x 3T **Back:** 16.5W x 11.25H x 2.5T **Seat Range:** 23 - 33
Arms to Floor: N/A **Carton Wt:** 33 **UPS Wt:** 34 **COM:** 0.8 yds
Carton: 24L x 24W x 12H **Cube:** 4.0 **Options:** CG50, SW70
Features: 1, 2, 3, 4 **Control:** Pneumatic Height
Notes: Teardrop Footrest is not Adjustable

Fabric	List Price
-231 Icon Black	225.00
A	220.00
B	232.00
C	250.00
R	270.00



★ **DC517** Ergonomic Molded Foam Seat and Back Drafting Chair with Adjustable Footring and Dual Wheel Carpet Casters

⚙️
🌿

Overall Size: 19.5W x 23.5D x 49.5H
Seat: 18W x 17D x 2.5T **Back:** 16W x 10.5H x 2T **Seat Range:** 23 - 33
Arms to Floor: N/A **Carton Wt:** 33 **UPS Wt:** 33 **COM:** 0.8 yds
Carton: 24L x 23W x 12H **Cube:** 3.83 **Options:** CG50, SW70
Features: 1, 2, 3, 4 **Control:** Pneumatic Height
Notes: ★ NJ In-Stock: -231

Fabric	List Price
A	220.00
B	232.00
C	250.00
R	270.00



★ **DC517V** Ergonomic Vinyl Drafting Chair in Molded Foam Seat and Back with Adjustable Footring and Dual Wheel Carpet Casters

⚙️
🌿

Overall Size: 19.5W x 23.5D x 49.5H
Seat: 18W x 17D x 2.5T **Back:** 16W x 10.5H x 2T **Seat Range:** 23 - 33
Arms to Floor: N/A **Carton Wt:** 33 **UPS Wt:** 33 **COM:** 0.8 yds
Carton: 24L x 23W x 12H **Cube:** 3.83 **Options:** CG50, SW70
Features: 1, 2, 3, 4 **Control:** Pneumatic Height
Notes:

Fabric	List Price
Black Vinyl	230.00
Dillon	250.00



⚙️
🌿 **DC550** Sculptured Seat and Back Drafting Chair with Adjustable Footring and Dual Wheel Carpet Casters

Overall Size: 19.5W x 25D x 50-52H
Seat: 19.5W x 19D x 4T **Back:** 18W x 16.5H x 3.5T **Seat Range:** 24 - 34.25
Arms to Floor: N/A **Carton Wt:** 36 **UPS Wt:** 37 **COM:** 0.8 yds
Carton: 24L x 24W x 13H **Cube:** 4.33 **Options:** CG50, SW70
Features: 1, 2,3, 4 **Control:** Pneumatic Height
Notes:

Fabric	List Price
A	350.00
B	368.00
C	395.00
R	440.00



★ **DC630** Drafting Chair with Stool Kit and Dual Wheel Carpet Casters

⚙️
🌿

Overall Size: 20W x 23.25D x 47.5H
Seat: 18.5W x 18.25D x 3T **Back:** 17W x 15.5H x 3T **Seat Range:** 24.75 - 29.75
Arms to Floor: N/A **Carton Wt:** 32 **UPS Wt:** 32 **COM:** 0.8 yds
Carton: 24L x 24W x 10H **Cube:** 3.33 **Options:** 07, CG50, SW70
Features: 1, 2, 3, 4 **Control:** Pneumatic Height
Notes: Stool Kit add 7.5 inches of height. ★ NJ In-Stock: -231

Fabric	List Price
A	285.00
B	300.00
C	322.00
R	360.00



★ **DC640** Intermediate Height Lumbar Support Drafting Chair with Adjustable Footring and Dual Wheel Carpet Casters

⚙️
🌿

Overall Size: 20W x 23D x 44.5H
Seat: 18.5W x 18.25D x 2.5T **Back:** 17W x 15H x 2T **Seat Range:** 19.75 - 27.25
Arms to Floor: N/A **Carton Wt:** 32 **UPS Wt:** 34 **COM:** 0.8 yds
Carton: 24L x 24W x 12H **Cube:** 4.0 **Options:** 07, CG50, SW70
Features: 1, 2, 3, 4 **Control:** Pneumatic Height
Notes: ★ NJ In-Stock: -231

Fabric	List Price
A	310.00
B	325.00
C	350.00
R	390.00



⚙️
🌿 **DC800** Contemporary Drafting Chair with Flex Back and 20 Inch Diameter Adjustable Footring and Dual Wheel Carpet Casters

Overall Size: 21.25W x 24.75D x 52H
Seat: 19.5W x 19D x 3T **Back:** 17W x 16H x 2.5T **Seat Range:** 24 - 34
Arms to Floor: N/A **Carton Wt:** 36 **UPS Wt:** 40 **COM:** 0.8 yds
Carton: 24L x 24W x 14H **Cube:** 4.66 **Options:** CG50, SW70
Features: 1, 2, 3, 4, 12 **Control:** Pneumatic Height with Flex Back
Notes:

Fabric	List Price
A	380.00
B	400.00
C	430.00
R	475.00



★ **DC940** Deluxe Ergonomic Drafting Chair w/18.5 inch Diameter Adjustable Footring, Seat and Back Angle Adjustment and Dual Wheel Carpet Casters

Overall Size: 19W x 25D x 46H
 Seat: 18.5W x 17.75D x 3.25T Back: 17.75W x 16.75H x 2.75T Seat Range: 17 - 26.5
 Arms to Floor: N/A Carton Wt: 38 UPS Wt: 40 COM: 0.8 yds
 Carton: 24L x 24W x 14H Cube: 4.66 Options: 07, CG50, SW70
 Features: 1, 2, 4, 10 Control: Multi Task
 Notes: ★ NJ In-Stock: -231

Fabric	List Price
A	400.00
B	420.00
C	450.00
R	500.00



★ **DC2990** Deluxe Mesh Back Drafting Chair with 18 inch Diameter Adjustable Footring, Black Icon Fabric Seat and Dual Wheel Carpet Casters

Overall Size: 18W x 18.5D x 41-51.75H
 Seat: 18.5W x 18.25D x 2.75T Back: 17.5W x 15.75H Seat Range: 25 - 34.75
 Arms to Floor: N/A Carton Wt: 32 UPS Wt: 40 COM: N/A
 Carton: 26L x 26W x 12H Cube: 4.69 Options: CG50, SW70, 07-ARMS-3
 Features: 1, 3, 4 Control: Pneumatic Height
 Notes:

Fabric	List Price
Black Icon	310.00



★ **DC2990V** Deluxe Mesh Back Drafting Chair with 18.5 inch Diameter Adjustable Footring, Black Vinyl Seat and Dual Wheel Carpet Casters

Overall Size: 18W x 18.5D x 41-51.75H
 Seat: 18.5W x 18.25D x 2.75T Back: 17.5W x 15.75H Seat Range: 25 - 34.75
 Arms to Floor: N/A Carton Wt: 32 UPS Wt: 40 COM: N/A
 Carton: 26L x 26W x 12H Cube: 4.69 Options: CG50, SW70, 07-ARMS-3
 Features: 1, 3, 4 Control: Pneumatic Height
 Notes:

Fabric	List Price
Black Vinyl Seat	310.00
Dillon	320.00



DC51000N Deluxe Woven Mesh Back Armless Drafting Chair in Fabric Seat w/Adjustable Footring & Dual Wheel Carpet Casters

Overall Size: 19.5W x 22D x 40.5 - 47.75H
 Seat: 18.5W x 24D x 2.25T Back: 18W x 19.75H Seat Range: 21 - 28.25
 Arms to Floor: N/A Carton Wt: 31 UPS Wt: 38 COM: 0.5 yds
 Carton: 26L x 25W x 12H Cube: 4.51 Options: CG50, SW70
 Features: 1, 4 Control: Pneumatic Height
 Notes:

Fabric	Updated List Price
-231 Icon Black	372.00
A	400.00
B	425.00
C	460.00
R	485.00



DC51000NV Deluxe Woven Mesh Back Armless Drafting Chair in Vinyl Seat w/Adjustable Footring & Dual Wheel Carpet Casters

Overall Size: 19.5W x 22D x 40.5 - 47.75H
 Seat: 18.5W x 24D x 2.25T Back: 18W x 19.75H Seat Range: 21 - 28.25
 Arms to Floor: N/A Carton Wt: 30 UPS Wt: 41 COM: 0.5 yds
 Carton: 26L x 25W x 13H Cube: 4.89 Options: CG50, SW70
 Features: 1, 4 Control: Pneumatic Height
 Notes:

Fabric	Updated List Price
-3 Black Vinyl	372.00



★ **DCY69200PC** Screen Back Armless Drafting Chair in Black Fabric Seat with Adjustable Footring and Dual Wheel Carpet Casters

Overall Size: 22W x 22.5D x 40.75-47.75H
 Seat: 18.75W x 18D x 2.75T Back: 18W x 19H Seat Range: 21-28.5
 Arms to Floor: N/A Carton Wt: 26 UPS Wt: 34 COM: N/A
 Carton: 25L x 23W x 12H Cube: 3.9 Options: CG50, SW70
 Features: 1, 4 Control: Pneumatic
 Notes: Chrome Base. ★ NJ In-Stock: -3M

Fabric	List Price
-3M Black	275.00

NEW
250 lbs.



★ **DCY69006** Mesh Back Drafting Chair in Black Faux Leather or Black Fabric Mesh Seat w/Adjustable Footring, Padded Flip Arms and Silver Frame

Overall Size: 24.5W x 24.25D x 43.25 - 50.25H
Seat: 20.75W x 19.75D x 4.75T **Back:** 19W x 20.75H x 2.25T **Seat Range:** 22.5- 29.5
Arms to Floor: 30.5 **Carton Wt:** 40 **UPS Wt:** 43 **COM:** 1.0 yds
Carton: 27L x 26W x 13H **Cube:** 5.28 **Options:** CG50, SW70
Features: 1, 4 **Control:** Pneumatic Height
Notes: Intermediate Travel

NEW

Fabric	Updated List Price
-3M Black Mesh -U6 Black Faux Leather	420.00
A	448.00
B	462.00
C	490.00
R	532.00



★ **DC6900WH** Mesh Back Drafting Chair in Black Faux Leather or Black Fabric Mesh Seat w/Adjustable Footring, Padded Flip Arms and White Frame

Overall Size: 25.25W x 3.755D x 42 - 49H
Seat: 19.75W x 19.75D x 2.75T **Back:** 18.5W x 20H **Seat Range:** 22.75- 29.75
Arms to Floor: 38.75 **Carton Wt:** 37 **UPS Wt:** 45 **COM:** 0.5 yds
Carton: 27L x 26W x 13H **Cube:** 5.28 **Options:** CG50, SW70
Features: 1, 4 **Control:** Pneumatic Height
Notes: Intermediate Travel

NEW

Fabric	Updated List Price
-3M Black Mesh -U6 Black Faux Leather	480.00
A	520.00
B	550.00
C	575.00
R	635.00

Visitor's Chairs



⚙️ **EX31** Visitor's Chair with Molded Foam Seat and Back, Designer Plastic Shell Back, Black Steel Frame and Legs without Arms

Overall Size: 23W x 25D x 32H
Seat: 19W x 19.5D x 3.5T **Back:** 19W x 14.5H x 3.5T **Seat Range:** 18.5 Fixed
Arms to Floor: N/A **Carton Wt:** 22 **UPS Wt:** 31 **COM:** 0.8 yds
Carton: 32L x 22W x 9H **Cube:** 3.67 **Options:** N/A
Features: N/A **Control:** N/A
Notes: Non Stacking

Fabric	List Price
A	180.00
B	190.00
C	205.00
R	228.00



★ ⚙️ **EX35** Visitor's Chair with Molded Foam Seat and Back, Designer Plastic Shell Back, Black Steel Frame and Legs with Arms

Overall Size: 24W x 24D x 33H
Seat: 19.25W x 17.75D x 2.75T **Back:** 18.5W x 16H x 2.5T **Seat Range:** 17.75 Fixed
Arms to Floor: 25.25 **Carton Wt:** 26 **UPS Wt:** 30 **COM:** 0.8 yds
Carton: 33L x 23W x 8H **Cube:** 3.5 **Options:** N/A
Features: N/A **Control:** N/A
Notes: Non Stacking. ★ NJ In-Stock: -231

Fabric	List Price
A	210.00
B	220.00
C	235.00
R	260.00



⚙️ **V3460** Deluxe Sled Base Arm Chair with Plastic Shell Back and Black Steel Frame

Overall Size: 24.5W x 24.25D x 33H
Seat: 19W x 20D x 2T **Back:** 18W x 15.5H x 2T **Seat Range:** 18.5 Fixed
Arms to Floor: 26 **Carton Wt:** 23 **UPS Wt:** 42 **COM:** 0.8 yds
Carton: 34L x 23W x 11H **Cube:** 4.98 **Options:** N/A
Features: N/A **Control:** N/A
Notes: Matches STC3410 and STC3440 Stack Chairs. Non Stacking

Fabric	List Price
A	220.00
B	230.00
C	248.00
R	275.00



★ ⚙️ **V4410** Deluxe Sled Base Arm Chair with Molded Foam Seat and Back, Designer Plastic Shell Back and Black Steel Frame

Overall Size: 23W x 24D x 32H
Seat: 19W x 18D x 3.5T **Back:** 18.5W x 14.5H x 2.5T **Seat Range:** 18.5 Fixed
Arms to Floor: 24.5 **Carton Wt:** 27 **UPS Wt:** 35 **COM:** 0.8 yds
Carton: 32L x 22W x 10H **Cube:** 4.07 **Options:** N/A
Features: N/A **Control:** N/A
Notes: Non Stacking ★ NJ In-Stock: -103 and -231

Fabric	List Price
A	210.00
B	220.00
C	235.00
R	260.00



★ **V4420** Deluxe Sled Base Chair with Molded Foam Seat and Back, Designer Plastic Shell Back and Black Steel Frame

⚙️ **Overall Size:** 23W x 24D x 32H

🌿 **Seat:** 19W x 19.5D x 3.5T **Back:** 18.5W x 14.5H x 2.5T **Seat Range:** 18.5 Fixed

Arms to Floor: N/A **Carton Wt:** 26 **UPS Wt:** 33 **COM:** 0.8 yds

Carton: 32L x 21W x 10H **Cube:** 3.88 **Options:** N/A

Features: N/A **Control:** N/A

Notes: Non Stacking ★ **NJ In-Stock:** -231

Fabric	List Price
A	180.00
B	190.00
C	205.00
R	228.00



★ **STC3030C30** 30 Pack Plastic Seat and Back Stack Chair with Chrome Frame. Assembled with Dolly.

⚙️ **Overall Size:** 21W x 23D x 31H

🌿 **Seat:** 18W x 18.5D **Back:** 21.25W x 12.5H **Seat Range:** 17.5 Fixed

Arms to Floor: N/A **Carton Wt:** 380 **UPS Wt:** No UPS **COM:** N/A

Carton: Ships on Dolly **Cube:** 44.53 **Options:** N/A

Features: N/A **Control:** N/A

Notes: Pricing Reflects 30 Pack with Dolly

Finish	List Price
-2 Grey	3600.00
-3 Black	30 Pack with Dolly
-4 Burgundy	
-7 Blue	



★ **STC3030** 4-Pack Plastic Seat and Back Stack Chair with Chrome Frame. Assembled.

⚙️ **Overall Size:** 22W x 20.75D x 30.75H

🌿 **Seat:** 18W x 18.25D **Back:** 20W x 14H **Seat Range:** 17.5 Fixed

Arms to Floor: N/A **Carton Wt:** 53 **UPS Wt:** No UPS **COM:** N/A

Carton: 36L x 26W x 25H **Cube:** 13.54 **Options:** N/A

Features: N/A **Control:** N/A

Notes: Pricing Reflects 4-Pack See Page 184 for Dolly

Finish	List Price
-2 Grey	528.00
-3 Black	4-Pack
-4 Burgundy	
-7 Blue	



★ **STC3230** 2-Pack Plastic Seat and Back Stack Chair with Chrome Frame. Assembled.

⚙️ **Overall Size:** 21.5W x 23D x 31H

🌿 **Seat:** 18W x 18.5D **Back:** 21.25W x 12.5H **Seat Range:** 17.5 Fixed

Arms to Floor: N/A **Carton Wt:** 33 **UPS Wt:** 93 **COM:** N/A

Carton: 33L x 25W x 23H **Cube:** 10.98 **Options:** N/A

Features: N/A **Control:** N/A

Notes: Pricing Reflects 2-Pack. See Page 184 for Dolly

Finish	List Price
-2 Grey	278.00
-3 Black	2-Pack
-4 Burgundy	
-7 Blue	



★ **STC3410** Stacking Chair with Arms, Plastic Shell Back and Black Steel Frame

⚙️ **Overall Size:** 24.5W x 24.25D x 33H

🌿 **Seat:** 19W x 20D x 2T **Back:** 18.5W x 15.5H x 2T **Seat Range:** 19 Fixed

Arms to Floor: 26 **Carton Wt:** 25 **UPS Wt:** 39 **COM:** 0.8 yds

Carton: 33L x 22W x 11H **Cube:** 4.62 **Options:** N/A

Features: N/A **Control:** N/A

Notes: Will Stack with STC3440. ★ **NJ In-Stock:** -231

Fabric	List Price
A	200.00
B	220.00
C	235.00
R	260.00



★ **STC3440** Stacking Chair with Casters, Arms, Plastic Shell Back and Black Steel Frame

⚙️ **Overall Size:** 24.5W x 24.25D x 33H

🌿 **Seat:** 19W x 20D x 2T **Back:** 18.5W x 15.5H x 2T **Seat Range:** 19 Fixed

Arms to Floor: 26 **Carton Wt:** 26 **UPS Wt:** 39 **COM:** 0.8 yds

Carton: 33L x 22W x 11H **Cube:** 4.62 **Options:** N/A

Features: N/A **Control:** N/A

Notes: Will Stack with STC3410. ★ **NJ In-Stock:** -231

Fabric	List Price
A	220.00
B	235.00
C	248.00
R	275.00



★ **STC865** Stacking Chairs with Black Plastic Seat and Back and Chrome Frame. Available in 30 Pack w/Dolly, 4-Pack and 2-Pack.

⚙️ **Overall Size:** 19W x 23D x 34H
 🌿 **Seat:** 18.25W x 18.5D **Back:** 18.25W x 14H **Seat Range:** 17.75 Fixed
Arms to Floor: N/A **Carton Wt:** 340/50/27 **UPS Wt:** 98 **2-Pack Only**
2-Pack Carton: 35L x 25W x 23H **4-Pack Carton:** 38L x 29W x 23H
30 Pack Carton: Ships on Dolly **Cube:** 46.83/14.67/11.65
Notes: 30 and 4-Packs are NON-UPSable. Pricing Reflects in Packs. See Page 184 for Dolly

Finish	List Price
STC865C30 30 Pack w/Dolly	3600.00
STC865C4 4-Pack	528.00
STC865C2 2-Pack -3 Black	288.00



★ **STC8300** Straight Leg Stacking Chair with Black Plastic Seat and Back and Chrome Frame. Available in 28-Pack w/Dolly, 4-Pack and 2-Pack.

⚙️ **Overall Size:** 19W x 19.5D x 31.5H
 🌿 **Seat:** 16W x 17D **Back:** 16.25W x 13.5H **Seat Range:** 17.5 Fixed
Arms to Floor: N/A **Carton Wt:** 259/39/22 **UPS Wt:** 98 **2-Pack Only**
2-Pack Carton: 35L x 25W x 23H **4-Pack Carton:** 38L x 29W x 23H
28-Pack Carton: Ships on Dolly **Cube:** 43.06/14.67/11.65
Notes: 28 and 4-Packs are NON-UPSable. Pricing Reflects in Packs. See Page 184 for Dolly

Finish	List Price
STC8300C28 28-Pack w/Dolly	2744.00
STC8300C4 4-Pack	440.00
STC8300C2 2-Pack -3 Black	245.00



★ **STC8302** Sled Base Stacking Chair with Black Plastic Seat and Back and Chrome Frame. Available in 28-Pack w/Dolly, 4-Pack and 2-Pack.

⚙️ **Overall Size:** 19W x 19.5D x 31.5H
 🌿 **Seat:** 16W x 17D **Back:** 16.25W x 13.5H **Seat Range:** 17.75 Fixed
Arms to Floor: N/A **Carton Wt:** 296/43/24 **UPS Wt:** 98 **2-Pack Only**
2-Pack Carton: 35L x 25W x 23H **4-Pack Carton:** 38L x 29W x 23H
28-Pack Carton: Ships on Dolly **Cube:** 44.5/14.66/11.64
Notes: 28 and 4-Packs are NON-UPSable. Pricing Reflects in Packs. See Page 184 for Dolly

Finish	List Price
STC8302C28 28-Pack w/Dolly	2744.00
STC8302C4 4-Pack	440.00
STC8302C2 2-Pack -3 Black	245.00



★ **DC8309C** Tall Stacking and Ganging Chair with Plastic Seat and Back and Chrome Frame. Available in 2-Pack, 4-Pack and 25-Pack w/Dolly.

⚙️ **Overall Size:** 20.25W x 22.75D x 43.75H
 🌿 **Seat:** 16W x 16.5D **Back:** 19.25W x 13.5H **Seat Range:** 29.5 Fixed
Arms to Floor: N/A
2-Pack Carton: 46L x 42W x 24H **Cube:** 26.83 **Carton Wt:** 42 **UPS Wt:** NonUPS
4-Pack Carton: 46L x 46W x 24H **Cube:** 29.38 **Carton Wt:** 72 **UPS Wt:** NonUPS
25-Pack Carton: 92L x 45W x 21H **Cube:** 50.31 **Carton Wt:** 396 **UPS Wt:** LTL
Pricing Reflects in Packs. See Page 184 for Dolly.

Finish	List Price
DC8309C25 25-Pack with Dolly	4250.00
DC8309C4 4-Pack	740.00
DC8309C2 2-Pack -3 Black	400.00



★ **DC8658C** Tall Stacking Chair with Plastic Seat and Back and Chrome Frame. Available in 2-Pack and 4-Pack.

⚙️ **Overall Size:** 22W x 25D x 45.75H
 🌿 **Seat:** 18W x 18.5D **Back:** 19W x 13.75H **Seat Range:** 29 Fixed
Arms to Floor: N/A
2-Pack Carton: 26L x 23W x 35H **Cube:** 14.27 **Carton Wt:** 40 **UPS Wt:** NonUPS
4-Pack Carton: 32L x 23W x 37H **Cube:** 17.62 **Carton Wt:** 74 **UPS Wt:** NonUPS
Notes: Pricing Reflects in Packs. See Page 184 for Dolly.

Finish	List Price
DC8658C4 4-Pack	752.00
DC8658C2 2-Pack -3 Black	410.00



⚙️ **STC866** Sled Base Stacking Chair with Chrome Frame Available in 3 Colors of Plastic Seat and Back. Available in 30 Pack w/Dolly, 4-Pack and 2-Pack.

🌿 **Overall Size:** 19W x 22D x 33.5H
Seat: 18.25W x 18D **Back:** 19W x 16.25H **Seat Range:** 17.75 Fixed
Arms to Floor: N/A **Carton Wt:** 335/49/27 **UPS Wt:** 98 **2-Pack Only**
2-Pack Carton: 35L x 25W x 23H **4-Pack Carton:** 38L x 29W x 23H
30 Pack Carton: Ships on Dolly **Cube:** 43.98/14.67/11.65
Notes: 30 and 4-Packs are NON-UPSable. Pricing Reflects in Packs. See Page 184 for Dolly

Finish	List Price
STC866C30 30 Pack w/Dolly	3600.00
STC866C4 4-Pack	528.00
STC866C2 2-Pack -3 Black -4 Burgundy -7 Blue	280.00



★ **183305/183905** Screen Back Visitor's Chair with Black Mesh Seat or Black Faux Leather Seat, Black Frame and Arms

Overall Size: 24W x 23.5D x 32.75H
 Seat: 18.5W x 19.5D x 3.75T Back: 17.25W x 14.5H Seat Range: 18.5 Fixed
 Arms to Floor: 25.75 Carton Wt: 25 UPS Wt: 36 COM: N/A
 Carton: 25L x 21W x 14H Cube: 4.25 Options: N/A
 Features: N/A Control: N/A
 Notes:

250 lbs.

Fabric	Updated List Price
183305 Black Mesh	215.00
183905 Black Faux Leather	215.00

Rental Chairs



★ **RC88** Plastic Chair (10, 4 and 2-Pack)

Overall Size: 17.75W x 17D x 31.5H Pack: 10, 4, 2pc
 Leg Tube: 0.75" x 1.2mm Table Top: N/A
 Carton: 38L x 18W x 12H (10 pc) UPS Wt: 70 Cube: 7.38 Carton Wt: 70
 Carton: 39L x 19W x 5H (4 pc) UPS Wt: 30 Cube: 2.14 Carton Wt: 30
 Carton: 39L x 19W x 5H (2 pc) UPS Wt: 18 Cube: 2.14 Carton Wt: 16
 Notes: See Caddies on Page 184. Stacks on TC8815 Dolly in 10-Pack. **De-
 signed for the rental market.**

250 lbs. NEW

Shipping	List Price
RC883A10 Black	375.00
RC8811A10 White	10 Pack
RC883A4 Black	175.00
RC8811A4 White	4-Pack
RC883A2 Black	90.00
RC8811A2 White	2-Pack



★ **WC7287** Folding Chair with Resin Frame and Padded Seat. Sold in 4-Pack.

Overall Size: 19W x 20.5D x 32H
 Seat: 15.25W x 14.25D x 0.5T Back: 15.75W x 4.5H Seat Range: 18 Fixed
 Arms to Floor: N/A Carton Wt: 45 UPS Wt: 45 COM: N/A
 Carton: 35L x 18W x 10H Cube: 3.6 Options: N/A
 Features: N/A Control: N/A
 Notes: Pricing Reflects 4-Pack.

NEW

Frame/Plastic	List Price
-3 Black	320.00
-11 White	4-Pack

250 lbs.



★ **TC8860** Stacking Caddy for RC88 and WC7287 Chairs with Locking Casters

Overall Size: 37.5W x 19D x 77.25H
 Carton Wt: 50 Cube: 2.72 Pack: 1pc
 Carton: 41L x 23W x 5H UPS Wt: 50
 Notes: Holds up to 62 Folded RC88 Chairs and 32 WC7287 Chairs.
 In grey hammer tone finish.

NEW

Shipping	List Price
UPSable	312.00



★ **TC8815** Stacking Caddy for RC88 and WC7287 Chairs with Locking Casters

Overall Size: 37.5W x 19D x 35H
 Carton Wt: 28 Cube: 2.25 Pack: 1pc
 Carton: 39L x 20W x 5H UPS Wt: 28
 Notes: Holds up to 15 Folded RC88 Chairs and 10 WC7287 Chairs.

NEW

Shipping	List Price
UPSable	200.00



★ **STX8310AC13/STX8310AC4/STX8310AC2** X-Back Guest Stackable Chair in Aluminum Frame with Plastic Seat and Back.

Overall Size: 17W x 20D x 34.25H Pack: 13, 4, 2 pcs
 Seat: 17.25W x 17D Back: 18.25W x 17H Seat Range: 18 Fixed
 Carton: 19L x 20W x 93H Ships on Dolly (13 pcs) Cube: 20.45 Carton Wt: 114
 Carton: 50L x 25W x 21H (4 pcs) UPS Wt: 128 Cube: 15.19 Carton Wt: 38
 Carton: 40L x 25W x 21H (2 pcs) UPS Wt: 103 Cube: 12.15 Carton Wt: 22
 Notes: **Designed for the rental market.**

NEW

Aluminum Frame	List Price
-1 Brown	1690.00
-3 Black	13-Pack
-11 White	568.00
	4-Pack
	312.00
	2-Pack



★ **TC8310D** Stacking Caddy for STX8310AC Stackable Guest Chairs

Overall Size: 21.25W x 31.25D x 41.5H
 Carton 1 (Handle) Wt: 8 Cube: 2.97 Pack: 1pc
 Carton 1: 39L x 22W x 6H UPS Wt: 25
 Carton 2 (Dolly) Wt: 18 Cube: 4.39 Pack: 1pc
 Carton 2: 23L x 22W x 15H UPS Wt: 37
 Notes: Holds up to 8 STX8310AC Stacking Chairs.

NEW

Shipping	List Price
UPSable	280.00



★ **FC8483-231** Nesting Chair with Breathable Mesh Back and Fabric Seat in Black Finish Frame.

Overall Size: 25W x 23.5D x 35.25H
 Seat: 17.5W x 19D x 2T Back: 19.75W x 16.5H Seat Range: 19.5 Fixed
 Arms to Floor: 27 Carton Wt: 50 UPS Wt: 79 COM: 0.75 yd.
 Carton: 26L x 26W x 24H Cube: 9.38 Options: SW72, CG60
 Features: 12 Control: N/A
 Notes: Seat Folds up for Horizontal Nesting. Sold in 2-Pack.
 Set of 2 Clips for Ganging Included. **250 lbs.**

Fabric	List Price
-231 Icon Black Black Finish Frame	550.00 2-Pack
A	575.00
B	605.00
C	635.00
R	775.00



★ **FC8487-231** Nesting Chair with Breathable Mesh Back and Fabric Seat in Titanium Finish Frame.

Overall Size: 25W x 23.5D x 35.25H
 Seat: 17.5W x 19D x 2T Back: 19.75W x 16.5H Seat Range: 19.5 Fixed
 Arms to Floor: 27 Carton Wt: 50 UPS Wt: 79 COM: 0.75 yd.
 Carton: 26L x 26W x 24H Cube: 9.38 Options: SW72, CG60
 Features: 12 Control: N/A
 Notes: Seat Folds up for Horizontal Nesting. Sold in 2-Pack.
 Set of 2 Clips for Ganging Included. **250 lbs.**



Fabric	List Price
-231 Icon Black Titanium Finish Frame	550.00 2-Pack
A	575.00
B	605.00
C	635.00
R	775.00



⚙️ **FC8000NB** Folding Chair with Mocha Plastic Seat and Back and Mocha Frame. Sold in 4-Pack.

Overall Size: 19W x 20.5D x 32H
 Seat: 16W x 16.5D Back: 19W x 9.5H Seat Range: 17.75 Fixed
 Arms to Floor: N/A Carton Wt: 46 UPS Wt: 46 COM: N/A
 Carton: 40L x 20W x 8H Cube: 3.7 Options: N/A
 Features: N/A Control: N/A
 Notes: Pricing Reflects 4-Pack.
 See Page 184 for Dolly

Frame/Plastic	List Price
-1 Mocha/Mocha	280.00 4-Pack
300 lbs.	



★ **FC8000NP** Folding Chair with Black Plastic Seat and Back and Black Frame. Sold in 4-Pack.

Overall Size: 19W x 20.5D x 32H
 Seat: 16W x 16.5D Back: 19W x 9.5H Seat Range: 17.75 Fixed
 Arms to Floor: N/A Carton Wt: 46 UPS Wt: 46 COM: N/A
 Carton: 40L x 20W x 8H Cube: 3.7 Options: N/A
 Features: N/A Control: N/A
 Notes: Pricing Reflects 4-Pack.
 See Page 184 for Dolly

Frame/Plastic	List Price
-3 Black/Black	280.00 4-Pack
300 lbs.	



⚙️ **FC8000NS** Folding Chair with Blue Plastic Seat and Back and Silver Frame. Sold in 4-Pack.

Overall Size: 19W x 20.5D x 32H
 Seat: 16W x 16.5D Back: 19W x 9.5H Seat Range: 17.75 Fixed
 Arms to Floor: N/A Carton Wt: 46 UPS Wt: 46 COM: N/A
 Carton: 40L x 20W x 8H Cube: 3.7 Options: N/A
 Features: N/A Control: N/A
 Notes: Pricing Reflects 4-Pack.
 See Page 184 for Dolly

Frame/Plastic	List Price
-7 Silver/Blue -2 Silver/Grey	280.00 4-Pack
300 lbs.	



⚙️ **FC8000NBG** Folding Chair with Beige Plastic Seat and Back and Beige Frame. Sold in 4-Pack.

Overall Size: 19W x 20.5D x 32H
 Seat: 16W x 16.5D Back: 19W x 9.5H Seat Range: 17.75 Fixed
 Arms to Floor: N/A Carton Wt: 46 UPS Wt: 46 COM: N/A
 Carton: 40L x 20W x 8H Cube: 3.7 Options: N/A
 Features: N/A Control: N/A
 Notes: Pricing Reflects 4-Pack.
 See Page 184 for Dolly

Frame/Plastic	List Price
-11 Beige/Beige	280.00 4-Pack
300 lbs.	



⚙️ **FC8000NW** Folding Chair with Plastic Seat and Back and White Frame. Sold in 4-Pack.
Overall Size: 19W x 20.5D x 32H
Seat: 16W x 16.5D **Back:** 19W x 9.5H **Seat Range:** 17.75 Fixed
Arms to Floor: N/A **Carton Wt:** 46 **UPS Wt:** 46 **COM:** N/A
Carton: 40L x 20W x 8H **Cube:** 3.7 **Options:** N/A
Features: N/A **Control:** N/A
Notes: Pricing Reflects 4-Pack. See Page 184 for Dolly

Frame/Plastic	List Price
-7 White/Blue -11 White/White -16 White/Mint	320.00 4-Pack
300 lbs.	



⚙️ **FC8100NP** Folding Chair with Plastic Fan Back and Matching Fabric Seat with Black Frame. Sold in 4-Pack.
Overall Size: 19.25W x 21.5D x 35.5H
Seat: 16W x 16.25D x 2T **Back:** 18.5W x 17H **Seat Range:** 18.5 Fixed
Arms to Floor: N/A **Carton Wt:** 61 **UPS Wt:** 61 **COM:** N/A
Carton: 45L x 20W x 12H **Cube:** 6.25 **Options:** N/A
Features: N/A **Control:** N/A
Notes: See Page 184 for Dolly Pricing Reflects 4-Pack.

Frame/Fabric	List Price
-3 Black/Black	280.00 4-Pack
300 lbs.	



⚙️ **FC8100NS** Folding Chair with Plastic Fan Back and Matching Fabric Seat with Silver Frame. Sold in 4-Pack.
Overall Size: 19.25W x 21.5D x 35.5H
Seat: 16W x 16.25D x 2T **Back:** 18.5W x 17H **Seat Range:** 18.5 Fixed
Arms to Floor: N/A **Carton Wt:** 61 **UPS Wt:** 61 **COM:** N/A
Carton: 45L x 20W x 12H **Cube:** 6.25 **Options:** N/A
Features: N/A **Control:** N/A
Notes: Pricing Reflects 4-Pack. See Page 184 for Dolly

Frame/Fabric	List Price
-3 Silver/Black -7 Silver/Blue	280.00 4-Pack
300 lbs.	



⚙️ **FC8100NBG** Folding Chair with Plastic Fan Back and Matching Fabric Seat with Beige Frame. Sold in 4-Pack.
Overall Size: 19.25W x 21.5D x 35.5H
Seat: 16W x 16.25D x 2T **Back:** 18.5W x 17H **Seat Range:** 18.5 Fixed
Arms to Floor: N/A **Carton Wt:** 61 **UPS Wt:** 61 **COM:** N/A
Carton: 45L x 20W x 12H **Cube:** 6.25 **Options:** N/A
Features: N/A **Control:** N/A
Notes: Pricing Reflects 4-Pack. See Page 184 for Dolly

Frame/Fabric	List Price
-11 Beige/Beige	280.00 4-Pack
300 lbs.	



★ **FF-22124M/FF-22324M** Folding Chair with Metal Seat and Back. Sold in 4-Pack.
Overall Size: 18.5W x 20D x 29.25H
Seat: 16W x 16D **Back:** 16W x 6.5H **Seat Range:** 18 Fixed
Arms to Floor: N/A **Carton Wt:** 41 **UPS Wt:** 41 **COM:** N/A
Carton: 39L x 20W x 8H **Cube:** 3.6 **Options:** N/A
Features: N/A **Control:** N/A
Notes: Pricing Reflects 4-Pack.

Frame	List Price
-22124M Tan -22324M Black	208.00 4-Pack
300 lbs.	



★ **FF-23124V/FF-23324V** Folding Chair with Vinyl Seat and Back. Sold in 4-Pack.
Overall Size: 18.5W x 20D x 29.25H
Seat: 16W x 16D **Back:** 16W x 6.5H **Seat Range:** 18.5 Fixed
Arms to Floor: N/A **Carton Wt:** 45 **UPS Wt:** 45 **COM:** N/A
Carton: 39L x 20W x 8H **Cube:** 3.6 **Options:** N/A
Features: N/A **Control:** N/A
Notes: Pricing Reflects 4-Pack.

Frame/Fabric	List Price
-23124V Tan -23324V Black	268.00 4-Pack
300 lbs.	



★ **69906-2/69906-3** Mesh Seat and Back Manager's Chair with Flip Arms, Heavy Duty Base with Silver Accents, and Dual Wheel Carpet Casters
Overall Size: 24.5W x 26D x 37.25-41.25H
Seat: 19.25W x 19D **Back:** 18W x 21H **Seat Range:** 18.25-22
Arms to Floor: 26.25 **Carton Wt:** 43 **UPS Wt:** 43 **COM:** N/A
Carton: 27L x 25W x 13H **Cube:** 5.07 **Options:** CG50, SW70
Features: 1, 4, 5, 8, 9 **Control:** 2-to-1 Synchro Tilt
Notes: REPLACES EMH69006 and EMH69007. Patent# US 29/553,650.

Fabric	List Price
69906-2 Silver	395.00
69906-3 Black	



★ **RLY26-WH** White Mesh Seat and Back Manager's Chair with Padded Flip Arms, Heavy Duty Base with Silver Accents, and Dual Wheel Carpet Casters
Overall Size: 24.5W x 26D x 37.25-41.25H
Seat: 19.25W x 19D **Back:** 18W x 21H **Seat Range:** 18.25-22
Arms to Floor: 26.25 **Carton Wt:** 43 **UPS Wt:** 43 **COM:** N/A
Carton: 27L x 25W x 13H **Cube:** 5.07 **Options:** CG50, SW70
Features: 1, 4, 5, 8, 9 **Control:** Locking Tilt
Notes: Patent# US 29/553,650.

Fabric	Updated List Price
-WH White	420.00



★ **SPX61522-3** Breathable Screen Back and Padded Mesh Seat with Adjustable Lumbar Support and Wrap Around Height Adjustable Arms
Overall Size: 25W x 24.75D x 37.5-40.5H
Seat: 19.5W x 18.75D x 2.25T **Back:** 19W x 20H **Seat Range:** 18-21
Arms to Floor: 24.5 **Carton Wt:** 30 **UPS Wt:** 33 **COM:** N/A
Carton: 25L x 24W x 11H **Cube:** 3.82 **Options:** CG50, SW392
Features: 1, 4, 8, 9 **Control:** Locking Tilt
Notes: Angled Nylon Base

Fabric	Updated List Price
-3 Black	315.00

NEW



★ **EM69200PN** Screen Back Armless Task Chair in Fabric Mesh Seat and Dual Wheel Carpet Casters
Overall Size: 22.5W x 23.75D x 36 - 40H
Seat: 19.5W x 19D x 3T **Back:** 18W x 19H **Seat Range:** 17.25 - 21
Arms to Floor: N/A **Carton Wt:** 22 **UPS Wt:** 34 **COM:** N/A
Carton: 25L x 23W x 12H **Cube:** 4.32 **Options:** CG50, SW392
Features: 1, 4, 8 **Control:** Pneumatic
Notes: Black Nylon Base. ★ NJ In-Stock: -3M, -6, -18, & -512

Fabric	List Price
-3M Black	195.00
-6 Green	
-18 Orange	
-261 Pink	
-512 Purple	

NEW

250 lbs.



★ **EM69202N** Screen Back Chair in Fabric Mesh Seat, Flip Arms with Silver Accents and Dual Wheel Carpet Casters
Overall Size: 24W x 23.25D x 36.5-40.25H
Seat: 19.25W x 19D x 3T **Back:** 17.5W x 19.25H **Seat Range:** 18 - 21.75
Arms to Floor: 25.25 **Carton Wt:** 29 **UPS Wt:** 37 **COM:** N/A
Carton: 25L x 23W x 12H **Cube:** 4.32 **Options:** CG50, SW392
Features: 1, 4, 5, 8, 9 **Control:** Locking Tilt
Notes: Black Nylon Base. ★ NJ In-Stock: -3M, -6, -18, & -512

Fabric	List Price
-3M Black	225.00
-6 Green	
-18 Orange	
-512 Purple	

NEW

250 lbs.



★ **EMH69203S** Screen Back Chair in Fabric Mesh Seat, Silver Coated Padded Arms and Dual Wheel Carpet Casters
Overall Size: 26W x 22.5D x 36.5 - 40.25H
Seat: 19.75W x 18.75D x 2.75T **Back:** 18W x 19.25H **Seat Range:** 17 - 21.5
Arms to Floor: 25.5 **Carton Wt:** 29 **UPS Wt:** 34 **COM:** N/A
Carton: 25L x 23W x 12H **Cube:** 3.99 **Options:** CG50, SW392
Features: 1, 4, 5, 8, 9 **Control:** Locking Tilt
Notes: Silver Coated Base. ★ NJ In-Stock: -3M

Fabric	List Price
-3M Black	225.00
-5 Navy	
-6 Green	
-18 Orange	
-512 Purple	

NEW

250 lbs.



★ **EM69203C** Screen Back Chair in Faux Leather Seat, Chrome Padded Arms and Dual Wheel Carpet Casters
Overall Size: 25.25W x 22D x 36.75 - 40.75H
Seat: 19.25W x 19D x 3T **Back:** 18W x 19.25H **Seat Range:** 18 - 21.75
Arms to Floor: 25.75 **Carton Wt:** 32 **UPS Wt:** 37 **COM:** N/A
Carton: 25L x 23W x 13H **Cube:** 4.32 **Options:** CG50, SW70
Features: 1, 4, 5, 8, 9 **Control:** Locking Tilt
Notes: Chrome Base. ★ NJ In-Stock: -U6, -U11 & -U42

NEW

Fabric	List Price
-U6 Black	250.00
-U9 Red	
-U11 White	
-U28 Cream	
-U42 Charcoal Grey	
250 lbs.	



★ **DCY69200PC** Screen Back Armless Drafting Chair in Black Fabric Seat with Adjustable Footring and Dual Wheel Carpet Casters
Overall Size: 22W x 22.5D x 40.75-47.75H
Seat: 18.75W x 18D x 2.75T **Back:** 18W x 19H **Seat Range:** 21-28.5
Arms to Floor: N/A **Carton Wt:** 26 **UPS Wt:** 34 **COM:** N/A
Carton: 25L x 23W x 12H **Cube:** 3.9 **Options:** CG50, SW70
Features: 1, 4 **Control:** Pneumatic
Notes: Chrome Base. ★ NJ In-Stock: -3M

NEW

Fabric	List Price
-3M Black	275.00
250 lbs.	



★ **EMH69216-3M/EMH69216-U6** Mesh Back Manager's Chair with Faux Leather or Mesh Seat, Adjustable Padded Flip Arms and Silver Nylon Base
Overall Size: 26.5W x 25.5D x 38.25 - 41.5H
Seat: 23W x 21.5D x 3T **Back:** 17.75W x 21.25H x 2T **Seat Range:** 19-22
Arms to Floor: 25.25 **Carton Wt:** 33 **UPS Wt:** 40 **COM:** N/A
Carton: 26L x 26W x 12H **Cube:** 4.69 **Options:** CG50, SW70
Features: 1, 4, 5, 8, 9 **Control:** Locking Tilt
Notes: Silver Frame

Fabric	List Price
-3M Black Mesh or -U6 Black Faux Leather	330.00



★ **EMH6921C-EC3** Mesh Back Manager's Chair in Bonded Leather Seat, Adjustable Padded Flip Arms & Chrome Base
Overall Size: 26.5W x 25.5D x 38.25 - 41.5H
Seat: 23W x 21.5D x 3T **Back:** 17.75W x 21.25H x 2T **Seat Range:** 19-22
Arms to Floor: 25.25 **Carton Wt:** 34 **UPS Wt:** 40 **COM:** N/A
Carton: 27L x 25W x 12H **Cube:** 4.6 **Options:** CG50, SW392
Features: 1, 4, 5, 8, 9 **Control:** Locking Tilt
Notes:

Fabric	List Price
-EC-3 Chrome/ Black Bonded Leather	330.00



★ **EMH69176** Mesh Back Manager's Chair w/Faux Leather or Fabric Seat, Adjustable Mesh Padded Arms, and Black Nylon Base with Silver Accents
Overall Size: 23.5W x 27D x 36.5 - 40.5H
Seat: 20W x 20D x 2.75T **Back:** 17.75W x 21.25H x 2T **Seat Range:** 17-20.75
Arms to Floor: 28 **Carton Wt:** 31 **UPS Wt:** 40 **COM:** 1 yd.
Carton: 26L x 26W x 12H **Cube:** 4.69 **Options:** CG50, SW70
Features: 1, 4, 5, 8, 9 **Control:** Locking Tilt
Notes: ★ NJ In-Stock: -3



Fabric	List Price
-3 Black or -U6 Black Faux Leather	295.00
A	310.00
B	325.00
C	345.00
R	375.00



★ **EMH6918T** Mesh Back Manager's Chair w/Faux Leather or Fabric Seat, Adjustable PU Padded Arms, and Base. Dark Water Transfer Accents on Arms, Base & Back.
Overall Size: 23.5W x 27D x 36.5 - 40.5H
Seat: 20W x 20D x 2.75T **Back:** 17.75W x 21.25H x 2T **Seat Range:** 17-20.75
Arms to Floor: 27 **Carton Wt:** 32 **UPS Wt:** 40 **COM:** 1 yd.
Carton: 26L x 26W x 12H **Cube:** 4.69 **Options:** CG50, SW70
Features: 1, 4, 5, 8, 9 **Control:** Locking Tilt
Notes: ★ NJ In-Stock: -U6



Fabric	List Price
-3 Black or Faux Leather	350.00
-U6 Black	
A	370.00
B	390.00
C	410.00
R	445.00



★ **EM35207-3** Screen Back and Mesh Seat Manager's Chair with Coated Finish Base and Accents
Overall Size: 26W x 26.25D x 42H
Seat: 19.75W x 20.75D x 4T **Back:** 17.75W x 21.75H **Seat Range:** 17.25-21
Arms to Floor: 28.5 **Carton Wt:** 34 **UPS Wt:** 36 **COM:** N/A
Carton: 27L x 25W x 11H **Cube:** 4.29 **Options:** CG50, SW70
Features: 1, 4, 7, 8, 9 **Control:** 2-to-1 Synchro Tilt
Notes:

Fabric	Updated List Price
Titanium/Black Mesh Seat	350.00



★ **EM35206-EC3/EM35201-EC1** Screen Back and Bonded Leather Seat Manager's Chair with Coated Finish Base and Accents
Overall Size: 26W x 26.25D x 42H
Seat: 19.75W x 20.75D x 4T **Back:** 17.75W x 21.75H **Seat Range:** 17.25-21
Arms to Floor: 28.5 **Carton Wt:** 35 **UPS Wt:** 37 **COM:** N/A
Carton: 26L x 26W x 11H **Cube:** 4.32 **Options:** CG50, SW70
Features: 1, 4, 7, 8, 9 **Control:** 2-to-1 Synchro Tilt
Notes:

Fabric	Updated List Price
EM35206-EC3 Silver/Black	350.00
EM35201-EC1 Cocoa/ Espresso	



★ **EM50219-3V** Woven Mesh Back & Faux Leather Seat Task Chair with Height Adjustable Arms, Angle Nylon Base and Black Carpet Casters
Overall Size: 27.25W x 24.25D x 39.75-43.25H
Seat: 20.5W x 19D x 3T **Back:** 19.5W x 21.5H **Seat Range:** 18.25-21.75
Arms to Floor: 26.25 **Carton Wt:** 34 **UPS Wt:** 34 **COM:** N/A
Carton: 27L x 26W x 10H **Cube:** 4.06 **Options:** CG50, SW70
Features: 1, 4, 5, 8, 9 **Control:** Locking Tilt
Notes:

Fabric	Updated List Price
-3V Black Vinyl	345.00



EM50727 Screen Back Task Chair with Adjustable Arms and Dual Wheel Carpet Casters
Overall Size: 25.5W x 23D x 41H
Seat: 19W x 19D x 2.5T **Back:** 17.25W x 20H **Seat Range:** 17 -21.5
Arms to Floor: 25 **Carton Wt:** 35 **UPS Wt:** 38 **COM:** .75 yd
Carton: 25L x 24W x 13H **Cube:** 4.51 **Options:** CG50, SW70
Features: 1, 4, 5, 8, 9 **Control:** Locking Tilt Control
Notes:

Fabric	Updated List Price
-3 Black Mesh or -2 Grey	300.00
A	315.00
B	332.00
C	350.00
R	370.00



★ **EM51022N** Woven Mesh Back Task Chair with Dual Wheel Carpet Casters
Overall Size: 24.5W x 23D x 41H
Seat: 20W x 18.25D x 2.5T **Back:** 18.5W x 18.5H **Seat Range:** 17.75 -22.25
Arms to Floor: 24.5 **Carton Wt:** 30 **UPS Wt:** 38 **COM:** .75 yd
Carton: 25L x 24W x 13H **Cube:** 4.51 **Options:** SW392
Features: 1, 4, 5, 8, 9 **Control:** Locking Tilt Control
Notes: REPLACES 47903A.

Fabric	Updated List Price
-3 Black Mesh or -2 Grey	265.00
A	280.00
B	295.00
C	310.00
R	330.00



★ **599302** Woven Mesh Back Chair with Black Mesh or Custom Fabric Seat, Height Adjustable Arms, Adjustable Lumbar and Nylon Base
Overall Size: 25.75W x 23.25D x 44H
Seat: 19.25W x 19.5D x 3T **Back:** 20.25W x 22.5H **Seat Range:** 18 -22.5
Arms to Floor: 25.25 **Carton Wt:** 37 **UPS Wt:** 37 **COM:** .5 yds
Carton: 26L x 23W x 11H **Cube:** 3.81 **Options:** CG50, SW70
Features: 1, 4, 5, 8, 9 **Control:** Locking Tilt
Notes: Dual Wheel Carpet Casters

Fabric	Updated List Price
Black Mesh	310.00
A	326.00
B	345.00
C	364.00
R	385.00

★ NJ In Stock



★ **599402** Woven Mesh Back Chair with Black Leather Seat, Height Adjustable Arms, Adjustable Lumbar and Nylon Base
Overall Size: 25.75W x 23.25D x 44H
Seat: 19.25W x 19.5D x 3T **Back:** 20.25W x 22.5H **Seat Range:** 18 -22.5
Arms to Floor: 25.25 **Carton Wt:** 37 **UPS Wt:** 37 **COM:** N/A
Carton: 26L x 24W x 11H **Cube:** 3.97 **Options:** CG50, SW70
Features: 1, 4, 5, 8, 9 **Control:** Locking Tilt
Notes: Dual Wheel Carpet Casters

Fabric	Updated List Price
Black Bonded Leather	330.00



EM59722 Screen Back Over Designer Contour Shell Chair with Black Mesh or Custom Fabric Seat and Fabric Padded Arms
Overall Size: 26.75W x 25D x 42H
Seat: 19W x 20D x 4T **Back:** 19.75W x 22H **Seat Range:** 17 -20.75
Arms to Floor: 26.75 **Carton Wt:** 36 **UPS Wt:** 37 **COM:** .75 yds
Carton: 25L x 23W x 13H **Cube:** 4.32 **Options:** CG50, SW70
Features: 1, 4, 5, 8, 9 **Control:** Locking Tilt
Notes: Dual Wheel Carpet Casters

Fabric	Updated List Price
-3 Black Mesh	300.00
A	315.00
B	335.00
C	355.00
R	380.00



EM5972V-3 Screen Back Over Designer Contour Shell Visitor's Chair with Black Mesh Seat and Padded Arms
Overall Size: 26.75W x 25D x 38.5H
Seat: 19W x 20D x 4T **Back:** 19.75W x 22H **Seat Range:** 18 Fixed
Arms to Floor: 26.75 **Carton Wt:** 31 **UPS Wt:** 39 **COM:** .75 yds
Carton: 25L x 21W x 15H **Cube:** 4.55 **Options:** N/A
Features: N/A **Control:** N/A
Notes:



Fabric	Updated List Price
-3 Black Mesh	282.00
A	300.00
B	320.00
C	340.00
R	365.00



EM59722-EC3 Screen Back Over Designer Contour Shell Chair with Black Bonded Leather Seat and Black Bonded Leather Padded Arms
Overall Size: 26.75W x 25D x 42H
Seat: 19W x 20D x 4T **Back:** 19.75W x 22H **Seat Range:** 17 -20.75
Arms to Floor: 26.75 **Carton Wt:** 36 **UPS Wt:** 37 **COM:** N/A
Carton: 25L x 23W x 13H **Cube:** 4.32 **Options:** CG50, SW70
Features: 1, 4, 5, 8, 9 **Control:** Locking Tilt
Notes: Dual Wheel Carpet Casters

Fabric	Updated List Price
Bonded Leather -EC3 Black	330.00



EM5972V-EC3 Screen Back Over Designer Contour Shell Visitor's Chair with Black Bonded Leather Seat and Padded Arms
Overall Size: 26.75W x 25D x 38.5H
Seat: 19W x 20D x 4T **Back:** 19.75W x 22H **Seat Range:** 18 Fixed
Arms to Floor: 26.75 **Carton Wt:** 31 **UPS Wt:** 39 **COM:** N/A
Carton: 25L x 21W x 15H **Cube:** 4.55 **Options:** N/A
Features: N/A **Control:** N/A
Notes:







Fabric	Updated List Price
Bonded Leather -EC3 Black	315.00

Self-Skinned Urethane Seating





⚙️ **KH206** Saddle Seat Stool with Seat Angle Adjustment and Dual Wheel Carpet Casters
Overall Size: 27W x 27D x 29.75-39.5H
Seat: 13.5W x 9.25D x 2.5T **Back:** N/A **Seat Range:** 23.25-33
Arms to Floor: N/A **Carton Wt:** 24 **UPS Wt:** 25 **COM:** N/A
Carton: 25L x 25W x 8H **Cube:** 2.89 **Options:** CG50, SW70, SK1, SK5
Features: 1, 4, 5, 9 **Control:** Pneumatic Height with Seat Tilt
Notes:

Fabric	List Price
Black Self-Skinned Urethane	220.00

	<p>⚙️ KH503 Intermediate Stool with Dual Wheel Carpet Casters</p> <p>🌿</p> <p>Overall Size: 22.25W x 22.5D x 17.25 - 24.75H Seat: 14.25W x 14.25D x 1.5T Back: N/A Seat Range: 17.25 - 24.75 Arms to Floor: N/A Carton Wt: 19 UPS Wt: 19 COM: N/A Carton: 23L x 22W x 5H Cube: 1.46 Options: CG50, SW70, SK7, SK5 Features: 1, 4 Control: Pneumatic Height Notes:</p>	<p>Fabric</p> <p>Black Self-Skinned Urethane</p>	<p>List Price</p> <p>170.00</p>
	<p>★ KH507 Stool with Adjustable Footrest and Dual Wheel Carpet Casters</p> <p>⚙️</p> <p>🌿</p> <p>Overall Size: 22.5W x 22.5D x 30.5H Seat: 14.25W x 14.25D x 1.5T Back: N/A Seat Range: 20.5 - 30.5 Arms to Floor: N/A Carton Wt: 21 UPS Wt: 21 COM: N/A Carton: 23L x 23W x 7H Cube: 2.14 Options: CG50, SW70 Features: 1, 4, Control: Pneumatic Height Notes:</p>	<p>Fabric</p> <p>Black Self-Skinned Urethane</p>	<p>List Price</p> <p>260.00</p>
	<p>★ KH520 Task Chair with Dual Wheel Carpet Casters</p> <p>⚙️</p> <p>🌿</p> <p>Overall Size: 18.5W x 22.5D x 37.5H Seat: 18.5W x 18D x 1.5T Back: 17W x 13.25H x 1T Seat Range: 16 -21 Arms to Floor: N/A Carton Wt: 31 UPS Wt: 31 COM: N/A Carton: 24L x 22W x 8H Cube: 2.44 Options: CG50, SW70, SK7, SK5 Features: 1, 2, 3, 4 Control: Pneumatic Height Notes: REPLACES KH220</p>	<p>Fabric</p> <p>Black Self-Skinned Urethane</p>	<p>List Price</p> <p>350.00</p>
	<p>⚙️ KH580 Ergonomic Chair with Seat Tilt and Back Angle Adjustment and Dual Wheel Carpet Casters</p> <p>🌿</p> <p>Overall Size: 18.5W x 22.5D x 37.5H Seat: 18.5W x 18D x 1.5T Back: 17W x 13.25H x 1T Seat Range: 16 -21 Arms to Floor: N/A Carton Wt: 36 UPS Wt: 36 COM: N/A Carton: 24L x 22W x 8H Cube: 2.44 Options: CG50, SW70, SK7, SK5 Features: 1, 2, 4, 10 Control: Multi Task Notes: REPLACES KH280</p>	<p>Fabric</p> <p>Black Self-Skinned Urethane</p>	<p>List Price</p> <p>415.00</p>
	<p>★ KH540 Intermediate Drafting Chair with Adjustable Footrest and Dual Wheel Carpet Casters</p> <p>⚙️</p> <p>🌿</p> <p>Overall Size: 18.5W x 22.5D x 35 - 44.5H Seat: 18.5W x 18D x 1.5T Back: 17W x 13.25H x 1T Seat Range: 18 - 25.5 Arms to Floor: N/A Carton Wt: 37 UPS Wt: 37 COM: N/A Carton: 25L x 25W x 9H Cube: 3.25 Options: CG50, SW70 Features: 1, 2, 3, 4 Control: Pneumatic Height Notes: REPLACES KH440</p>	<p>Fabric</p> <p>Black Self-Skinned Urethane</p>	<p>List Price</p> <p>365.00</p>
	<p>★ KH550 Standard Drafting Chair with Adjustable Footrest and Dual Wheel Carpet Casters</p> <p>⚙️</p> <p>🌿</p> <p>Overall Size: 18.5W x 22.5D x 48.75H Seat: 18.5W x 18D x 1.5T Back: 17 x 13.25H x 1T Seat Range: 22 - 32 Arms to Floor: N/A Carton Wt: 37 UPS Wt: 37 COM: N/A Carton: 25L x 25W x 9H Cube: 3.26 Options: CG50, SW70 Features: 1, 2, 3, 4 Control: Pneumatic Height Notes: REPLACES KH450</p>	<p>Fabric</p> <p>Black Self-Skinned Urethane</p>	<p>List Price</p> <p>440.00</p>





 **KH570 Intermediate Ergonomic Drafting Chair with Seat Tilt, Back Angle Adjustment, Adjustable Footrest and Dual Wheel Carpet Casters**
 **Overall Size:** 18.5W x 21.5D x 41.75H
Seat: 18.5W x 18D x 1.5T **Back:** 17W x 13.25H x 1T **Seat Range:** 18 - 25.5
Arms to Floor: N/A **Carton Wt:** 41 **UPS Wt:** 41 **COM:** N/A
Carton: 25L x 25W x 9H **Cube:** 3.26 **Options:** CG50, SW70
Features: 1, 2, 4, 10 **Control:** Multi Task
Notes: REPLACES KH470



Fabric	List Price
Black Self-Skinned Urethane	460.00

Options





 **04-ARMS-3 Height Adjustable Arms**
 **Carton Wt:** 9 **Cube:** 0.61
 **Designed For:** 2902, 2817 & 98341 Only
List: 85.00





 **07-ARMS-3 2-Way Adjustable Arms**
 **Carton Wt:** 9 **Cube:** 0.61
 **Designed For:** See Individual Chair Options
List: 90.00



 **SK-7 Stool Kit w/18" Chrome Ring**
 **Carton Wt:** 5 **Cube:** 0.63
 **Designed For:** See Individual Chair Options - Adds 7.5 inches to Seat Height - Ring is Height Adjustable
List: 48.00





 **SW70 Soft Wheel Caster (set of 5)**
 **Carton Wt:** 2 **Cube:** 0.2
 **Designed For:** Most Work Smart & Space Chairs - See individual Chair Options
List: 30.00 (set of 5)





 **SW392 Soft Wheel Caster (set of 5)**
 **Carton Wt:** 2 **Cube:** 0.2
 **Designed For:** Angled Base Chairs See Individual Chair Options
Updated List: 32.00 (set of 5)





 **CG50 Floor Glides (set of 5)**
 **Carton Wt:** 2 **Cube:** 0.2
 **Designed For:** Most Work Smart Chairs & Space Drafting Chairs - See Individual Chair Options
List: 25.00 (set of 5)





 **SW72 Soft Wheel Caster (set of 4)**
 **Carton Wt:** 2 **Cube:** 0.2
 **Designed For:** FC84 Series
List: 25.00 (set of 4)



 **CG60 Glides (Fixed Position - set of 4)**
 **Carton Wt:** 2 **Cube:** 0.2
 **Designed For:** FC84 Series
List: 25.00 (set of 4)

NEW



 **SK-5 Stool Kit w/19" Nylon Ring**
 **Carton Wt:** 7 **UPS Wt:** 8 **Cube:** 0.92
 **Designed For:** See Individual Chair Options - Adds 7.5 inches to Seat Height - Ring is Height Adjustable
List: 60.00

Breakroom Collection

• WHITE BEAN PANICOLA w/ KAIANI
grilled cubeta bread

• SHRIMP SCAMPI lemon butter garlic, white wine 9⁹⁹

• BRUSCHETTA + topanese, warmed goat cheese, marinated red pepper, caponata, roasted garlic 10⁹⁹

• CAPPRESE PLATE 5⁹⁹
tomatoes, fresh mozzarella + perito

• CURED MEAT + CHEESE PLATE 10⁹⁹
house-made Pate, Provolone, Fanned Salami, selected Cheese

BEERS on TOP - Pint 4⁹⁹
HOUSE WINE 5⁹⁹/g

SWEETS

Cannoli 4⁹⁹
Pizzelle Ice Cream Sandwich 4⁹⁹

• DREIBERGER
• HOAG - RED WINE

Specialty Wine on top

ON TOP Pint 4⁹⁹
Bale Breaker Field w/ Bale Pie
LIKE NAUGHTY NELLIE
Pera
Anthem - Draft Cider

Special Wine Drinks

Chardonnay lavender syrup, splash of lime 7⁹⁹
Prosecco, ginger syrup, splash of orange 7⁹⁹
Red Wine - Cinnamon syrup, splash of spice 7⁹⁹



shown: BRW3030A4-AY



◆ **PTR2830A4 Patterson Metal Chair with Arms and Accented Backrest, Fully Assembled**
Overall Size: 22.5W x 20.5D x 30.25H
Seat: 13.25W x 13.75D **Back:** 12.25W x 14.75H **Seat Range:** 17.5 Fixed
Carton Wt: 52 **UPS Wt:** 117
Carton: 45L x 23W x 23H **Cube:** 13.78
Notes: Pricing Reflects 4-Pack. Indoor Use Only.
2-Pack: PTR2830A2: Carton Wt: 27 UPS Wt: 91
Carton: 35L x 23W x 23H Cube: 10.71 *New Color

Finish	List Price
-3 Black	464.00
-9 Red	
-11 White	
-16 Mint	
-18 Orange	
2-Pack	280.00



◆ **PTR3024A4 Patterson 24" Backless Metal Stool, Fully Assembled**
Overall Size: 16W x 16D x 24H
Seat: 12W x 12D **Seat Range:** 24 Fixed
Carton Wt: 41 **UPS Wt:** 60
Carton: 40L x 18W x 17H **Cube:** 7.08
Notes: Pricing Reflects 4-Pack, stackable. Indoor Use Only.
2-Pack: PTR3024A2: Carton Wt: 22 UPS Wt: 45
Carton: 30L x 18W x 17H Cube: 5.3 *New Color

Finish	List Price
-3 Black	348.00
-9 Red	
-11 White	
-16 Mint	
-18 Orange	
2-Pack	200.00



◆ **PTR3030A4 Patterson 30" Backless Metal Stool, Fully Assembled**
Overall Size: 17W x 17D x 30.25H
Seat: 12W x 12D x 1.5T **Seat Range:** 30.25 Fixed
Carton Wt: 46 **UPS Wt:** 73
Carton: 46L x 18W x 18H **Cube:** 8.62
Notes: Pricing Reflects 4-Pack, stackable. Indoor Use Only.
2-Pack: PTR3030A2: Carton Wt: 25 UPS Wt: 57 Carton: 36L x 18W x 18H
Cube: 6.75 *New Color

Finish	List Price
-3 Black	384.00
-9 Red	
-11 White	
-16 Mint	
-18 Orange	
2-Pack	232.00



shown: -C210-1

◆ **BRW29A4 Bristow Antique Metal Chair, Fully Assembled**
Overall Size: 17W x 20D x 33.5H
Seat: 13.25W x 13.75D **Back:** 17W x 17H **Seat Range:** 17.25 Fixed
Carton Wt: 56 **UPS Wt:** 116
Carton: 42L x 27W x 21H **Cube:** 13.78
Notes: Pricing Reflects 4-Pack
2-Pack: BRW29A2: Carton Wt: 28 UPS Wt: 74
Carton: 40L x 20W x 19H Cube: 8.79

Finish	List Price
-C230 Matte Black	652.00
-C210-1 Matte Galvanized	
2-Pack	364.00



shown: -CP

◆ **BRW29A4 Bristow Antique Metal Chair, Fully Assembled**
Overall Size: 17W x 20D x 33.5H
Seat: 13.25W x 13.75D **Back:** 17W x 17H **Seat Range:** 17.25 Fixed
Carton Wt: 56 **UPS Wt:** 116
Carton: 42L x 27W x 21H **Cube:** 13.78
Notes: Pricing Reflects 4-Pack. Indoor Use Only.
2-Pack:
BRW29A2:
Carton Wt: 28 UPS Wt: 74
Carton: 40L x 20W x 19H Cube: 8.79

Finish	List Price
-AB Antique Black	652.00
-AC Antique Copper	
-AW Antique White	
-AY Antique Yellow	
-ASB Antique Sky Blue	
-ARD Antique Red	
-AOR Antique Orange	
-GM Gunmetal	
-AP Antique Pink	
-AL Antique Lime	
-ARB Antique Royal Blue	
-CP Copper	
-ATQ Antique Turquoise	
-BC Brushed Copper	
-BS Brushed Silver	
-BRC Brushed Red Copper	
2-Pack	364.00 (2-Pack)

***New Colors**



(-BRC) Brushed Red Copper

(-BS) Brushed Silver

(-BC) Brushed Copper

New Colors | BRW29A4 / BRW29A2



shown: -AL

◆ **BRW3026A4 Bristow 26" Antique Metal Barstool, Fully Assembled**

Overall Size: 16.25W x 16.25D x 26.25H

Seat: 12W x 12D x 1.5T **Back:** N/A **Seat Range:** 26.25 Fixed

Carton Wt: 48 **UPS Wt:** 74

Carton: 44L x 19W x 18H **Cube:** 8.7

Notes: Pricing Reflects 4-Pack, stackable. Indoor Use Only.

2-Pack:

BRW3026A2:

Carton Wt: 24 **UPS Wt:** 54

Carton: 19L x 18W x 32H **Cube:** 6.3

Finish

- AB Antique Black
- AC Antique Copper
- AW Antique White
- AY Antique Yellow
- ASB Antique Sky Blue
- ARD Antique Red
- AOR Antique Orange
- GM Gunmetal
- AP Antique Pink
- AL Antique Lime
- ARB Antique Royal Blue
- CP Copper
- ATQ Antique Turquoise

List Price

476.00

274.00
(2-Pack)



shown: -ARB

◆ **BRW3030A4 Bristow 30" Antique Metal Barstool, Fully Assembled**

Overall Size: 16.75W x 16.75D x 30.25H

Seat: 12W x 12D x 1.5T **Back:** N/A **Seat Range:** 30.25 Fixed

Carton Wt: 53 **UPS Wt:** 87

Carton: 49L x 19W x 19H **Cube:** 10.23

Notes: Pricing Reflects 4-Pack, stackable. Indoor Use Only.

2-Pack:

BRW3030A2:

Carton Wt: 28 **UPS Wt:** 64

Carton: 36L x 19W x 19H **Cube:** 7.12

Finish

- AB Antique Black
- AC Antique Copper
- AW Antique White
- AY Antique Yellow
- ASB Antique Sky Blue
- ARD Antique Red
- AOR Antique Orange
- GM Gunmetal
- AP Antique Pink
- AL Antique Lime
- ARB Antique Royal Blue
- CP Copper
- ATQ Antique Turquoise

List Price

540.00





286.00
(2-Pack)

 **work smart**



Folding Resin Multi Purpose



	<p>★ FT6634 4' Resin Multi Purpose/Training Flip Table with Black Steel Tubular Frames, Locking Casters, and Cord Management Overall Size: 48W x 24D x 29.25H Pack: 1pc Leg Tube: 1.125" x 1.2mm Table Top: 45mm Thick Carton Wt: 36 Carton: 49L x 25W x 5H UPS Wt: 36 Cube: 3.5 Notes:</p>	<p>Shipping UPSable</p>	<p>Updated List Price 310.00</p>
	<p>★ FT6635 5' Resin Multi Purpose/Training Flip Table with Black Steel Tubular Frames, Locking Casters, and Cord Management Overall Size: 60W x 24D x 29.25H Pack: 1pc Leg Tube: 1.5" x 1.2mm Table Top: 45mm Thick Carton Wt: 44 Carton: 62L x 26W x 6H UPS Wt: 48 Cube: 5.59 Notes:</p>	<p>Shipping UPSable</p>	<p>Updated List Price 370.00</p>
	<p>BT244 Adjustable Height (13.5-28) Deluxe Personal Tray Table (4-Pack) Overall Size: 30W x 19.5D x 28H Pack: 4pc Leg Tube: .5" x 1.0mm Table Top: 42mm Thick Carton Wt: 51 Carton: 39L x 21W x 10H UPS Wt: 51 Cube: 4.73 Notes:</p>	<p>Shipping UPSable</p>	<p>Updated List Price 285.00 4-Pack</p>
	<p>★ BT04Q 4' Resin Multi Purpose Table Overall Size: 48W x 24D x 29.25H Pack: 1pc Leg Tube: 1" x 0.8mm Table Top: 45mm Thick Carton Wt: 22 Carton: 49L x 25W x 3H UPS Wt: 21 Cube: 2.12 Notes:</p>	<p>Shipping UPSable</p>	<p>Updated List Price 125.00</p>
	<p>BT04FA 4' Height Adjustable Fold in Half Resin Multi Purpose Table Overall Size: 48W x 24D x 29.25H Pack: 1pc Range: 22.5 -35.5 Leg Tube: 1" & .75" x 0.9mm Table Top: 42mm Thick Carton Wt: 24 Carton: 26L x 25W x 4H UPS Wt: 23 Cube: 1.50</p>	<p>Shipping UPSable</p>	<p>Updated List Price 140.00</p>

★ *NJ In Stock*



BT04W 4' Resin Multi Purpose Table
 Overall Size: 48W x 30D x 29.25H Pack: 1pc
 Leg Tube: 1.75" x 0.8mm Table Top: 47mm Thick Carton Wt: 36
 Carton: 51L x 33W x 3H UPS Wt: 31 Cube: 2.92
 Notes:

NEW

Shipping
 UPSable

Updated List Price
 165.00



★ **BT05Q 5' Resin Multi Purpose Table**
 Overall Size: 60W x 30D x 29.25H Pack: 1pc
 Leg Tube: 1.125" x 0.9mm Table Top: 45mm Thick Carton Wt: 30
 Carton: 61L x 31W x 3H UPS Wt: 30 Cube: 3.28
 Notes: See Caddies on Page 184

Shipping
 UPSable
 Oversized Package

Updated List Price
 165.00



BT5FQW 5' Resin Multi Purpose Center Fold Table with Transport Wheels
 Overall Size: 61W x 30D x 29.25H Pack: 1pc
 Leg Tube: 1.0" x 0.8mm Table Top: 1.75" Thick Carton Wt: 29
 Carton: 33L x 30W x 4H UPS Wt: 29 Cube: 2.29
 Notes:

Shipping
 UPSable
 Oversized Package

Updated List Price
 175.00



★ **BT06Q 6' Resin Multi Purpose Table**
 Overall Size: 72W x 30D x 29.25H Pack: 1pc
 Leg Tube: 1.125" x 1.0mm Table Top: 45mm Thick Carton Wt: 38
 Carton: 73L x 31W x 3H UPS Wt: 35 Cube: 3.92
 Notes: See Caddies on Page 184

Shipping
 UPSable
 Oversized Package

Updated List Price
 175.00



★ **BT6FQ 6' Resin Center Fold Multi Purpose Table**
 Overall Size: 72W x 30D x 29.25H Pack: 1pc
 Leg Tube: 1.125" x 0.9mm Table Top: 45mm Thick Carton Wt: 34
 Carton: 38L x 30W x 4H UPS Wt: 34 Cube: 2.63
 Notes:

Shipping
 UPSable

Updated List Price
 190.00



BT6FQW 6' Resin Multi Purpose Center Fold Table with Transport Wheels
 Overall Size: 72.5W x 30D x 29.75H Pack: 1pc
 Leg Tube: 1.125" x 1.1mm Table Top: 2.25" Thick Carton Wt: 43
 Carton: 39L x 31W x 5H UPS Wt: 43 Cube: 3.49
 Notes:

Shipping
 UPSable
 Oversized Package

Updated List Price
 215.00



BT06A 6' Height Adjustable Resin Multi Purpose Table
 Overall Size: 72W x 30D x 29.25H Pack: 1pc Range: 29.25 -37
 Leg Tube: 1.125" x 1.0mm Table Top: 45mm Thick Carton Wt: 38
 Carton: 73L x 31W x 3H UPS Wt: 35 Cube: 3.92
 Notes:

Shipping
 UPSable
 Oversized Package

Updated List Price
 190.00



★ **BT08Q 8' Resin Multi Purpose Table**
 Overall Size: 96W x 30D x 29.25H Pack: 1pc
 Leg Tube: 1.125" x 1.0mm Table Top: 50mm Thick Carton Wt: 49
 Carton: 98L x 31W x 3H UPS Wt: Non UPSable Cube: 5.27
 Notes: See Caddies on Page 184

Shipping
 Non UPSable

Updated List Price
 255.00



★ **BT36 36" Square Resin Table**
 Overall Size: 36W x 36D x 29H Pack: 1pc
 Leg Tube: 38.1mm x 1.0mm Table Top: 45mm Thick Carton Wt: 27
 Carton: 37L x 37W x 3H UPS Wt: 25 Cube: 2.37
 Notes:

Shipping
 UPSable

Updated List Price
 150.00













★ **BT48Q 48" Round Resin Multi Purpose Table**
 Overall Size: 48W x 48D x 29.25H Pack: 1pc
 Leg Tube: 31.125" x 1.0mm Table Top: 45mm Thick Carton Wt: 33
 Carton: 49L x 49W x 3H UPS Wt: 38 Cube: 4.17
 Notes: See Caddies on Page 184

Shipping
 UPSable
 Oversized Package

Updated List Price
 210.00

★ *NJ In Stock*

	<p>★ BT60Q 60" Round Resin Multi Purpose Table Overall Size: 60W x 60D x 29.25H Pack: 1pc Leg Tube: 1.25" x 1.0mm Table Top: 50mm Thick Carton Wt: 50 Carton: 61L x 61W x 3H UPS Wt: Non UPSable Cube: 6.46 Notes: See Caddies on Page 184</p>	<p>Shipping Non UPSable</p>	<p>Updated List Price 330.00</p>
	<p>★ BT71Q 71" Round Resin Multi Purpose Table Overall Size: 71W x 71D x 29.25H Pack: 1pc Leg Tube: 1.5" x 1.0mm Table Top: 55mm Thick Carton Wt: 63 Carton: 72L x 72W x 3H UPS Wt: Non UPSable Cube: 9.0 Notes: See Caddies on Page 184</p>	<p>Shipping Non UPSable</p>	<p>Updated List Price 445.00</p>
	<p>★ BT22 Resin Training Multi Purpose Table Overall Size: 70.5W x 19.5D x 29.5H Pack: 1pc Leg Tube: 1" x 1.0mm Table Top: 55mm Thick Carton Wt: 28 Carton: 71L x 21W x 3H UPS Wt: 28 Cube: 2.58 Notes:</p>	<p>Shipping UPSable</p>	<p>Updated List Price 160.00</p>
	<p>★ PC-02 Resin Chair (4-Pack Blow Mold) Overall Size: 18.5W x 21.9D x 33.2H Pack: 4pc Leg Tube: 1.125" x 1.1mm Table Top: N/A Carton Wt: 51 (4-Pack) Carton: 44L x 19W x 11H UPS Wt: 45 Cube: 5.32 Notes: See Caddies on Page 184</p>	<p>Shipping UPSable 300 lbs.</p>	<p>Updated List Price 304.00 4-Pack</p>
	<p>PC-03 Resin Chair (4-Pack Blow Mold) Overall Size: 18.5W x 22D x 33.2H Pack: 4pc Leg Tube: 1.125" x 0.9mm Table Top: N/A Carton Wt: 51 (4-Pack) Carton: 44L x 19W x 12H UPS Wt: 51 Cube: 5.80 Notes: See Caddies on Page 184</p>	<p>Shipping UPSable 300 lbs.</p>	<p>Updated List Price 304.00 4-Pack</p>
	<p>★ PC-54 Plastic Chair (4-Pack) Overall Size: 17.75W x 17.5D x 34.5H Pack: 4pc Leg Tube: 0.75" x 0.85mm Table Top: N/A Carton Wt: 28 (4-Pack) Carton: 42L x 18W x 7H UPS Wt: 28 Cube: 3.06 Notes: See Caddies on Page 184</p>	<p>Shipping UPSable 225 lbs.</p>	<p>Updated List Price 180.00 4-Pack</p>
	<p>PCT-05 5 Piece Folding Set (4 chairs and 36" x 36" fold in half table) Overall Size Table: 36W x 36D x 27.75H Pack: 1 set Overall Size Chair: 17.75W x 17.5D x 34.5H Carton Wt: 49 Carton: 37L x 20W x 9H UPS Wt: 49 Cube: 3.85 Notes:</p>	<p>Shipping UPSable 225 lbs.</p>	<p>Updated List Price 310.00</p>
	<p>QT7205-05 5-Piece Folding Set (4 chairs and table) Overall Size Table: 72W x 29.5D x 29.25H Pack: 1 set Overall Size Chair: 17.75W x 16.25D x 30H Carton Wt: 59 Carton: 41L x 39W x 8H UPS Wt: 63 Cube: 7.4 Notes:</p>	<p>Shipping UPSable Oversized Package 225 lbs.</p>	<p>Updated List Price 462.00</p>
	<p>QT7302-03 3-Piece Folding Set (2 chairs and table) Overall Size Table: 48W x 24D x 22.75-32.5H Pack: 1 set Overall Size Chair: 17.75W x 16.25D x 30H Carton Wt: 36 Carton: 38L x 26W x 7H UPS Wt: 36 Cube: 4.0 Notes: Adjustable Height Table</p>	<p>Shipping UPSable 225 lbs.</p>	<p>Updated List Price 255.00</p>
	<p>QT3965 3 Piece Folding Table and Bench Set (2 benches and one BT6FQ) Overall Size Table: 72W x 30D x 29.25H Pack: 1 set Overall Size Bench: 72.5W x 12D x 17.5H Carton Wt: 72 Carton: 40L x 32W x 8H UPS Wt: 72 Cube: 5.92 Notes:</p>	<p>Shipping UPSable 225 lbs.</p>	<p>Updated List Price 432.00</p>

★ NJ In Stock



PC-15F Fold in Half Bench
Overall Size: 72.5W x 12D x 17.5H **Pack:** 1pc
Leg Tube: 1" x 0.8mm **Table Top:** N/A **Carton Wt:** 20
Carton: 38L x 13W x 5H **UPS Wt:** 20 **Cube:** 1.42
Notes:

Shipping
 UPSable
225 lbs.

Updated List Price
 122.00

Caddies and Dollies



★ **TC102** Caddy for BT05Q, BT06Q, BT08Q or BT06A
Overall Size: 76W x 30.3D x 45.3H **Pack:** 1pc
Handle Tube: 1.125" x 1.8mm **Carton Wt:** 75
Carton: 78L x 34W x 6H **UPS Wt:** 78 **Cube:** 9.21
Notes: Holds up to 20 BT05Q, BT06Q , 18 BT08Q and 20 BT06A

Shipping
 UPSable
 Oversized Package

Updated List Price
 395.00



★ **TC103** Caddy for PC02 / PC03 Chairs
Overall Size: 34.4W x 18.8D x 74.8H **Pack:** 1pc
Square Tube: 31.8mm x 31.8mm x 1.2mm **Carton Wt:** 49
Carton: 47L x 20W x 5H **UPS Wt:** 49 **Cube:** 3.26
Notes: Holds up to 28 PC02 or PC03 Chairs

Shipping
 UPSable

Updated List Price
 265.00



★ **TC104** Caddy for PC54 Chairs
Overall Size: 37.6W x 18.7D x 77.5H **Pack:** 1pc
Square Tube: 31.8mm x 31.8mm x 1.2mm **Carton Wt:** 47
Carton: 40L x 22W x 5H **UPS Wt:** 47 **Cube:** 2.55
Notes: Holds up to 60 PC54 Chairs

Shipping
 UPSable

Updated List Price
 265.00



★ **TC106** Caddy for BT48Q, BT60Q and BT71 Round Tables
Overall Size: 52W x 32.8D x 40.2H **Pack:** 1pc
Handle Tube: 1.25" x 1.0mm **Carton Wt:** 76
Carton: 53L x 35W x 5H **UPS Wt:** 76 **Cube:** 5.36
Notes: Holds up to 14 BT71Q, 15 BT60Q or 17 BT48Q

Shipping
 UPSable
 Oversized Package

Updated List Price
 375.00

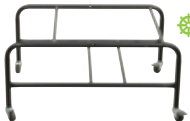

★ **DOL865** Stacking Dolly for STC865, STC866 and STC3030 Chairs with 2 locking Casters
 🌿 **Overall Size:** 31.5W x 24.5D x 15.25H
Carton Wt: 16 **Cube:** 7.95 **Pack:** 1pc
Carton: 33L x 26W x 16H **UPS Wt:** 67
Notes: Fully assembled.

Shipping
 UPSable

Updated List Price
 185.00

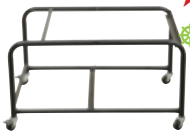

★ **DOL8300** Stacking Dolly for STC8300 Chairs with 2 Locking Casters
 🌿 **Overall Size:** 31.5W x 21.75D x 18.25H
Carton Wt: 18 **Cube:** 7.95 **Pack:** 1pc
Carton: 33L x 26W x 16H **UPS Wt:** 67
Notes: Fully assembled.

Shipping
 UPSable

Updated List Price
 185.00



★ **DOL8000** Stacking Dolly for FC8000 & FC8100 Chairs with 2 Locking Casters
 🌿 **Overall Size:** 71W x 19.25D x 44.5H
Carton Wt: 40 **Cube:** 5.42 **Pack:** 1pc
Carton: 72L x 20W x 7H **UPS Wt:** 49
Notes: Holds up to 32 Folded FC8000 Chairs and 22 Folded FC8100 Chairs.

Shipping
 UPSable

Updated List Price
 185.00

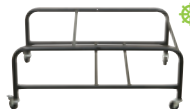

★ **DOL8302** Stacking Dolly for STC8302 and DC8309 Chairs with 2 Locking Casters
 🌿 **Overall Size:** 31.5W x 23.25D x 16.5H
Carton Wt: 16 **Cube:** 7.95 **Pack:** 1pc
Carton: 33L x 26W x 16H **UPS Wt:** 67
Notes: Fully assembled.

Shipping
 UPSable

Updated List Price
 185.00

work smart

◆ **Light Duty Seating**



KCW773

shown with
HZN25

	<p>★ SC117 Basic Task Chair with Molded Foam Seat and Back</p> <p>⚙️ Overall Size: 19.5W x 21.5D x 38H Seat: 18W x 17D x 2.5T Back: 16W x 10.5H x 2T Seat Range: 16.75 -22.5 Arms to Floor: N/A Carton Wt: 22 UPS Wt: 24 COM: 0.8 yds Carton: 29L x 21W x 8H Cube: 2.81 Options: 07, CG50, SW70, SK1, SK5 Features: 1, 2, 3, 4 Control: Pneumatic Notes: ★ NJ In-Stock: -231</p>	<p>Fabric</p> <p>A B C</p>	<p>List Price</p> <p>140.00 148.00 156.00</p>
	<p>F PROGRAM 200 lbs.</p>		

	<p>★ SC66 Task Chair with Saddle Seat and Height Adjustable Soft Padded Arms</p> <p>Overall Size: 28W x 23.5D x 40H Seat: 19.5W x 18D x 3T Back: 17.75W x 18H x 2.5T Seat Range: 18 -22.25 Arms to Floor: 25.5 Carton Wt: 36 UPS Wt: 37 COM: 1.75 yds Carton: 25L x 23W x 13H Cube: 4.32 Options: CG50, SW70 Features: 1, 4, 5, 8, 9 Control: Locking Tilt Notes: ★ NJ In-Stock: -231</p>	<p>Fabric</p> <p>A B C</p>	<p>Updated List Price</p> <p>315.00 335.00 355.00</p>
	<p>F PROGRAM 200 lbs.</p>		

Specialty Seating

	<p>KCM1420 Ergonomically Designed Knee Chair with Casters and Memory Foam</p> <p>Overall Size: 17W x 25.25D x 20.5H Seat: 17W x 12.5D x 2.5T Knee Pads: 16.5W x 10.5D x 2.5T Seat Range: 20.5 -28 Arms to Floor: N/A Carton Wt: 20 UPS Wt: 20 COM: N/A Carton: 26L x 19W x 8H Cube: 2.28 Options: N/A Features: N/A Control: Manual Notes:</p>	<p>Fabric</p> <p>Coal</p>	<p>Updated List Price</p> <p>212.00</p>
	<p>200 lbs.</p>		

	<p>KCM1425 Ergonomically Designed Knee Chair with 5 Star Base, Casters and Memory Foam</p> <p>Overall Size: 17W x 22.25D x 22.5H Seat: 17W x 13.75D x 3.5T Knee Pad: 16.5W x 12.5H x 3.25T Seat Range: 18.5 -23 Carton Wt: 20 UPS Wt: 25 COM: N/A Carton: 22L x 21W x 11H Cube: 2.94 Options: N/A Features: 1, 4 Control: Pneumatic Notes:</p>	<p>Fabric</p> <p>Coal</p>	<p>Updated List Price</p> <p>250.00</p>
	<p>200 lbs.</p>		

	<p>KCW773/KCW778 Ergonomically Designed Mahogany Finished Wood Knee Chair with Casters and Memory Foam</p> <p>Overall Size: 17W x 31D x 25H Seat: 17W x 12.25D x 2.5T Knee Pad: 18.25W x 10.5H x 2.5T Seat Range: 22 -25 Arms to Floor: N/A Carton Wt: 19 UPS Wt: 19 COM: N/A Carton: 26L x 18W x 8H Cube: 2.16 Options: N/A Features: N/A Control: Manual Notes:</p>	<p>Fabric</p> <p>KCW773 Coal/ Mahogany</p> <p>KCW778 Coal/Esspresso</p>	<p>Updated List Price</p> <p>278.00</p>
	<p>200 lbs.</p>		

	<p>DOR26 Dorado Office Chair with Fixed Padded Arms and Chrome Finish Base and Accents</p> <p>Overall Size: 17W x 31D x 37.75H Seat: 17.5W x 16.5D Back: 16.75W x 18H x 1T Seat Range: 18 -22 Arms to Floor: 23.5 Carton Wt: 29 UPS Wt: 29 COM: N/A Carton: 24L x 24W x 10H Cube: 3.33 Options: CG50, SW70 Features: 1, 4, 5, 8, 9 Control: Locking Tilt Notes:</p>	<p>Fabric</p> <p>-ES Espresso -BK Black -WH White -RD Red -GY Grey</p>	<p>Updated List Price</p> <p>298.00</p>
	<p>* New Color</p> <p>200 lbs.</p>		

◆ Office Seating under "◆ General Warranty" are not intended for commercial use (40-hour work week)

★ NJ In Stock ⚙️ TAA Compliant ⚙️ GREENGUARD Certified

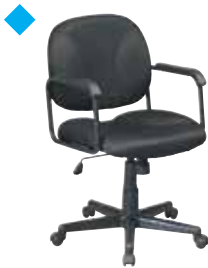

EX3301 Manager's Chair with Loop Arms

Overall Size: 22.5W x 25.5D x 38.25H
 Seat: 20.5W x 20.75D x 4.25T Back: 20W x 17H x 3.5T Seat Range: 17.25 -21
 Arms to Floor: 26.25 Carton Wt: 31 UPS Wt: 37 COM: 1.0 yds
 Carton: 24L x 24W x 13H Cube: 4.33 Options: CG50, SW70
 Features: 1, 4, 5, 8, 9 Control: Locking Tilt
 Notes:



Fabric	Updated List Price
A	225.00
B	238.00
C	250.00

200 lbs.



★ **EX3302** Matching Conference/Visitor's Chair to EX3301

Overall Size: 21.75W x 25D x 34.5H
 Seat: 20.5W x 20.75D x 4.25T Back: 20W x 17H x 3.5T Seat Range: 18.25 Fixed
 Arms to Floor: 26.25 Carton Wt: 25 UPS Wt: 34 COM: 1.0 yds
 Carton: 27L x 23W x 11H Cube: 3.95 Options: N/A
 Features: N/A Control: N/A
 Notes: ★ NJ In-Stock: -231



Fabric	Updated List Price
A	190.00
B	200.00
C	212.00

200 lbs.



★ **EC3393** Bonded Leather Executive Chair

Overall Size: 23W x 25D x 41.75H
 Seat: 19W x 19D x 3T Back: 19W x 23H x 3T Seat Range: 16.75 -20.5
 Arms to Floor: 24 Carton Wt: 32 UPS Wt: 32 COM: N/A
 Carton: 25L x 24W x 11H Cube: 3.81 Options: CG50, SW70
 Features: 1, 4, 5, 8, 9 Control: Locking Tilt
 Notes:

Fabric	Updated List Price
Bonded Leather -EC3 Black	240.00

200 lbs.



★ **EC22070** High Back Bonded Leather Executive Chair

Overall Size: 26.5W x 27D x 45.5H
 Seat: 21W x 18.5D x 3T Back: 21W x 25.5H x 5T Seat Range: 17.5 -21.5
 Arms to Floor: 25 Carton Wt: 38 UPS Wt: 49 COM: N/A
 Carton: 30L x 24W x 14H Cube: 5.83 Options: CG50, SW70
 Features: 1, 4, 5, 8, 9 Control: Locking Tilt
 Notes:

Fabric	Updated List Price
Bonded Leather -EC3 Black	315.00

200 lbs.



★ **FL7480** High Back Faux Leather Executive Chair with Padded Arms

Overall Size: 26W x 27.25D x 47.5H
 Seat: 20.25W x 19.5D x 4.5T Back: 20W x 26.25H x 4.5T Seat Range: 19 -22.75
 Arms to Floor: 27 Carton Wt: 38 UPS Wt: 54 COM: N/A
 Carton: 28L x 26W x 15H Cube: 6.31 Options: CG50, SW70
 Features: 1, 4, 5, 8, 9 Control: Locking Tilt
 Notes:

Fabric	Updated List Price
Faux Leather -U6 Black	332.00

200 lbs.

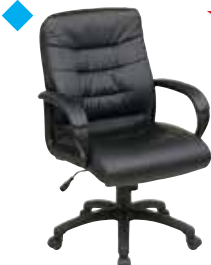

★ **FL7481** Mid Back Faux Leather Executive Chair with Padded Arms

Overall Size: 26W x 27.25D x 43.5H
 Seat: 20.25W x 19.5D x 4.5T Back: 20W x 21H x 4T Seat Range: 19 -22.75
 Arms to Floor: 27 Carton Wt: 38 UPS Wt: 44 COM: N/A
 Carton: 25L x 24W x 15H Cube: 5.20 Options: CG50, SW70
 Features: 1, 4, 5, 8, 9 Control: Locking Tilt
 Notes:

Fabric	Updated List Price
Faux Leather -U6 Black	292.00

200 lbs.

◆ Office Seating under "◆ General Warranty" are not intended for commercial use (40-hour work week)

★ NJ In Stock  TAA Compliant

	<p>★ FL7485 Faux Leather Visitor's Chair with Padded Arms and Sled Base</p> <p>Overall Size: 26W x 26.75D x 41.5H Seat: 26W x 20D x 4.5T Back: 19.5W x 22.5H x 5T Seat Range: 19.75 Fixed Arms to Floor: 28 Carton Wt: 39 UPS Wt: 47 COM: N/A Carton: 27L x 22W x 16H Cube: 5.5 Options: N/A Features: N/A Control: N/A Notes:</p>	<p>Fabric</p> <p>Faux Leather -U6 Black</p>	<p>Updated List Price</p> <p>278.00</p>
			200 lbs.

Drafting Chairs

	<p>★ ST235V-3 Chrome Finish Stool with Vinyl Seat and Back and Dual Wheel Carpet Casters</p> <p>Overall Size: 23W x 24D x 39.25H Seat: 16W x 16D x 4T Back: 16W x 10H x 3T Seat Range: 19.5 - 25 Arms to Floor: N/A Carton Wt: 19 UPS Wt: 25 COM: N/A Carton: 23L x 22W x 10H Cube: 2.93 Options: CG50, SW70 Features: 1, 4 Control: Pneumatic Height Notes: REPLACES ST245V</p>	<p>Fabric</p> <p>Black Vinyl</p>	<p>Updated List Price</p> <p>260.00</p>
			<p>Dillon</p> <p>290.00</p>

	<p>★ ST428V-3 Chrome Finish Backless Stool with Vinyl Seat and Dual Wheel Carpet Casters</p> <p>Overall Size: 23W x 23D x 26.5H Seat: 16W x 16D x 4T Back: N/A Seat Range: 19.5 - 25 Arms to Floor: N/A Carton Wt: 18 UPS Wt: 21 COM: N/A Carton: 24L x 22W x 8H Cube: 2.44 Options: CG50, SW70 Features: 1, 4 Control: Pneumatic Height Notes: REPLACES ST418V</p>	<p>Fabric</p> <p>Black Vinyl</p>	<p>Updated List Price</p> <p>208.00</p>
			<p>Dillon</p> <p>230.00</p>

	<p>★ DC420V-3 Chrome Finish Ergonomic Drafting Chair with Teardrop Footrest, Casters and Glides Included</p> <p>Overall Size: 18W x 24.5D x 50H Seat: 18W x 18D x 3T Back: 15W x 12H x 1.5T Seat Range: 26 - 36 Arms to Floor: N/A Carton Wt: 31 UPS Wt: 31 COM: N/A Carton: 24L x 23W x 11H Cube: 3.51 Options: CG50, SW70 Features: 1, 4 Control: Pneumatic Height Notes: Teardrop Footrest is not Adjustable</p>	<p>Fabric</p> <p>Black Vinyl</p>	<p>Updated List Price</p> <p>372.00</p>
			200 lbs.

Ventilated Seating

	<p>★ EM20700-F3 Screen Back Task Chair with Black Fabric Seat and Dual Wheel Carpet Casters</p> <p>Overall Size: 20.5W x 23.5D x 35-39.25H Seat: 19.25W x 18D x 3.5T Back: 17.75W x 17.5H Seat Range: 18 - 22.25 Arms to Floor: N/A Carton Wt: 24 UPS Wt: 28 COM: N/A Carton: 26L x 22W x 10H Cube: 3.3 Options: CG50, SW70 Features: 1, 4 Control: Pneumatic Seat Height Notes:</p>	<p>Fabric</p> <p>-F3 Black Fabric Seat</p>	<p>Updated List Price</p> <p>175.00</p>
			200 lbs.

	<p>★ EM20722-F3 Screen Back Task Chair with Black Fabric Seat, "T" Arms and Dual Wheel Carpet Casters</p> <p>Overall Size: 23.75W x 23.5D x 35-39.25H Seat: 19.25W x 18D x 3.5T Back: 17.75W x 17.5H Seat Range: 18 - 22.25 Arms to Floor: 25.25 Carton Wt: 28 UPS Wt: 28 COM: N/A Carton: 26L x 22W x 10H Cube: 3.3 Options: CG50, SW70 Features: 1, 4, 5, 8, 9 Control: Locking Tilt Notes:</p>	<p>Fabric</p> <p>-F3 Black Fabric Seat</p>	<p>Updated List Price</p> <p>200.00</p>
			200 lbs.

◆ Office Seating under "◆ General Warranty" are not intended for commercial use (40-hour work week)

★ NJ In Stock

	<p>★ EM22800 Screen Back Task Chair with Black Fabric Seat and Dual Wheel Carpet Casters</p> <p>Overall Size: 22W x 22D x 38.25H Seat: 18.25W x 18.25D x 2.75T Back: 17W x 16.5H Seat Range: 17.5 -21.25 Arms to Floor: N/A Carton Wt: 21 UPS Wt: 27 COM: N/A Carton: 23L x 22W x 11H Cube: 3.22 Options: CG50, SW70 Features: 1, 4 Control: Pneumatic Seat Height Notes:</p>	<p>Fabric</p> <p>-F3 Black Fabric Seat</p> <p>200 lbs.</p>	<p>Updated List Price</p> <p>175.00</p>
----------------------------------------------------------------------------------	-----------------------------------------------------------------------------------------------------------------------------------------------------------------------------------------------------------------------------------------------------------------------------------------------------------------------------------------------------------------------------------------------------------------------------------------------------------------------------------------------	-------------------------------------------------------------------	-----------------------------------------

	<p>★ EM22822 Screen Back Task Chair with Black Fabric Seat, "T" Arms and Dual Wheel Carpet Casters</p> <p>Overall Size: 25.75W x 22.75D x 38H Seat: 18.75W x 18.5D x 2.25T Back: 16.75W x 18H Seat Range: 16.75 -20.5 Arms to Floor: 24.75 Carton Wt: 27 UPS Wt: 27 COM: N/A Carton: 23L x 22W x 11H Cube: 3.22 Options: CG50, SW70 Features: 1, 4, 5, 8, 9 Control: Locking Tilt Notes:</p>	<p>Fabric</p> <p>-F3 Black Fabric Seat</p> <p>200 lbs.</p>	<p>Updated List Price</p> <p>212.00</p>
----------------------------------------------------------------------------------	--------------------------------------------------------------------------------------------------------------------------------------------------------------------------------------------------------------------------------------------------------------------------------------------------------------------------------------------------------------------------------------------------------------------------------------------------------------------------------------------------------------	-------------------------------------------------------------------	-----------------------------------------

	<p>★ EM2910/EM2910V Task Chair with Screen Back and Dual Wheel Carpet Casters</p> <p>Overall Size: 18.5W x 22.25D x 40H Seat: 18.5W x 18D x 3T Back: 17.5W x 17H Seat Range: 17.75 -23 Arms to Floor: N/A Carton Wt: 24 UPS Wt: 31 COM: N/A Carton: 24L x 24W x 11H Cube: 3.67 Options: CG50, SW70 Features: 1, 3, 4 Control: Pneumatic Height Notes:</p>	<p>Fabric</p> <p>EM2910 -231 Black Icon EM2910V Black Vinyl</p> <p>200 lbs.</p>	<p>Updated List Price</p> <p>230.00</p>
-----------------------------------------------------------------------------------	---------------------------------------------------------------------------------------------------------------------------------------------------------------------------------------------------------------------------------------------------------------------------------------------------------------------------------------------------------------------------------------------------------------------------------------------------------------------------	-------------------------------------------------------------------------------------------------------------	-----------------------------------------

	<p>EMH69096-3 Mesh Seat and Screen Back Manager's Chair with Padded Silver Arms and Nylon Base</p> <p>Overall Size: 23.25W x 25.25D x 37.5H Seat: 19.5W x 19.5D x 2.5T Back: 18.5W x 20.25H x .75T Seat Range: 17-20 Arms to Floor: 25.5 Carton Wt: 29 UPS Wt: 36 COM: N/A Carton: 27L x 25W x 11H Cube: 4.29 Options: CG50, SW70 Features: 1, 4, 5, 8, 9 Control: Locking Tilt Notes:</p>	<p>Fabric</p> <p>-3 Black Mesh -7 Blue -512 Purple</p> <p>200 lbs.</p>	<p>Updated List Price</p> <p>282.00</p>
------------------------------------------------------------------------------------	------------------------------------------------------------------------------------------------------------------------------------------------------------------------------------------------------------------------------------------------------------------------------------------------------------------------------------------------------------------------------------------------------------------------------------------------------------------------------------------------------------	-------------------------------------------------------------------------------------------------------------------------	-----------------------------------------

	<p>★ 583713 Screen Back Chair with Black Mesh Seat, Titanium Finish Base, Adjustable Lumbar and Height Adjustable Arms</p> <p>Overall Size: 28W x 23D x 45.5H Seat: 22W x 19.5D x 3T Back: 21W x 26H Seat Range: 18.25 -22.75 Arms to Floor: 26.25 Carton Wt: 42 UPS Wt: 42 COM: 1 yd. Carton: 30L x 25W x 11H Cube: 4.77 Options: CG50, SW70 Features: 1, 4, 5, 8, 9 Control: Locking Tilt Notes: Dual Wheel Carpet Casters</p>	<p>Fabric</p> <p>Black Mesh</p> <p>A B C R</p> <p>200 lbs.</p>	<p>Updated List Price</p> <p>292.00 310.00 325.00 342.00 360.00</p>
------------------------------------------------------------------------------------	--------------------------------------------------------------------------------------------------------------------------------------------------------------------------------------------------------------------------------------------------------------------------------------------------------------------------------------------------------------------------------------------------------------------------------------------------------------------------------------------------------------------------------------------------	-----------------------------------------------------------------------------------	-------------------------------------------------------------------------------------

	<p>★ 583814 Screen Back Chair with Black Leather Seat, Chrome Finish Base, Adjustable Lumbar and Height Adjustable Arms</p> <p>Overall Size: 28W x 23D x 45.5H Seat: 22W x 19.5D x 3T Back: 21W x 26H Seat Range: 18.25 -22.75 Arms to Floor: 26.25 Carton Wt: 42 UPS Wt: 42 COM: 1 yd. Carton: 30L x 25W x 11H Cube: 4.77 Options: CG50, SW70 Features: 1, 4, 5, 8, 9 Control: Locking Tilt Notes: Dual Wheel Carpet Casters</p>	<p>Fabric</p> <p>Black Leather</p> <p>A B C R</p> <p>200 lbs.</p>	<p>List Price</p> <p>320.00 338.00 356.00 375.00 395.00</p>
------------------------------------------------------------------------------------	---------------------------------------------------------------------------------------------------------------------------------------------------------------------------------------------------------------------------------------------------------------------------------------------------------------------------------------------------------------------------------------------------------------------------------------------------------------------------------------------------------------------------------------------------	--------------------------------------------------------------------------------------	-----------------------------------------------------------------------------

◆ Office Seating under "◆ General Warranty" are not intended for commercial use (40-hour work week)

★ NJ In Stock 🌿 GREENGUARD Certified



CUSTOM FABRIC PROGRAM
**AVAILABLE
FABRICS**



colored mesh • dove • dillon • gavotte • festival • interlink • icon • legend • diamond • ridgecrest
tracery • couture • castillo • twilight • freeflex® • transport • fine tune • city park • lifesaver • crave
trinket • brackle • champagne • element • key largo • cosmopolitan

unbeatable service

available fabrics



custom fabric program | Choices in Fabric. Wherever chairs are identified with our CF graphic, you have hundreds of choices in fabric. Solids, patterns and textures. Simple and complex. Vinyls. Hospitality/healthcare-safe performance fabrics. Recycled selections. Choices for every environment. Many are IN STOCK. You can also choose C.O.M. (customer's own material). **Custom Fabrics add 3-4 weeks to the lead time.** Digital representations of fabrics are available at www.officestar.net/fabrics



recycled fabric (page 200) | **100% Recycled.** Wherever chairs are identified with our CF graphic, you can select 100% recycled polyester fabrics from our Champagne, Elements and Ladders collections. All surpass 50K - 100 double-rub durability testing as well as CAL 117, NFPA 260 and UFAC Class 1 flammability standards, so you can protect your immediate environment as well as our planet. That's big-picture thinking. Digital representations of fabrics are available at www.officestar.net/fabrics

A | grade fabric

NEW Fun Colors



-3M | Black



-5 | Royal Blue



-6 | Green



-7 | Blue



-9 | Red

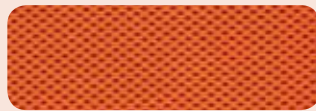

-18 | Orange

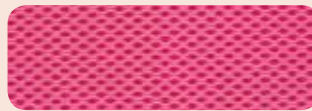

-261 | Pink



-512 | Purple

• contents 100% polyester • flammability CAL117•

Colored Mesh



-5811 | Steel



-5812 | Rouge



-5819 | Violet



-5877 | Sky



-5879 | Olive



-5881 | Jade

• contents 70% polyester, 30% cotton • surface abrasion 70,000 double rubs (Wyzenbeek), 35,000 double rubs (Martindale) • lightfastness 40 hours, Class 4 (AATCC Test Method 16E) • colorfastness Wet - Class 4.5, Dry - Class 4 (AATCC Test Method 8) • flammability Cal. 117, Section E, CS-191-53, Class 1 BIFMA FF1-78, NFPA 260-1989, UFAC, Class 1, B.S. 5852 Part 1: 1979 Ignition Source 0, Smouldering Cigarette •

Dove

Dillon (antimicrobial)



Attractive antimicrobial PVC free polyurethane available in 8 eye-catching finishes, and is engineered to meet 200,000 double rubs and CAL117 flammability requirements.



-R100 | Lipstick

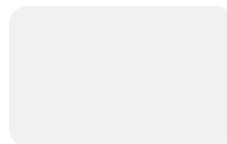

-R101 | Snow



-R102 | Java

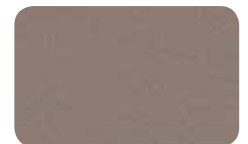

-R103 | Stratus



-R104 | Buff



-R105 | Blue



-R106 | Sage



-R107 | Black

contents 100% polyurethane back 70% polyester, 30% cotton • surface abrasion 200,000+ cycles • treatments N/A break strength warp 130 lbs, weft 120 lbs • flammability CA Tech Bull. 117, Section E UFAC Class 1 NFPA 260 Class 1

*Due to differences in dye batches and variations in printing as well as viewing environments and uneven color fading there will be slight variations in color. Exact matching may not be possible.

Ridgecrest



-K015 | Meadow



-K016 | Beach

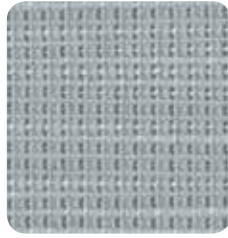

-K017 | Tide Pool



-K018 | Putty



-K019 | Chocolate



-K020 | Ink

contents 100% polyester • **surface abrasion** exceeds 100,000 cycles (Wyzenbeek-#10 cotton duck abradant) • **backing** acrylic
break strength WARP 80 lbs, WEFT 68 lbs (ASTMD4034) • **seam slippage** WARP 84 lbs, WEFT 72 lbs (ASTMD4034)
light fastness class 4/40 hrs min (AATCC16A) • **color fastness** Class 4 (ASTM D3597, AATC 8) Wet, Class 5 (ASTM D3597, AATCC 8) Dry • **flammability** CA Tech Bull. 117, Section E (CS-191-153) UFAC Class 1

Gavotte

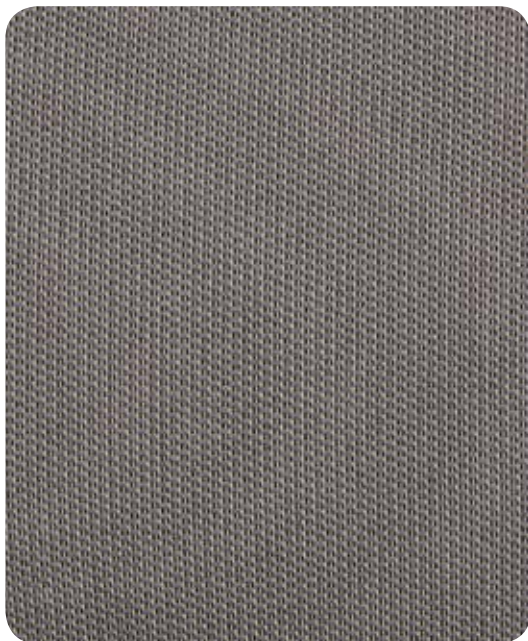

-895 | Grey



-894 | Blue

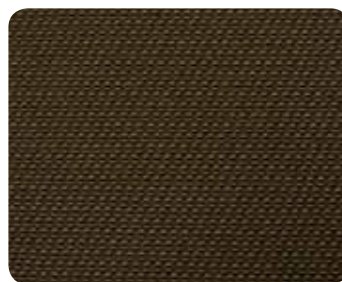

-896 | Taupe



-897 | Burgundy

contents 100% polyester • **surface abrasion** 30,000 cycles (cotton duck)
break strength warp 96 lbs, fill 99 lbs • **flammability** CA Tech Bull. 117, Section E • **treatments** N/A

*Due to differences in dye batches and variations in printing as well as viewing environments and uneven color fading there will be slight variations in color. Exact matching may not be possible.

unbeatable **service**

grade | **A**
fabric

Festival



-301 | Sangria



-303 | Dk. Pewter



-304 | Midnight Blue

contents 100% polyester • **surface abrasion** 30,000 double rubs • **break strength** warp 75 lbs, fill 150 lbs
flammability CA Tech Bull. 117, Section E UFAC Class 1 NFPA 260 • **treatments** BLOCKaide® a soil and stain repellent finish

Interlink



-104 | Ink Blue



-106 | Laguna



-107 | Flint



-108 | Autumn



-105 | Garnet

contents 100% Olefin backing: latex • **surface abrasion** 30,000+ double rubs • **break strength** warp 100 lbs, fill 125 lbs
flammability CA Tech Bull. 117, Section E UFAC Class 1 BIFMA, Class 1 • **treatments** BLOCKaide® a soil and stain repellent finish

Legend



-351 | Ebony



-353 | Merlot



-354 | Royal

contents 100% polyester • **surface abrasion** 75,000 double rubs (Wyzenbeek), 35,000 double rubs (Martindale)
break strength ASTM D5034-1995 WARP 257.3 lbs, WEFT 179.6 lbs.
flammability CA 117, Section E CS-191-53, Class 1; BIFMA FF1-78; NFPA 260-1989; UFAC, Class 1; B.S. 5852 Part 1: 1979 Ignition Source 0 Smouldering Cigarette • **treatments** soil and stain repellent finish

*Due to differences in dye batches and variations in printing as well as viewing environments and uneven color fading there will be slight variations in color. Exact matching may not be possible.

Icon



-225 | Navy

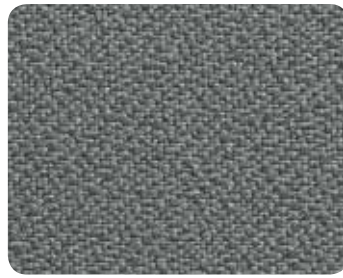

-226 | Grey

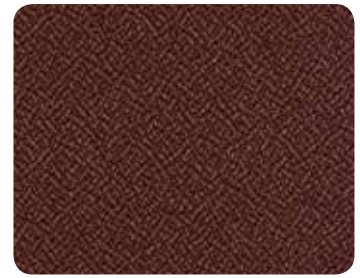

-227 | Burgundy



-231 | Black



-232 | Taupe

contents 100% polyester • **surface abrasion** 400,000 double rubs (Wyzenbeek ASTM-D-4157)
break strength warp 150 lbs, fill 88 lbs • **flammability** CA Tech Bull. 117, Section E BIFMA FF-1-78 NFPA 260-1989 UFAC, Class 1
treatments ASR2000™ a soil and stain repellent finish

Diamond

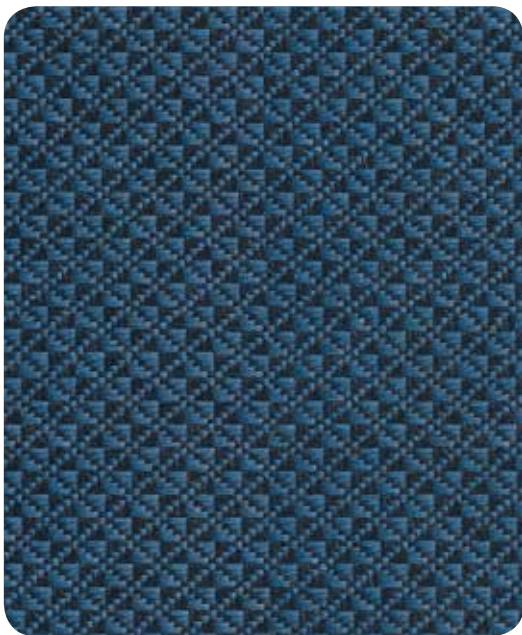

-296 | Blue Galaxy

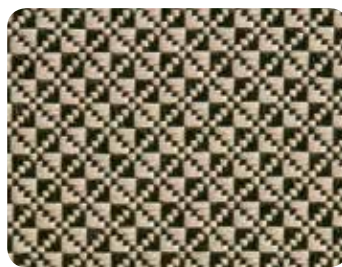

-294 | Gold Dust



-295 | Shale



-297 | Jet

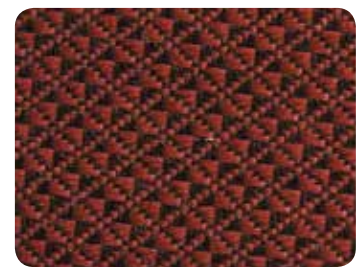

-298 | Wine

contents 100% polyester • **surface abrasion** 50,000 double rubs • **break strength** warp 300 lbs, fill 300 lbs
flammability CA Tech Bull. 117, Section E UFAC Class 1 NFPA 260 • **treatments** N/A

*Due to differences in dye batches and variations in printing as well as viewing environments and uneven color fading there will be slight variations in color. Exact matching may not be possible.

unbeatable service

grade | B
fabric

healthcare

Castillo

Castillo Antimicrobial vinyls offer the new innovative Silver Ion Technology with industry leading stain resistant properties. Available in 7 soft tone finishes, each option offers a solution for every healthcare or office environment. PVC free, and able to withstand 50,000 double rubs this unique vinyl meets the demands of high traffic lobby environments.



-K001 | Buff



-K002 | Honeydew



-K003 | Breezy



-K004 | Cream



-K005 | Java



-K006 | Metal



-K007 | Batik

• finish antimicrobial - silver based ion technology, i-clean-innovative easy clean technology •

contents 100% polyurethane • surface abrasion exceeds 200,000 double rubs (ASTM 4157) • break strength Warp 141 lbs. Fill 178 lbs. (ASTM D4034) • seam slippage Warp 50 Fill 69 (ASTM D 4034) • tear strength Warp 13 Fill 9 (ASTM D 2261-96) • pilling resistance Class 5 (ASTM D 3511) • crocking Class 5 wet & dry (AATCC 8) • colorfastness to bleach Class 5 (AATCC 130)

Twilight



-K008 | Cotton



-K009 | Sky



-K010 | Lily Pad



-K011 | Cocoa



-K012 | Brass



-K013 | Cherry



-K014 | Angora

contents 67% polyester, 33% nylon • surface abrasion 50,000 double rubs min. cotton duck • backing SBR backcoating • break strength 175 lbf min. warp & 130 lbf min fill • flammability CA Tech Bull. 117, Sec. E, NFPA 260/UFAC Fabric Classification Class 1 • treatments BLOCKaide® • seam slippage 55 lbf min. warp and 40 lbf min. fill • tear 10 lbf. warp and fill • pilling resistance Class 4 min. • color fastness to light grade 4 min. at 40 hrs

*Due to differences in dye batches and variations in printing as well as viewing environments and uneven color fading there will be slight variations in color. Exact matching may not be possible.

Fine Tune



-K100 | Luna

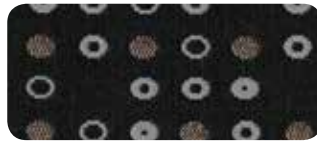

-K101 | Onyx



-K102 | Ash

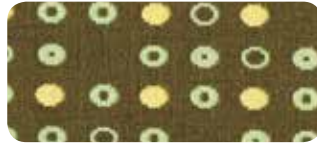

-K103 | Herb



-K104 | Cocoa



-K113 | Indigo

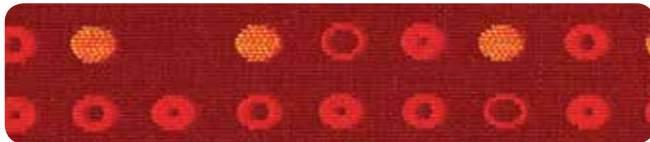

-K114 | Ruby



-K105 | Tangelo

contents 100% polyester • **surface abrasion** 40,000 double rubs
break strength WARP 80 lbs, Fill 65 lbs • **flammability** CA Tech Bull. 117, Section E UFAC Class 1 NFPA 260 • **treatments** N/A

City Park

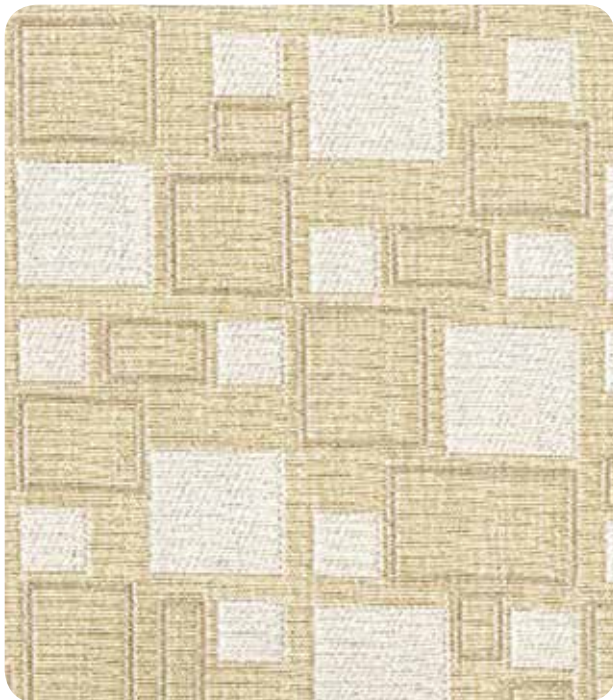

-K106 | Birch



-K107 | Domino



-K108 | Steely



-K109 | Kiwi



-K110 | Walnut



-K111 | Marigold

contents 100% polyester • **surface abrasion** 50,000 double rubs • **break strength** warp 90 lbs, fill 76 lbs
flammability CA Tech Bull. 117, Section E UFAC Class 1 NFPA 260 • **treatments** N/A

*Due to differences in dye batches and variations in printing as well as viewing environments and uneven color fading there will be slight variations in color. Exact matching may not be possible.

unbeatable service

FreeFlex® Fabric | “Comfort You Remember”

Introducing an innovative free-flex upholstery cover providing unmatched comfort. Featuring multi-directional stretching, this 100% polyester material form-fits cushions while allowing the foam to flex more than other upholstery materials. With this heightened stretch-and-return capability, FreeFlex® also contours to an individual's shape and weight for truly individualized comfort. There's no sacrifice in durability; FreeFlex® passes 70K double rubs in Wyzenbek abrasion resistance testing.

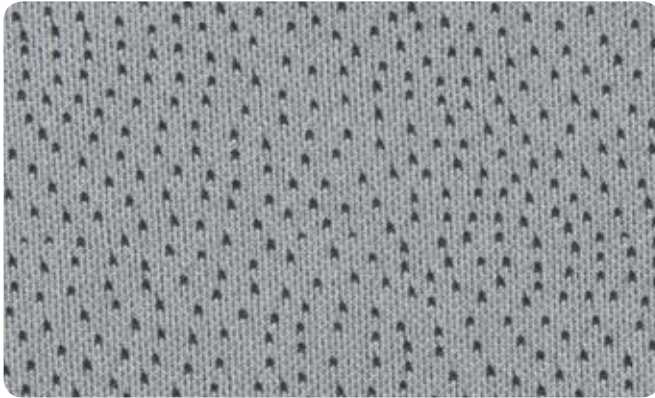

-24 | Ember



-25 | Carbon



-26 | Azul



-30 | Coal



-27 | Camel

contents 100% polyester • **surface abrasion** 50,000 double rubs (Wyzenbeek), 25,000 double rubs (Martindale)
lightfastness 20 hours, Class 4.5 (AATCC Test Method 16E) • **colorfastness** Wet - Class 4.5, Dry - Class 4.5 (AATCC Test Method 8)
flammability CA Tech Bull. 117, Section E

*Due to differences in dye batches and variations in printing as well as viewing environments and uneven color fading there will be slight variations in color. Exact matching may not be possible.

Transport



-216 | Tuxedo



-217 | Ash



-218 | Inferno



-220 | Nugget



-214 | Ivy



-215 | Rapids

contents 58% polypropylene / 42% recycled polyester • **surface abrasion** 30,000 double rubs
break strength Warp 125 lbs. Fill 150 lbs. • **flammability** CA Tech. Bull 117, Section E UFAC Class 1, NFPA 260 Class 1
treatments BLOCKaide™ a soil and stain repellent finish •

Trinket



-74 | Cabernet



-75 | Charcoal Onyx



-78 | Cadet

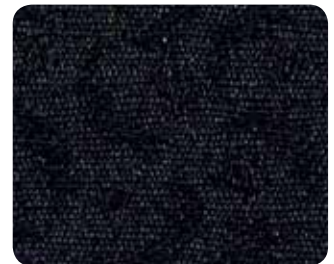

-80 | Ebony

contents Face: 58% polyester / 42% acrylic Backing: 100% acrylic • **surface abrasion** heavy duty 45,000 cycles
break strength Warp 73 lbs. Fill 50 lbs. • **flammability** CA 191-53 Tech. Bull 117, Section E UFAC Class 1
treatments Teflon™ fabric protector only by DuPont® (Teflon™ is a registered trademark of DuPont®. Only DuPont® makes Teflon™) •

Crave

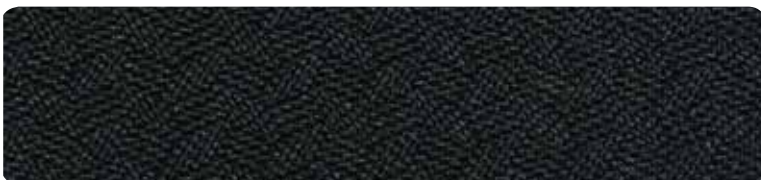

-363 | Black Triangle

contents 65% cotton / 35% polyester • **surface abrasion** 30,000 double rubs • **break strength** Warp 50 lbs. Fill 50 lbs. • **flammability** BIFMA X5.7 CA Tech. Bull 117, Section E • **treatments** stain repellent Superclear .5 oz.

*Due to differences in dye batches and variations in printing as well as viewing environments and uneven color fading there will be slight variations in color. Exact matching may not be possible.

*recommended for lounge seating **Tracery**

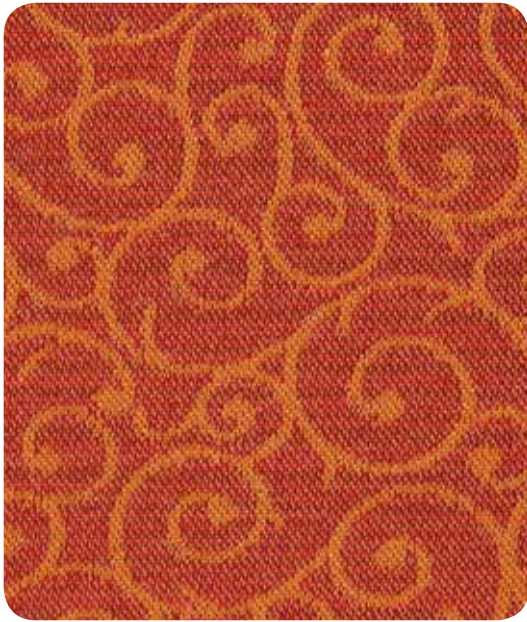

-K026 | Persimmon



-K021 | Khaki



-K022 | Chestnut



-K023 | Taupe



-K024 | Azure

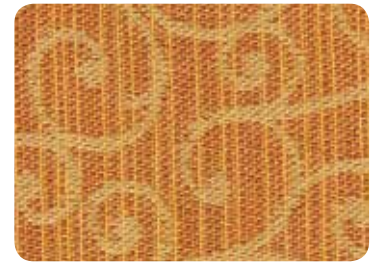

-K025 | Golden

contents 100% recycled polyester • **surface abrasion** 75,000 double rubs min. cotton duck • **backing** acrylic • **tear** 10 lbf. warp and fill • **break strength** 175 lbf min. warp & 100 lbf min fill • **flammability** CA Tech Bull. 117, Sec. E, NFPA 260/UFAC Fabric Classification Class 1 • **treatments** BLOCKaide®
seam slippage 60 lbf min. warp and fill • **tear** 10 lbf. warp and fill • **pilling resistance** Class 4 min. • **color fastness to light** grade 4 min. at 40 hrs

NEW Couture



-K052 | Tailor

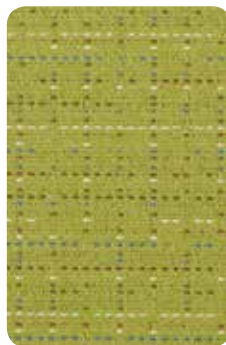

-K055 | Thread



-K054 | Thimble



-K053 | Basting



-K056 | Seam

contents 57% post-consumer recycled polyester, 25% pre-consumer recycled polyester, 18% polyester • **weight** 9.2±1.0 oz/lin. yd. • **width** 54" min. useable • **repeat** 14.5" vertical, 14" horizontal • **backing** acrylic backcoating • **treatment** stain repellent • **breaking strength** 115lbf min. warp and 85 lbf min. fill • **tear** 25 lbf warp and 30 lbf min. fill • **seam slippage** 55 lbf warp and 60 lbf fill • **pilling resistance** class 5 • **colorfastness to light** grade 4 min. at 40 hrs • **colorfastness to crocking** grade 4 min. dry & grade 3 min. wet • **wyzenbeek abrasion resistance** 100,000 double rubs cotton duck
flammability CA Tech Bull. 117-2013, Sec. 1, NFPA 260/UFAC Fabric Classification Class 1, ASTM E84

*Due to differences in dye batches and variations in printing as well as viewing environments and uneven color fading there will be slight variations in color. Exact matching may not be possible.

Key Largo



Greenguard certified, Resilience SR Stain resistance, anti-microbial and anti-bacterial protection Key Largo is a fun way to brighten the room. Engineered to withstand 250,000 double rubs, Key Largo vinyls top the list for a solution perform in the most extreme environments.



-K038 | Chocolate



-K039 | Palm

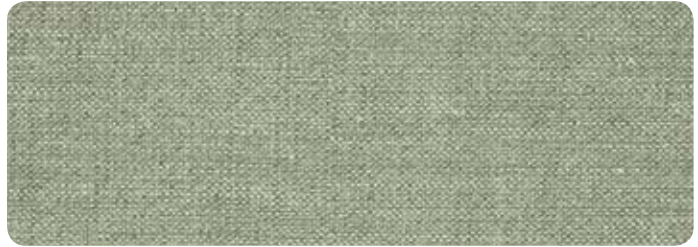

-K040 | Aqua



-K041 | Sand



-K042 | Parchment



-K043 | Tangerine

contents 100% PVC vinyl • **surface abrasion** passes 250,000 double rubs • **backing** 100% brushed polyester knit • **break strength** min warp 79, fill 56 • **flammability** passes NFPA 260 (equiv. to UFAC), Class 1, Cal. 117, Sec. E, ASTM E84 Class 2 or B (adhered), BIFMA, FMVSS 302, IMO A.652 (16) 8.2 & 8.3, may comply with Cal. Tech. Bull. 133 when combined with appropriate components • **pilling resistance** Class N/A • **color fastness to light** 1000 hrs



Recycled Fabric 100% Recycled. Wherever chairs are identified with our CF graphic, you can select 100% recycled polyester fabrics from our Cosmopolitan, Champagne, and Elements collections. All surpass 100,000 double-rub durability testing as well as CAL 117, NFPA 260 and UFAC Class 1 flammability standards, so you can protect your immediate environment as well as our planet. That's big-picture thinking. See your choices at www.officestar.net/fabrics

Element



-899 | Smoke



-900 | Putty



-901 | Plum



-902 | Sapphire



-903 | Earth

contents 100% recycled polyester • **surface abrasion** 130,000+ double rubs • **break strength** min warp 100 lbs, min fill 100 lbs • **flammability** CA Tech Bull. 117, Section E UFAC Class 1 NFPA 260 Class 1 • **treatments** N/A

*Due to differences in dye batches and variations in printing as well as viewing environments and uneven color fading there will be slight variations in color. Exact matching may not be possible.

unbeatable **service**

****fabric and finishes**

Faux Leather



-B18 | Black



-E34 | Espresso



-U9 | Red



-U22 | Smoke



-W32 | White

contents 60% Elastane Fiber and 40% Segmented Polyurethane • **flammability** CA Tech Bull. 117

Woven

Applicable to:
MST Series



-C28 | Woven Wheat



-S22 | Woven Seaweed



-W12 | Woven Charcoal



-W17 | Woven Indigo

contents 46% polyester, 18% viscose, 36% cotton • **surface abrasion** over 50000 cycles • **break strength** min warp 190 lbs, weft 120 lbs
flammability CA Tech Bull. 117 • **treatments** niddle punch+coating • **seam slippage** warp 25 lbs, weft 32 lbs
pilling resistance Class 4 • **color fastness to light** grade 4 at 20 hrs

Mid-Century Solids

Applicable to: CPR51, MAE, PAC Fabric Series and RHD51



-M17 | Green



-M21 | Blue



-M55 | Dove



-M5 | Tangerine



-M18 | Taupe



-M19 | Navy



-M52 | Cream



-M59 | Cement

contents 100% polyester • **surface abrasion** warp & weft over 30,000 cycles (ASTM-D-4157) • **break strength** warp and weft over 50 lbs. (ASTM D5034) • **flammability** CA Tech Bull. 117-2013 • **seam slippage** over 50 lbs (ASTMD 1683) • **pilling resistance** no yarn rupture @300 cycles (ASTM D3514) • **color fastness to light** dry crocking 4.5, wet crocking 4 (AATC 116) • **color to light** grade 4 at 20 hours

Milford

Applicable to:
WD483



-M24 | Dove



-M25 | Toast



-M48 | Asphalt

contents 100% polyester • **surface abrasion** 45000 rubs • **flammability** CA TB117-2013 • **seam slippage** over 50 lbs. • **break strength** warp and weft over 50 lbs. • **color fastness to crocking** dry 4 class, wet 4 class • **fastness to light** 4 at 20 hours

Idea

Applicable to:
CHA51



-V36 | Emerald Green



-V37 | Charcoal



-V38 | Midnight Blue

contents 100% polyester • **abrasion** over 15000 rubs • **flammability** CA Tech Bull. 117 -2013 • **seam slippage** over 70 lbs. • **color fastness to crocking** dry 4 class, wet 4class • **fastness to light** 4 at 20 hours • **pilling resistance** 4 class

****Swatches on this page are offered on finished goods only and not part of the custom fabric program**

Other fabric and finishes (cont.)**

unmatched selection

Linen

Applicable to: ETN & ATH Series

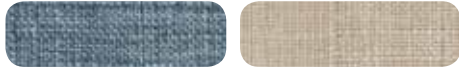

-L37 | Blue Denim -L38 | Linen

contents 100% polyester • **surface abrasion** 40,000 rubs • **break strength** 140 lbs warp, 170 lbs fill • **flammability** CA Tech Bull. 117
seam slippage warp 50 lbs, weft 45 lbs
pilling resistance Class 4 • **color fastness to light** grade 4 at 40 hrs

Deluxe Faux Leather

Applicable to: ETN Series



-PD22 | Cranberry -PD24 | Cocoa -PD26 | Pewter

contents 40% polyurethane, 60% TC fabric • **surface abrasion** 2,000 double rubs
break strength min warp 50 lbs, min fill 50 lbs • **flammability** CA Tech Bull. 117
seam slippage warp 45 lbs, weft 45 lbs • **color fastness to light** grade 4 at 20 hrs

Klein

Applicable to: DVS51, SHE and ATH Series



-K12 Klein Otter -K14 Klein Azure

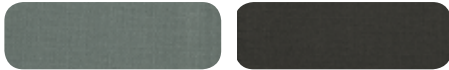

-K21 Klein Sea -K26 Klein Charcoal

contents 100% polyester
surface abrasion over 50,000 cycles • **break strength** min warp 280 lbs, weft 180 lbs • **flammability** CA Tech Bull. 117 • **treatments** knitted fabric backing • **seam slippage** warp 41 lbs, weft 46 lbs
pilling resistance Class 5 • **color fastness to light** grade 4 at 20 hrs

J&S

Applicable to: DVS51, ATH, SHE & VN Series



-L32 Linen

contents 80% polyester, 20% linen • **surface abrasion** over 25,000 cycles • **break strength** min warp 250 lbs, weft 150 lbs • **flammability** CA Tech Bull. 117 • **seam slippage** warp 35 lbs, weft 45 lbs • **pilling resistance** Class 4 • **color fastness to light** grade 4 at 40 hrs

Velvets

Applicable to: WVN Series



-V14 Azure Velvet -V17 Otter Velvet

contents 100% polyester • **surface abrasion** 40,000 double rubs (cotton duck)
break strength min warp 200 lbs, min fill 250 lbs • **flammability** CA Tech Bull. 117 • **seam slippage** warp 45 lbs, weft 35 lbs • **pilling resistance** Class 4 • **color fastness to light** grade 4 at 40 hrs

metal frames

Bristow Antique Metal Finishes



Antique Black
-AB

Antique Copper
-AC

Antique Lime
-AL

Antique Orange
AOR

Antique Pink
-AP

Antique Red
-ARD

Antique White
-AW

Antique Yellow
-AY

Antique Royal Blue
-ARB

Antique Sky Blue
-ASB

Antique Turquoise
-ATQ

Copper
-CP

Gunmetal
-GM

Matte Black
-C230

Matte Galvanized
-C210-1

Matte Gunmetal
-C209-1

Brushed Copper
New -BC

Brushed Red Copper
New -BRC

Brushed Silver
New -BS

Patterson Finishes



-3 | Black

-9 | Red

-11 | White

-16 | Mint

-18 | Orange

**Due to differences in dye batches and variations in printing as well as viewing environments and uneven color fading there will be slight variations in color. Exact matching may not be possible.

General Information

Receiving Instructions:

If shipment is received damaged, note damage on freight bill at time of acceptance and file claim for appropriate damages from the carrier. Be certain to also inspect for proper quantity of pallets/cartons and visible damage to cartons that may be evidence of concealed damage -- be certain all notations are made on original freight bill prior to signing. Concealed damage must be reported to the transportation company, in writing, within 15 days from the date of delivery. **Therefore, open all cartons and inspect product immediately upon receipt.** All damaged merchandise claims must be filed directly with the delivering carrier.

Terms of Sale: Net 30 days to firms who have established satisfactory credit; otherwise, payment in advance will be required. Past due accounts are subject to a finance charge of 1 1/2 % per month or 18% per annum.

Shipping Information: F. O. B. FACTORY

TITLE OF GOODS passes to purchaser and our responsibility ceases when shipment is accepted for transportation by any carrier from our factory. Carrier routing will be established by our Traffic Department if not indicated on purchaser's order. All shipments will be on a COLLECT basis unless otherwise instructed on order. If shipment is received damaged, note damage on carrier freight bill at time of acceptance and file claim for appropriate damages from the carrier. Concealed damage must be reported to the transportation company within 15 days from the date of delivery. All damaged merchandise claims must be filed directly with the delivering carrier.

Returned Goods: Returned merchandise will not be accepted unless authorized in writing prior to return; ship freight prepaid, in original carton, and if applicable, will be subject to a restocking charge of 20%.

C.O.M. FABRIC: Customers own material. Cost: "B" grade pricing. Fabric shipped pre-paid to Office Star® Products. Customers own material is not warranted. C.O.M. Form must accompany fabric or order.

Note: COM orders are custom, and therefore, not subject to return.

Order Changes and Cancellations: Due to expedited shipping schedules, Office Star® Products must limit customer changes and cancellations. A restocking charge of 20% will be invoiced for any product cancelled or changed after production has begun. Production normally begins 72 hours after receipt of order.

SPECIFICATIONS ARE SUBJECT TO CHANGE DUE TO MANUFACTURING IMPROVEMENTS. ALL MODELS SHIP RTA (READY-TO-ASSEMBLE) UNLESS OTHERWISE NOTED. ALL MEASUREMENTS AND WEIGHTS ARE NOMINAL UPS WEIGHT IS THE DIMENSIONAL BILLING WEIGHT FOR UPS SHIPPING

TO MAKE A WARRANTY CLAIM

Contact Parts Department via E-mail parts@officestar.net, by Fax 1-909-930-5629, or toll free parts number 1-800-950-7262, Monday through Friday 8:00 a.m. - 5:00 p.m. Pacific Time. Provide model number and description of the problem and obtain confirmation number. At its option, Office Star® Products will:

- a. Supply compatible components of current manufacture.
- b. Repair the customer's component.

It is the customer's responsibility to prepay freight on any components returned to the factory. Return freight on components covered by warranty will be paid by Office Star® Products.

Care and Cleaning:

- Vacuum or brush fabrics at least once a week. Protect from glaring sunlight.
- Use a damp cloth to clean other surface areas.
- Check screws for tightness, clean and lubricate moving parts such as chair controls and casters every three months.

Please Note:

Due to differences in dye batches and variations in printing as well as viewing environments and uneven color fading, there will be slight variations in color. Exact matching may not be possible.

OSP® Furniture veneer casegoods are to be cleaned with a solution of 9 parts water and 1 part rubbing alcohol. Laminate casegoods can be cleaned with the same solution of 9 parts water and 1 part rubbing alcohol or a non-abrasive cleaner, such as Windex. Always use a clean, non-abrasive, soft cloth.

Natural Wood is made up of millions of cells relying on absorption of pigments and dyes. The absorption rate and capacity of absorption is affected by numerous factors. While each manufacturer has its own processes and wood types and although they may call their finishes by the same name, all natural wood products are subject to variations in shade and product from different manufacturer's and may not exactly match with each other (i.e. Cherry, Mahogany, etc.).

Care and Cleaning of Leather and Vinyl Surfaces:

Many of our products feature leather and vinyl materials that may require some maintenance. For cleaning, we recommend cleaners and conditioners that are made for leather and vinyl surfaces (EX: "Rejuvenate" or similar products). Begin with a spot test on a small, discreet area to ensure the cleaner will not damage or discolor the upholstery. Once proven safe, apply the cleaner and gently scrub the surface with a microfiber cloth. After thoroughly washing the fabric, spray the conditioner and use the cloth to buff and rehydrate the coat for a pristine appearance.



Limited Product Warranty

Systems

- Lifetime on metal, plastic and wood component parts
- 5 years on electrical, lighting, laminate worksurfaces and moving parts
- 3 years on fabric

Casegoods

- 10 years against failure due to materials and workmanship
- Laminate finishes = 5 years
- Veneer finishes = 3 years
- Ascend II Electric Height Adjustable = 5 years
- PHAT Tables Pneumatic Height Adjustable = 3 years
- Desk Risers warranted 1 year
- Electrical/USB Power Stations (EXPPOW1, TUXPOW1) are warranted for a period of 1 year

Metal Filing/Pedestals/Storage

- Limited lifetime warranty against failure due to materials and workmanship

Grain, color and finishes

Variation of grain and color are natural, inherent characteristics of wood, a living material. This variation is part of the beauty of real wood and anticipated in wood furnishings. Therefore, OSP® Furniture is not warranted to match in grain or color or texture. It is a natural phenomenon for wood grain to change in color as it ages, and wood finishes are not warranted for color-fastness.

Warranty Exclusions

All warranties are limited to the original purchaser for normal commercial usage defined as a standard forty hour work week by persons weighing 250 lbs. or less. This warranty will not cover labor, freight, or damage from misuse, abuse, negligence, alteration, assembly, installation, attachments, accident, vandalism, acts of nature or any other event beyond the control of Office Star® Products. The warranty does not cover cosmetic damage that may result from normal use. Liability for incidental or consequential damage is excluded. The user assumes all risk of injury resulting from use of this product. When usage is more than 40 hours per week, a five year warranty on all parts applies.

This warranty applies only to products purchased through authorized OSP® Furniture dealers and products sold within the United States of America and the Commonwealth of Canada. This warranty does not apply to products used for rental purposes.

This warranty gives you specific legal rights, and you may also have other rights which vary from state to state.

It is the customer's responsibility to prepay freight on any components returned to the factory.

Return freight on components covered by warranty will be paid by Office Star® Products.

******* CUSTOMERS RECEIVING INSTRUCTIONS *******

INSPECT ON ARRIVAL This product has been inspected and packaged with durable internal packing and external corrugated. Responsibility for safe delivery was assumed by the carrier at time of shipment. CLAIMS FOR LOSS OR DAMAGE TO THE CONTENTS SHOULD THEREFORE BE MADE UPON THE CARRIER AS BELOW.

QUANTITY OF PIECES Check quantity of pallets/cartons received versus freight bill. Sign only for items received. NOTE ANY DISCREPANCIES ON THE FREIGHT BILL AND REQUEST A CLAIM FORM FROM THE CARRIER IMMEDIATELY.

VISIBLE DAMAGE Any external evidence of damage MUST BE NOTED ON THE FREIGHT BILL OF LADING AND SIGNED BY THE TRUCK DRIVER. Failure to adequately describe external damage may result in carrier's refusal to honor a damage claim. The form to submit a claim for the damage will be supplied by the carrier.

CONCEALED DAMAGE OR LOSS Concealed damage or loss is that which becomes apparent only after unpacking the merchandise. The merchandise may be damaged in transit due to rough and/or excessive handling even though carton may not show external damage. OPEN ALL CARTONS ALL MERCHANDISE IMMEDIATELY. If damage is discovered upon unpacking, REPORT THE DAMAGE, IN WRITING, TO THE CARRIER WITHIN 14 DAYS OF THE DELIVERY DATE AND REQUEST AN INSPECTION REPORT. Cartons and all packing must be held for inspection by carrier. Then, file a claim with the carrier as this damage or loss is the responsibility of the carrier.

Office Seating

- Lifetime on component Parts including pneumatic cylinder, control mechanism, base and casters.
- 3 years on upholstery fabric and foam against wear and deterioration.
- Leather is not warranted against routine scratching and scuffing, as leather is subject to minor blemishes in use.

Reception/Lounge Seating, Wood Guest & Active Seating

- 5 yrs structural integrity of frame • 3 yrs on seating wood finishes
- 3 years on upholstery fabric and Foam against wear and deterioration (except leather)
- Leather is not warranted against routine scratching and scuffing, as leather is subject to minor blemishes in use. Minor variations in color, texture and grain are a natural part of leather hides, and therefore, are not covered by this warranty.
- C.O.M. Fabrics are not warranted by Office Star® Products

SPACE[®] LIMITED WARRANTY

Space chairs are warranted from the date of purchase against failure due to material and workmanship as follows:

- Lifetime on component Parts Including pneumatic cylinder, control mechanism, base and casters.
- 3 Years on upholstery fabric and foam against wear and deterioration
- Leather is not warranted against routine scratching and scuffing, as leather is subject to minor blemishes in use

All warranties are limited to the original purchaser for normal commercial usage defined as a standard forty hour work week by persons weighing 275 lbs. or less. The 63-37A773HM, 63-E37A773HL, 75-7A773, 75-37A773, 75-47A773 and 839-11B35WA are for persons weighing 400 lbs. or less, the 818 & select 829's with self-adjusting mechanism are 300 lbs. or less and the 15-37A720D is 325 lbs. or less. This warranty will not cover labor, freight or damage from misuse, abuse, negligence, alteration, accident, vandalism, rusting, acts of nature or any other event beyond the control of Office Star[®] Products. The warranty does not cover cosmetic damage that may result from normal use. Liability for incidental or consequential damages is excluded. The user assumes all risk of injury resulting from use of this product. When usage is more than 40 hours per week, a five year warranty on all parts applies. This warranty gives you specific legal rights, and you may also have other rights which vary from state to state.

All Space chairs meet or exceed ANSI BIFMA standards.

It is the customer's responsibility to prepay freight on any components returned to the factory. Return freight on components covered by warranty will be paid by Office Star Products.

pro·line II[®] Warranty

PRO·LINE II[®] LIMITED WARRANTY

Pro-Line II[®] chairs are warranted from the date of purchase against failure due to material and workmanship as follows:

- Lifetime on component parts including pneumatic cylinder, control mechanism, base and casters.
- 3 Years on upholstery fabric and foam against wear and deterioration.
- Leather is not warranted against routine scratching and scuffing, as leather is subject to minor blemishes in use.

Elite chairs (54666) are warranted from the date of purchase against failure due to material and workmanship as follows:

- 5 Years on component parts including pneumatic cylinder, control mechanism, base and casters.
- 2 Years on upholstery fabric and foam against wear and deterioration.

Pro-Line II[®] Desks are warranted from the date of purchase against failure due to material and workmanship as follows:

- Prado Collection = 5 years
- Prado Power/USB Stations (PRDPOW1) = 1 year
- Horizon Desking = 3 years
- Height Adjustable Tables (HAT) and PHT Tables = 3 years
- Height Adjustable Manual Desk Riser (PRD3529) = 1 year

Grain, color and finishes

Variation of grain and color are natural, inherent characteristics of wood, a living material. This variation is part of the beauty of real wood and anticipated in wood veneer furnishings. Therefore, Pro-Line II[®] furniture is not warranted to match in grain or color or texture. It is a natural phenomenon for wood grain to change in color as it ages, and wood finishes are not warranted for colorfastness.

All warranties are limited to the original purchaser for normal commercial usage defined as a standard forty hour work week by persons weighing 275 lbs. or less. The 54666 is for persons weighing 300 lbs. or less. The 39200, 39202, 81308, 81608, 69220C, 69226-EC3 and 69227-3M are for persons weighing 400 lbs. or less. This warranty will not cover labor, freight or damage from misuse, abuse, negligence, alteration, accident, vandalism, rusting, acts of nature or any other event beyond the control of Office Star[®] Products. The warranty does not cover cosmetic damage that may result from normal use. Liability for incidental or consequential damages is excluded. The user assumes all risk of injury resulting from use of this product. When usage is more than 40 hours per week, a five year warranty on all parts applies. This warranty gives you specific legal rights, and you may also have other rights which vary from state to state.

All Pro-Line II[®] chairs meet or exceed ANSI BIFMA standards.



WORK SMART® LIMITED WARRANTY

Work Smart® chairs are warranted from the date of purchase against failure due to material and workmanship as follows:

- 15 Years on all non-moving metal parts.
- 5 Years on component parts including control mechanisms, pneumatic cylinders, wood, plastic parts, base and casters.
- 3 Years on upholstery fabric and foam against wear and deterioration.
- Leather is not warranted against routine scratching and scuffing, as leather is subject to minor blemishes in use.

Office Star® Reception Tables are warranted from the date of purchase against failure due to material and workmanship as follows:

- 5 Years on structural integrity.
- 3 Years on wood finishes.

Office Star® Reception Seating is warranted from the date of purchase against failure due to material and workmanship as follows:

- 5 Years on Structural integrity of frame.
- 3 Years on wood finishes.
- 1 Year on upholstery fabric and foam against wear and deterioration.
- Leather is not warranted against scratching and scuffing, as leather is subject to minor blemishes in use. Minor variations in color, texture and grain are a natural part of leather hides, and therefore are not covered by this warranty.

Breakroom Collection:

- 15 Years on all non-moving metal parts.
- Designed for indoor use only

All warranties are limited to the original purchaser for normal commercial usage defined as a standard forty hour work week by persons weighing 250 lbs. or less. The BC9601 is for persons weighing 300 lbs. or less. The BC9602 is for persons weighing 400 lbs. or less. The BC9603 is for persons weighing 500 lbs. or less. EX1098, EC1283C & ECH12801 are for persons weighing 350 lbs. or less. This warranty will not cover labor, freight or damage from misuse, abuse, negligence, alteration, accident, vandalism, rusting, acts of nature or any other event beyond the control of Office Star® Products. The warranty does not cover cosmetic damage that may result from normal use. Liability for incidental or consequential damages is excluded. The user assumes all risk of injury resulting from use of this product. When usage is more than 40 hours per week, a two year warranty on all parts applies. This warranty gives you specific legal rights, and you may also have other rights which vary from state to state.

All Work Smart® chairs are built to meet or exceed ANSI BIFMA standards.

◆ GENERAL CHAIR WARRANTY

Office Star General chairs are warranted from the date of purchase against failure due to material and workmanship as follows:

- 2 Years on all non-moving metal parts.
- 1 Year on component parts including control mechanisms, pneumatic cylinders, wood, plastic parts, base and casters.
- 1 Year on upholstery fabric and foam against wear and deterioration.
- We cannot warrant leather against routine scratching and scuffing, as all leather is subject to minor blemishes in use.

All warranties are limited to the original purchaser for normal residential usage by persons weighing 200 lbs. or less. This warranty will not cover labor, freight or damage from misuse, abuse, negligence, alteration, accident, vandalism, rusting, acts of nature or any other event beyond the control of Office Star® Products. The warranty does not cover cosmetic damage that may result from normal use. Liability for incidental or consequential damages is excluded. The user assumes all risk of injury resulting from use of this product. This warranty gives you specific legal rights, and you may also have other rights which vary from state to state.

Office Seating under “◆ General Warranty” are not intended for commercial use (40-hour work week).

It is the customer’s responsibility to prepay freight on any components returned to the factory. Return freight on components covered by warranty will be paid by Office Star® Products.

MULTI PURPOSE TABLE AND CHAIR LIMITED WARRANTY

Office Star® Products Warrants, to the original purchaser, all “Work Smart® Series Multi Purpose Tables and Chairs” to be free from defects in material and workmanship for a period of ten years. This warranty will not cover labor, freight or damage from misuse, abuse, negligence, alteration, accident, vandalism, rusting, acts of nature or any other event beyond the control of Office Star® Products. This warranty does not cover cosmetic damage that may result from normal use. Liability for incidental or consequential damages is excluded. The user assumes all risk of injury resulting from use of this product. All Table Warranties are limited to 350 lbs. of distributed weight over the entire table top surface. All chair warranties are limited to normal usage by persons weighing 200 lbs. or less. This warranty gives you specific legal rights, and you may also have other rights which vary from state to state.

There are many features to consider when selecting the perfect chair to suit your needs. The following symbols will help you choose the product enhancements that are right for you. These symbols are referenced throughout this catalog to help you quickly identify each chair's features. The descriptions of the features shown are meant to be general explanations. The actual functions of the features may vary slightly.

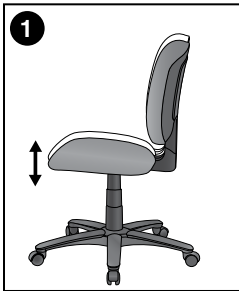

1
Pneumatic Seat Height Adjustment Allows quick and easy adjustment regulates height of chair relative to floor.

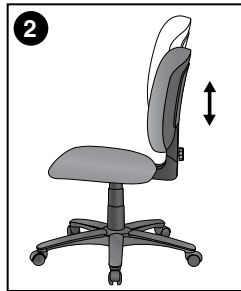

2
Back Height Adjustment Allows positioning of lumbar support within a fixed range to alleviate back stress.

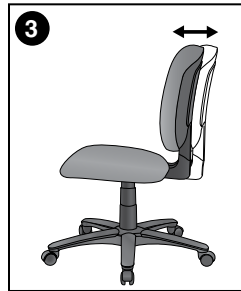

3
Seat Depth Adjustment Positions chair back relative to seat to reduce pressure on the buttocks and thighs for both taller and shorter users.

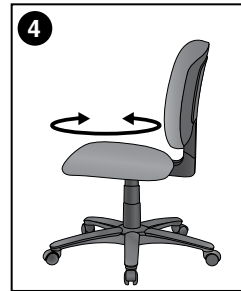

4
360° Swivel Chair rotates a full 360° in either direction for ease of motion. Standard on every executive and task chair.



5
Tilt Pivot point located directly above center of chair base (white dot indicates pivot point).

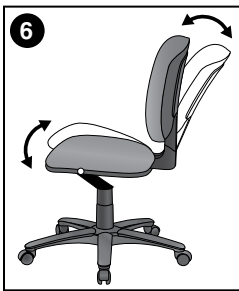

6
Mid-Pivot Knee Tilt Pivot point located slightly ahead of center of gravity (white dot indicates pivot point). Allows user to recline at a slightly more relaxed angle than conventional center tilt.



7
2-to-1 Synchro Tilt Back reclines at 2-to-1 ratio to seat angle. Allows user to recline while keeping seat cushion relatively level to floor.

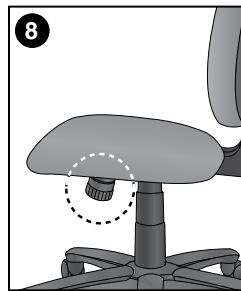

8
Tilt Tension Controls rate and ease with which chair reclines for different weights and strengths of users.

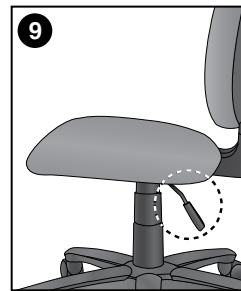

9
Tilt Lock Locks out tilt function when chair is in upright position.

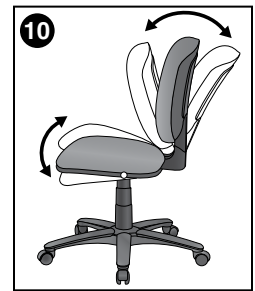

10
Multi-Task Control Adjusts seat and back angles with a single lever (infinite locking within a fixed range), reducing fatigue in back and thighs.



11
Dual Function Two levers modify:

- Angle of back relative to seat
- Forward tilt (for keyboard-intensive applications).



12
Flex Back Back tilts with pressure. Allows user to recline while keeping seat cushion level to floor. Includes Flex tension Adjustment

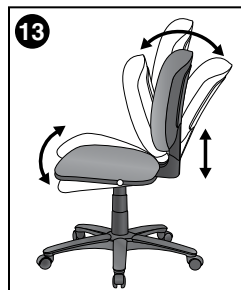

13
Multi-Function Three levers to modify angle of back relative to the seat, control tilt and forward tilt for keyboard intensive activities. Tilt is free float or locking within a fixed range. This control may also have ratchet back height adjustments.



14
Auto Adjusting Synchro Tilt This self adjusting control uses your weight to balance the force needed to recline the back. Back tilt is controlled by a single lever which will lock in 5 positions. When tilting the seat tilts at a 4-to-1 ratio to the back.



15
Seat Slider Allows adjustment of seat to move forward and back to its original position.

Due to changing costs not within our control, which include but are not limited to import tariffs, government mandated costs both domestically and from factory country of origin, costs of raw materials, costs of transportation, and manufacturing costs, while providing a 30 day notice, Office Star® Products reserves the right to change prices accordingly.



CORPORATE OFFICE & WAREHOUSE

P. O. Box 3520, Ontario, CA 91761
p. 909.930.2000 | p. 800.950.7262
f. 909.930.5349

**KENTUCKY
DISTRIBUTION CENTER**

5100 Jeff Commerce Drive, Suite102
Louisville, KY 40219
p. 909.930.5924 | f. 909.930.9594

**NEW JERSEY
DISTRIBUTION CENTER**

1 Oxford Drive, Moonachie, NJ 07074
p. 201.393.0900 | p. 800.872.3375
f. 201.393.0955



For the latest updates, follow us on



@officestarprouducts

www.officestar.net